







# More Precision

**colorSENSOR** // True Color Measuring Systems





	For textiles, paper, metallic paint, sand, granulate, wood veneers or masterbatch
	For structured and metallic-effect surfaces
	Homogeneous illumination of the measuring point
	Max. working distance of 100 mm (on strongly reflecting surfaces)
	Very precise positioning of the detection point

With the circular sensor, the light emitted by the controller is sent as an illuminated ring at an angle of 11° or 34° (depending on type) to the surface of the object to be tested. The diffuse back reflection (surface color) of the sample is detected by the sensor at 0° (parallel) to the surface and transmitted to the controller via an optical fiber. The ring illumination makes it possible to detect the diffuse color reflex regardless of structure or reflection. The sensors are available with different illumination angles and different spot sizes. Therefore, it is possible to measure colors with a repeatability of  $\Delta E \leq 0.3$  in relative terms up to a working distance of 100 mm. Other sheaths and cable lengths are optionally available.

The circular sensor opens up new fields of application for the colorSENSOR CFO product series. Combined with the high performance of the CFO series, the ring illumination provides even more precision due to uniform illumination. This compact combination can be universally used but is also suitable for special solutions (customer-specific adaptations). The homogeneous illumination mainly offers advantages on strongly structured or shiny-metallic surfaces while providing highest precision when distinguishing colors such as white shades. The circular sensor offers many advantages in terms of performance and installation possibilities. Due to the external controller, less installation space is required at the measuring point.

Due to the standard FA connection, the optical fiber is also compatible with other controllers (previous series such as LT or WLCS).

#### Measurement geometry

Circular sensor R34°c:0°, R11°c:0°

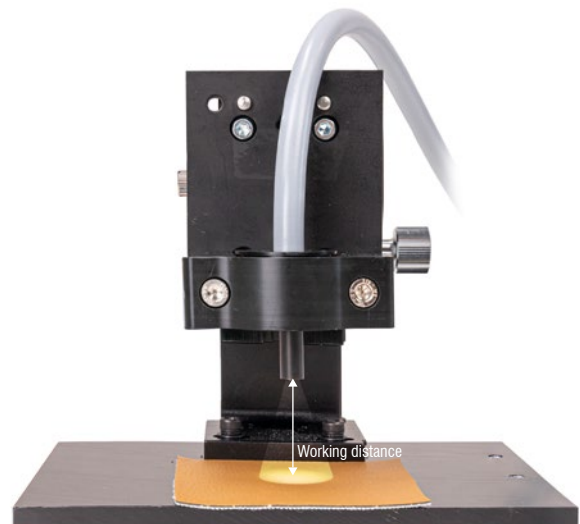
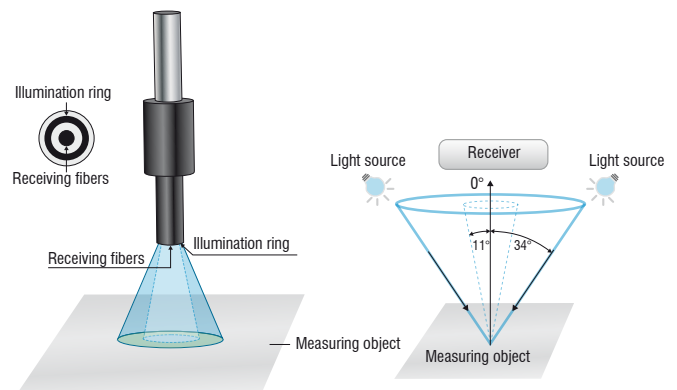

The circular sensor allows an evenly illuminated larger measurement spot.

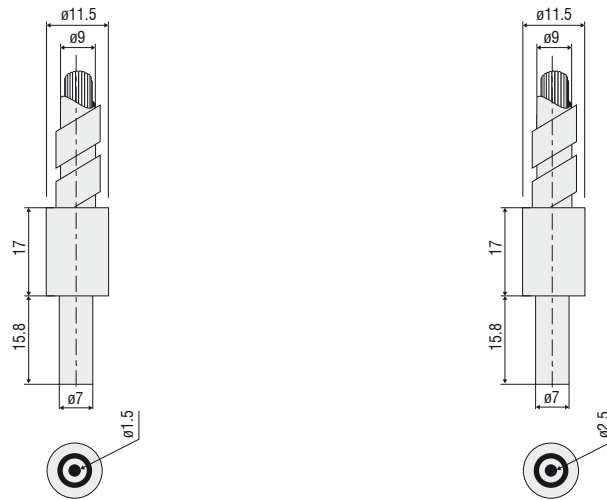

Model		CFS2-M11	CFS2-M20
Part number		10814900	10814895
Type of sensor		Circular sensor	
Working distance <sup>1)</sup>	Start	10 mm	10 mm
	Optimal	30 mm	30 mm
	End	60 mm	100 mm
Measurement spot diameter <sup>1)</sup>	Start	13 mm	11 mm
	Optimal	35 mm	20 mm
	End	70 mm	66 mm
Light spot diameter <sup>1)</sup>	Start	18 mm	11 mm
	Optimal	48 mm	22 mm
	End	85 mm	70 mm
Repeatability in rotation <sup>1) 2) 3)</sup>		$\Delta E \leq 0.5$	
Measurement geometry		R34°c:0°	R11°c:0°
Min. target size (flat)		Ø 13 mm	Ø 11 mm
Minimum curvature radius of target (curved)		130 mm	110 mm
Sensitivity	Distance <sup>1) 3)</sup>	< 3 $\Delta E$ / mm	< 2.5 $\Delta E$ / mm
	Tilt angle <sup>1) 3)</sup>	< 0.3 $\Delta E$ / °	
	Ambient light <sup>1) 3)</sup>	< 0.3 $\Delta E$ / 1,000 lx	
Permissible ambient light <sup>1) 3)</sup>		< 9,500 lx	< 4,500 lx
Max. tilt angle <sup>1) 3)</sup>		$\pm 45^\circ$	
Connection		integrated fiber-optic cable (axial) with metal-silicone (T) sheath, standard length 1.2 m; other lengths 0.3 ... 2.4 m optionally available	
Mounting		FA (M18x1)	
Temperature range	Storage / operation	Sensor head: -10 °C ... +80 °C; cable: -60 °C ... +180 °C	
Humidity (non-condensing)		20 ... 80 % r.H.	
Protection class (DIN-EN 60529)		IP64	
Material		Aluminum black anodized, glass, glass fiber bundle with metal-silicone coating (T)	
Weight		170 g	200 g
Compatibility		CFO controller (LT, WLCS, FES)	
Features		All variants are also available with different cable sheath, length 0.3 ... 2.4 m, vibration protection, IP protection, suitable for drag chains and for temperature ranges up to 2,000 °C. In combination with a pressure-tight feed-through, a stainless steel sheath and T250° bonding, vacuum applications down to 10-5 mbar are also possible.	

The specified data apply to a white, diffuse reflecting surface (zenith white reference)

<sup>1)</sup> In combination with colorSENSOR CFO200 and a repeatability of  $\Delta E \leq 0.3$

<sup>2)</sup> On titanium pearl mica from a distance of 30 mm

<sup>3)</sup> Valid for optimal working distance

## Sensors and Systems from Micro-Epsilon



Sensors and systems for displacement, distance and position



Sensors and measurement devices for non-contact temperature measurement



Measuring and inspection systems for metal strips, plastics and rubber



Optical micrometers and fiber optics, measuring and test amplifiers



Color recognition sensors, LED analyzers and inline color spectrometers

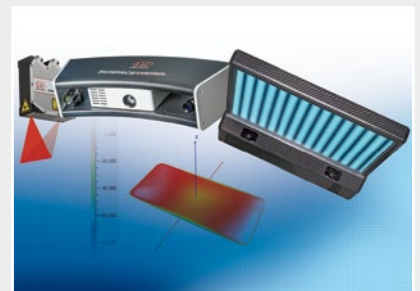

3D measurement technology for dimensional testing and surface inspection

