



More Precision

thermoMETER // Non-contact infrared temperature sensors





thermoMETER CX

OEM temperature sensor with integrated controller

- Measuring range from -30 °C to 900 °C
- High resolution model available (CX-SF15-C8 with 0.025 °C)
- Easy two-wire installation
- Optional USB interface and software for programming
- Large supply voltage range: 5-30 VDC
- Optical resolution from 15:1, 22:1
- Simultaneous two-wire output and digital communication
- Alarm output (0-30 V / 500 mA)
- Connection dimension 1.5" for easy replacement of present sensors

Optical specifications thermoMETER CX

□ = smallest spot size / focal point (mm)

Standard Focus										
SF15	15:1	6.5	11.5	6.6	21.6	26.6	34.9	43.2	51.4	59.7
SF22	22:1	6.5	10.5	14.4	18.4	22.3	26.3	30.2	34.2	38.1
	distance in mm	0	100	200	300	400	500	600	700	800
Close Focus										
CF15	15:1	7	3.9	0.8	4.7	8.6	12.5	16.4	20.3	24.2
CF22	22:1	7	3.8	0.6	4.4	8.2	12	15.8	19.6	23.4
	distance in mm	0	5	10	15	20	25	30	35	40

Model	CX-SF15-C8	CX-SF22-C8
Optical resolution	15:1	22:1
Temperature range ¹⁾	-20 °C to 150 °C	-30 °C to 900 °C
Spectral range	8 to 14 μm	
System accuracy ²⁾	±1 % or ±1 °C	±1 % or ±1.4 °C
Repeatability ²⁾	±0.3 % or ±0.3 °C	±0.5 % or ±0.7 °C
Temperature resolution	0.025 °C ³⁾	0.1 °C
Response time	150 ms (95 %)	
Emissivity/gain ¹⁾	0.100 to 1.100	
Transmissivity ¹⁾	0.100 to 1.100	
Signal processing ¹⁾	peak hold, valley hold, average; extended hold function with threshold and hysteresis	
Certificate of calibration	optional	
Outputs/analog	4 to 20 mA	
Output/alarms	0 to 30 V / 500 mA (open collector)	
Outputs/digital (optional)	USB	
Output/impedance	max. 1000 Ω (depends on supply voltage)	
Cable length	8 m	
Power supply	5 to 30 VDC	
Protection class	IP65 (NEMA-4)	
Ambient temperature	-20 °C to 75 °C	
Storage temperature	-40 °C to 85 °C	
Relative humidity	10 to 95 %, non-condensing	
Vibration	IEC 68-2-6: 3 G, 11 to 200 Hz, any axis	
Shock	IEC 68-2-27: 50 G, 11 ms, any axis	
Weight	350 g	

¹⁾ adjustable via software

²⁾ ambient temperature 23 ±5 °C; whichever is greater; object temperature ≥ 0 °C;

³⁾ with object temperature < 100 °C; time constant from > 0.2 s

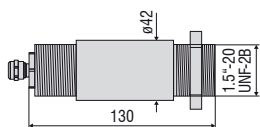

Product identification

CX -	SF15-	C8
		Cable length [8 m]
		Focus [SF / CF]
thermoMETER CX		

Accessories page 54 - 55

- Ancillary CF lens
- Protective window
- Air purge collar
- USB kit



Mechanical accessories CS / CSmicro / CSmicro 2W

Art. No.	Model	Description
2970279	Emissivity	Mounting bracket, fixed
2970280	TM-AB-CS	Mounting bracket, adjustable
2970281	TM-MB-CS	Mounting bolts with M12x1 thread
2970282	TM-MG-CS	Mounting fork, adjustable in 2 axes, with M12x1 fastening
2970283	TM-AP-CS	Air purge collar for 10:1 sensors
2970284	TM-APL-CS	Air purge collar, laminar
2970285	TM-APLCF-CS	Air purge collar, laminar with integrated ancillary CF lens
2970286	TM-RAM-CS	Right angle mirror for measurements 90 °C to the sensor axis
2970287	TM-USBK-CS	USB kit: USB programming adapter, CompactConnect software

Optical accessories CS / CSmicro / CSmicro 2W

2970277	TM-CF-CS	Ancillary CF lens for CS models
2970278	Aluminum	Protective window for CS models

Calibration CS / CSmicro / CSmicro 2W

2970288	TM-CERT-CS	Certificate of calibration
---------	------------	----------------------------

Mechanical accessories CX

Art. No.	Model	Description
2970307	TM-AP-CX	Air purge collar, aluminum (anodized)
2970321	TM-FB-CX	Mounting bracket, adjustable in 1 axis, stainless steel
2970322	TM-AB-CX	Mounting bracket, adjustable, in 2 axes, stainless steel
2970311	TM-USBK-CX	USB kit: USB programming adapter, CompactConnect software

Optical accessories CX

2970302	TM-CF-CX	Ancillary CF lens for CX models
2970303	TM-PW-CX	Protective window for CX models

Calibration CX

2970323	TM-CERT-CX	Certificate of calibration
---------	------------	----------------------------

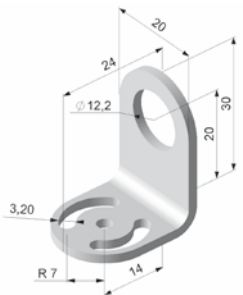

TM-FB-CS mounting bracket, fixed

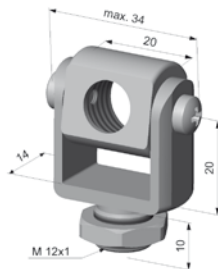

TM-MG-CS Mounting fork with M12x1 thread, adjustable in two axes

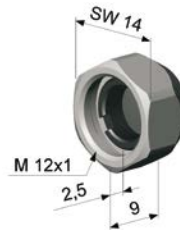

TM-CF-CS Ancillary CF lens (only for LT models)

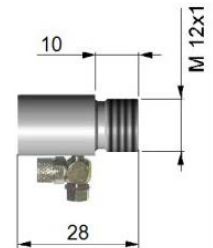

TM-AP-CS Air purge collar for 10:1 sensors

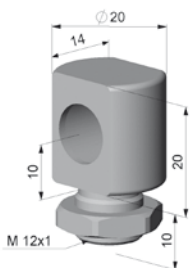

TM-MB-CS Mounting bolts with M12x1 thread adjustable in one axis

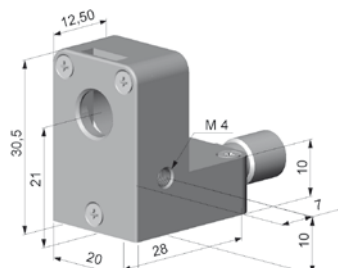

TM-APL-CS Air purge collar, laminar

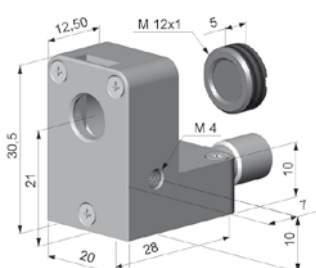

TM-APLCF-CS Air purge collar, laminar with integrated ancillary CF lens

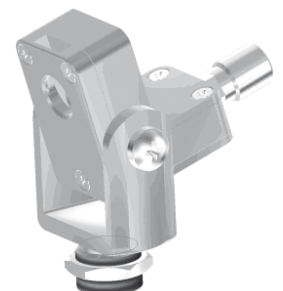

TM-APL-CS Air purge collar, laminar
TM-MG-CS Mounting fork

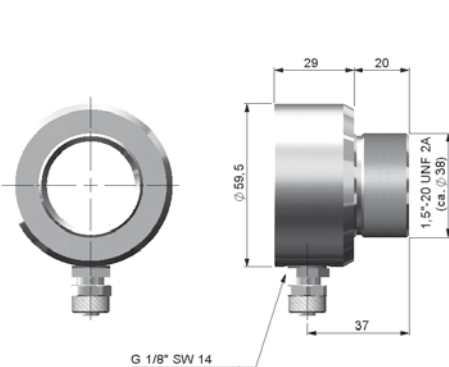

TM-AP-CX Air purge collar for CX sensors

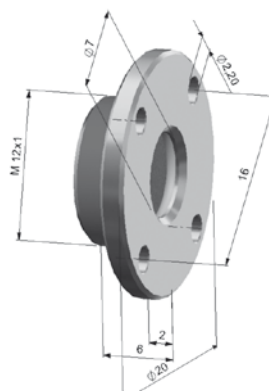

TM-CF-CX Ancillary CF lens, TM-PW-CX Protective window



TM-RAM-CS Right angle mirror

Further IR temperature measurement devices from Micro-Epsilon



thermoIMAGER TIM
Compact USB thermal imaging cameras
for precise thermography



thermoMETER CTVideo/CSVideo
Infrared temperature sensors with crosshair
laser sighting and video output



thermoMETER Handheld
Innovative handheld pyrometer with laser
sighting for inspection and maintenance