









# More Precision

**confocalDT** // Confocal chromatic sensor system





-  **Fast confocal controller: up to 25kHz**
- INTERFACE** **Ethernet / EtherCAT / RS422 / PROFINET / Ethernet/IP / Analog**
-  **Fast surface compensation**
-  **Configuration via web interface**
-  **Submicrometer resolution**
-  **Multi-layer thickness measurement**
-  **Robust design with passive cooling**

confocalDT IFC2461 systems are used for complex distance and thickness measurements. The IFC2461 controller is equipped with enhanced, optimized optical components for measuring rates up to 25 kHz without having to use an external light source. The high light intensity enables reliable measurements on difficult surfaces, e.g., on matt black objects or for multi-layer thickness measurement of glass. The active exposure regulation feature in the CCD line is for accurate, fast surface compensation on changing surfaces during dynamic measurement processes.

The controller can be operated with any IFS sensor and is available as a standard version for distance and thickness measurements or as a multi-peak version for multi-layer measurements.

Due to a user-friendly web interface, no additional software is necessary to configure the controller and the sensors. Data output is via Ethernet, EtherCAT, RS422 or analog output.

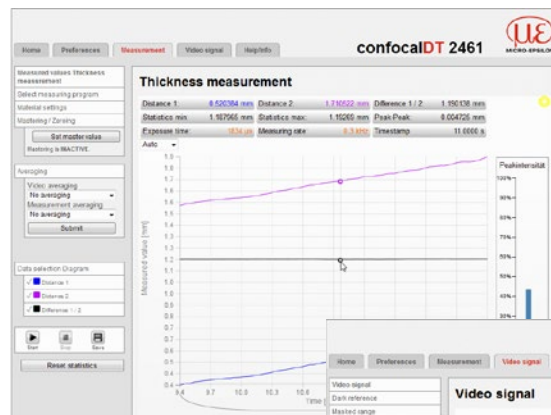

All settings are performed in the web interface. For thickness measurements, materials are stored in an expandable materials database.

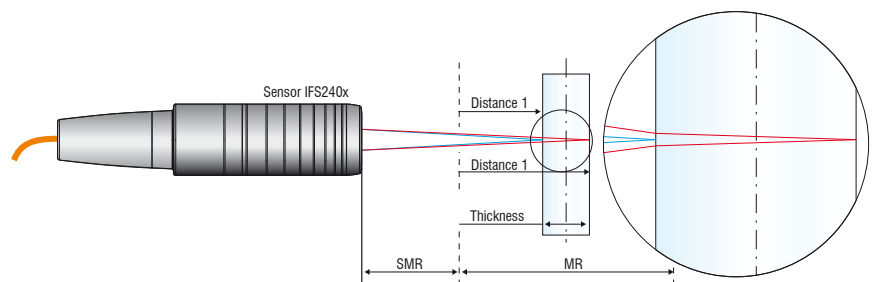
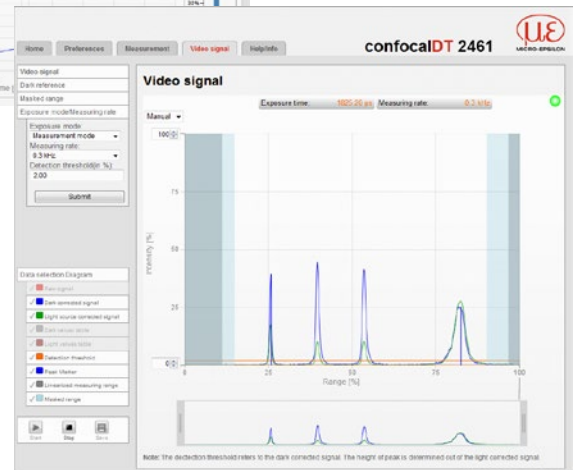

Model		IFC2461	IFC2461MP
Resolution	Ethernet/EtherCAT		1 nm
	RS422		18 bit
	analog		16 bits (teachable)
Measuring rate		continuously adjustable from 100 Hz to 25 kHz	
Linearity		typ. < ±0.025 % FSO (depends on sensor)	
Multi peak measurement		1 layer	5 layers
Light source		internal white LED	
No. of characteristic curves		up to 20 characteristic curves for different sensors per channel, selection via table in the menu	
Permissible ambient light <sup>1)</sup>		30,000 lx	
Synchronization		yes	
Supply voltage		24 VDC ± 15 %	
Power consumption		approx. 10 W	
Signal input		sync-in / trig-in; 3x encoder (A, B, index)	
Digital interface		Ethernet; EtherCAT; RS422; PROFINET <sup>2)</sup> ; EtherNet/IP <sup>2)</sup>	
Analog output		Current: 4 ... 20 mA; voltage: 0 ... 10 V / -10 ... +10 V (16 bit D/A converter)	
Switching output		Error1-Out, Error2-Out	
Digital output		sync-out	
Connection	optical	pluggable optical fiber via E2000 socket, length 2 m ... 50 m, min. bending radius 30 mm	
	electrical	3-pin supply terminal strip; Encoder connection (15-pin, HD-sub socket, max. cable length 3 m); RS422 connection socket (9-pin, Sub-D, max. cable length 30 m); 3-pin output terminal strip (max. cable length 30 m); 12-pin I/O terminal strip (max. cable length 30 m); RJ45 socket for Ethernet / EtherCAT (max. cable length 100 m)	
Installation		free-standing, DIN rail mounting	
Temperature range	Storage	-20 ... +70 °C	
	Operation	+5 ... +50 °C	
Shock (DIN EN 60068-2-27)		15g / 6 ms in XYZ axis, 1000 shocks each	
Vibration (DIN EN 60068-2-6)		2 g / 20 ... 500 Hz in XYZ axis, 10 cycles each	
Protection class (DIN EN 60529)		IP40	
Material		Aluminum	
Weight		approx. 2.2 kg	
Compatibility		compatible with all confocalDT sensors	
No. of measurement channels		1	
Control and display elements		ON/OFF multifunction button (as well as dark alignment and reset to factory setting after 10 s); 4x LEDs for intensity, range, status, supply voltage	
Features		particularly light-intensive	

FSO = Full Scale Output

<sup>1)</sup> Illuminant: light bulb

<sup>2)</sup> Optional connection via interface module (see accessories)

IFC2461 controller

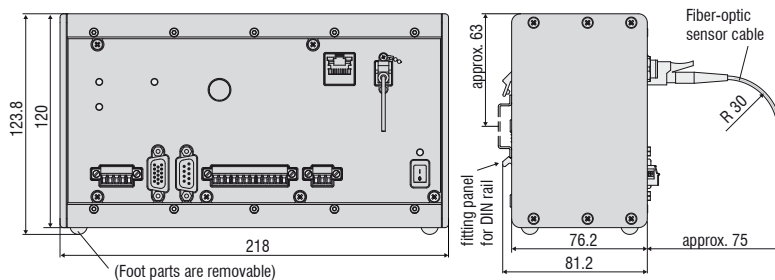

## System design

### The confocalDT system consists of:

- Sensor IFS240x
- Controller IFC24xx
- Fiber optic cable C24xx

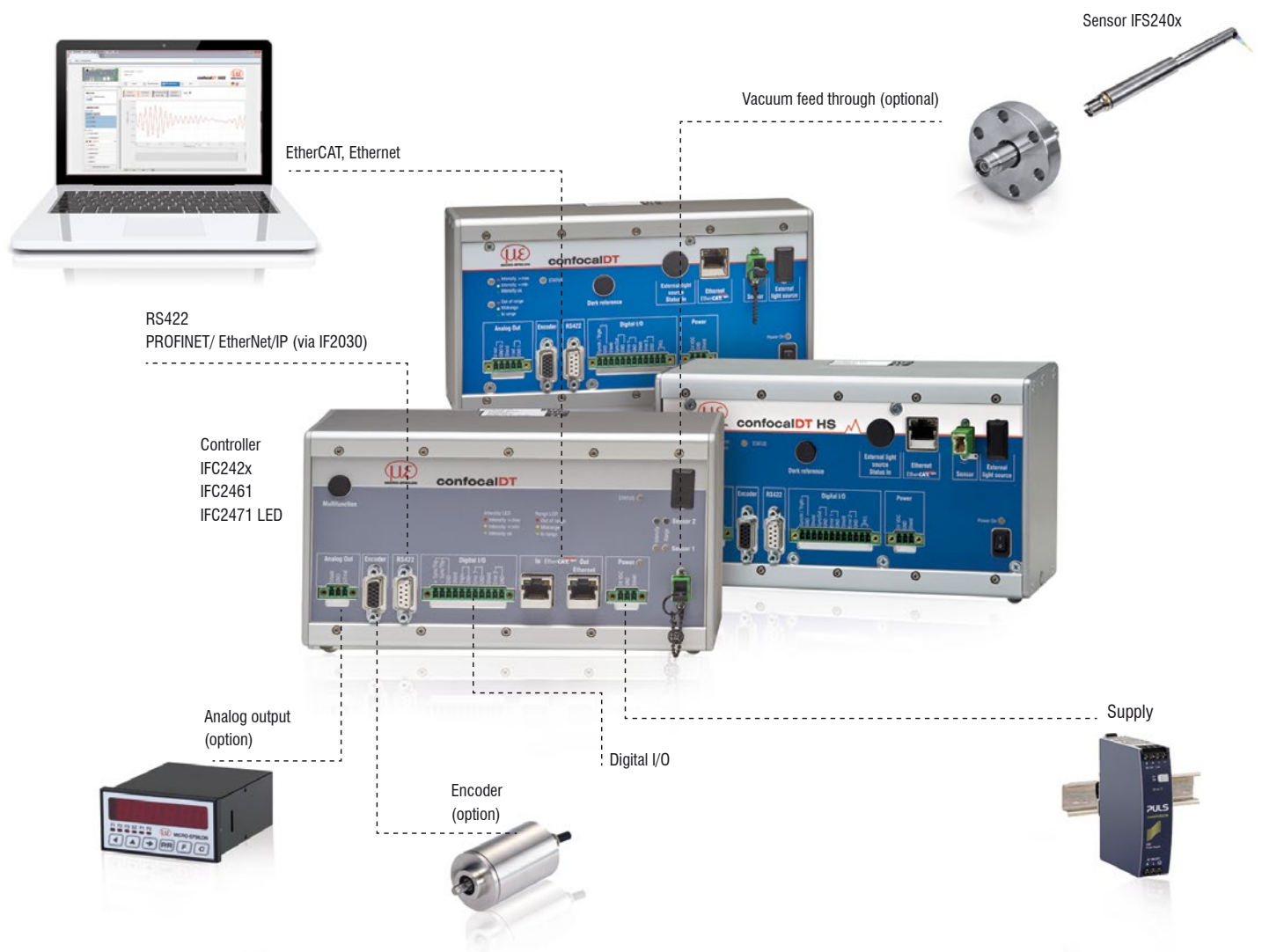

### Customer-specific modifications

Application examples are often found where the standard versions of the sensors and the controllers are performing at their limits. To facilitate such special tasks, it is possible to customize the sensor design and to adjust the controller accordingly. Common requests for modifications include changes in design, mounting options, customized cable lengths and modified measuring ranges.



### Possible modifications

- Sensors with connector
- Cable length
- Vacuum suitability up to UHV
- Specific lengths
- Customer-specific mounting options
- Optical filter for ambient light compensation
- Housing material
- Measuring range / Offset distance

### Vacuum setup

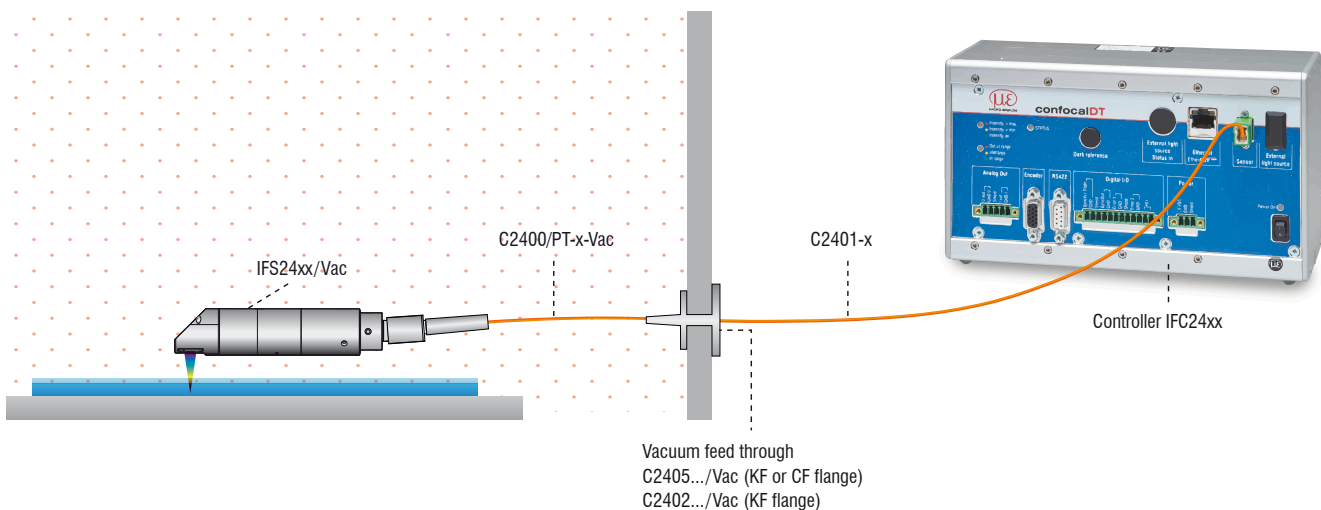

**Accessories: mounting adapter**

MA2402 for sensors 2402

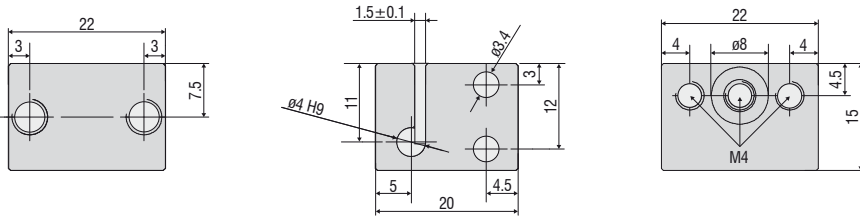

**Accessories: mounting adapter**

MA2403 for sensors 2403

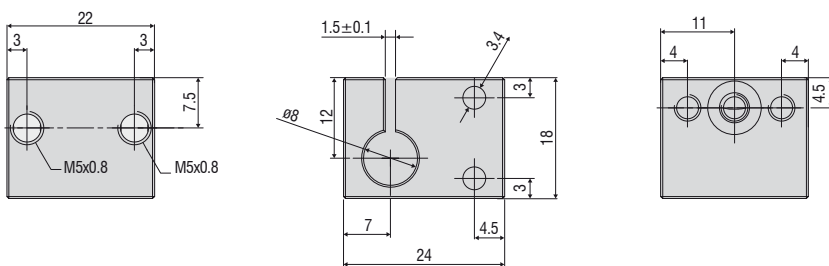

**Accessories: mounting adapter**

MA2404-12 for sensors IFS2404-2 / IFS2404/90-2 / IFS2407-0,1

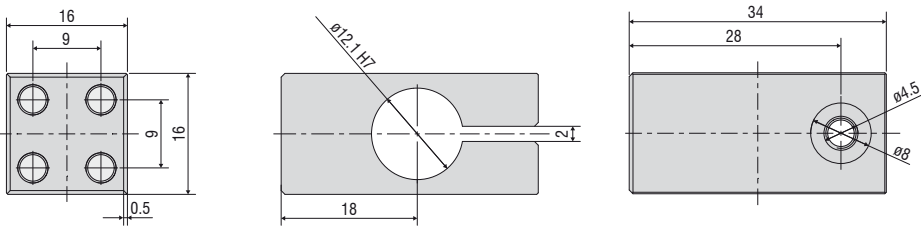

**Accessories: mounting adapter**

MA2400 for sensors IFS2405 / IFS2406 / IFS2407 (consisting of a mounting block and a mounting ring)

Mounting block

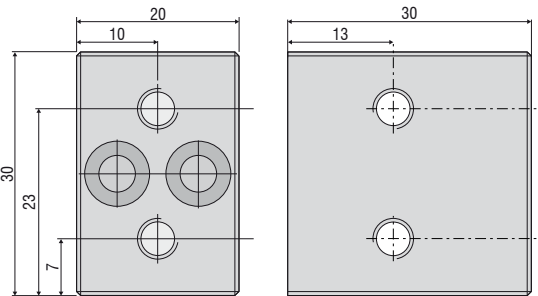

Mounting ring

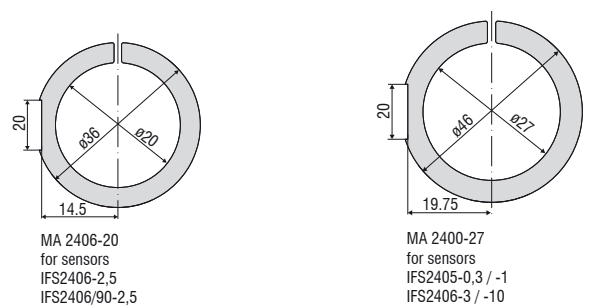

MA 2406-20  
for sensors  
IFS2406-2.5  
IFS2406/90-2,5

MA 2400-27  
for sensors  
IFS2405-0,3 / -1  
IFS2406-3 / -10

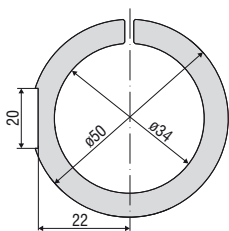

MA 2405-34  
for sensors  
IFS2405-3

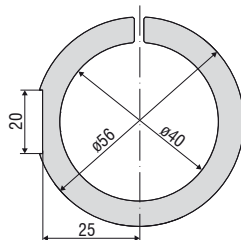

MA 2405-40  
for sensors  
IFS 2405-6

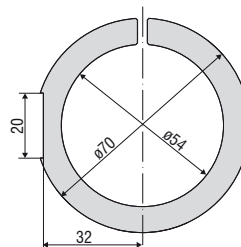

MA 2405-54  
for sensors  
IFS2405-10 / IFS2407-3

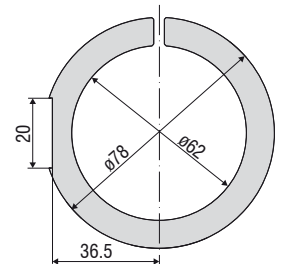

MA 2405-62  
for sensors  
IFS2405-28 / -30

## Accessories

### Software

IFD24xx-Tool Software demo tool included

### Accessories light source

IFL2422/LE Lamp module for IFC2422

IFL24x1/LED Lamp module for IFC24x1

### Cable extension for sensors

CE2402 cable with 2x E2000/APC connectors

CE2402-x Extension for optical fiber (3 m, 10 m, 13 m, 30 m, 50 m)

CE2402-x/PT Extension for optical fiber with protection tube for mechanical stress (3 m, 10 m, customer-specific length up to 50 m)

### Cable for IFS2404 sensors

C2404-x Optical fiber with FC/APC and E2000/APC connectors  
Fiber core diameter 20  $\mu\text{m}$  (2 m)

### Cables for IFS2405/IFS2406/2407-0,1 sensors

C2401 cable with FC/APC and E2000/APC connectors

C2401-x Optical fiber (3 m, 5 m, 10 m, customer-specific length up to 50 m)

C2401/PT-x Optical fiber with protection tube for mechanical stress (3 m, 5 m, 10 m, customer-specific length up to 50 m)

C2401-x (01) Optical fiber core diameter 26  $\mu\text{m}$  (3 m, 5 m, 15 m)

C2401-x(10) Drag-chain suitable optical fiber (3 m, 5 m, 10 m)

C2400 cable with 2x FC/APC connectors

C2400-x Optical fiber (3 m, 5 m, 10 m, customer-specific length up to 50 m)

C2400/PT-x Optical fiber with protection tube for mechanical stress (3 m, 5 m, 10 m, customer-specific length up to 50 m)

C2400/PT-x-Vac Optical fiber with protection tube suitable for use in vacuum (3 m, 5 m, 10 m, customer-specific length up to 50 m)

### Cable for IFS2407/90-0,3 sensors

C2407-x Optical fiber with DIN connector and E2000/APC (2 m, 5 m)

### Vacuum feed through

C2402/Vac/KF16 Vacuum feed through with optical fiber, 1 channel, vacuum side FC/APC non-vacuum side E2000/APC, clamping flange KF 16

C2405/Vac/1/KF16 Vacuum feed through on both sides FC/APC socket, 1 channel, clamping flange type KF 16

C2405/Vac/1/CF16 Vacuum feed through on both sides FC/APC socket, 1 channel, flange type CF 16

C2405/Vac/6/CF63 Vacuum feed through FC/APC socket, 6 channels, flange type CF 63

### Other accessories

SC2471-x/USB/IND Connector cable IFC2461/71, 3 m, 10 m, 20 m

SC2471-x/IF2008 Connector cable IFC2461/71-IF2008, 3 m, 10 m, 20 m

PS2020 Power supply 24V / 2.5A

EC2471-3/OE Encoder cable, 3m

IF2030/PNET Interface module for PROFINET connection

IF2030/ENETIP Interface module for EtherNet/IP connection

### Optical fiber

Temperature range : -50 °C to 90 °C

Bending radius: 30/40 mm

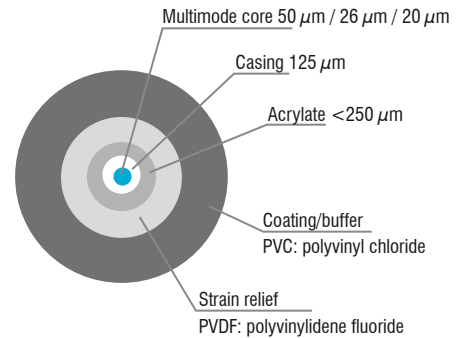

### E2000/APC standard connector

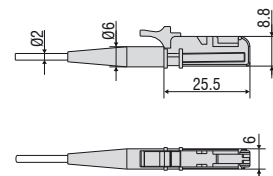

### FC/APC standard connector

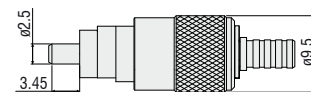

### DIN connector

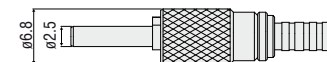

## Sensors and Systems from Micro-Epsilon



Sensors and systems for displacement, distance and position



Sensors and measurement devices for non-contact temperature measurement



Measuring and inspection systems for metal strips, plastics and rubber



Optical micrometers and fiber optics, measuring and test amplifiers



Color recognition sensors, LED analyzers and inline color spectrometers

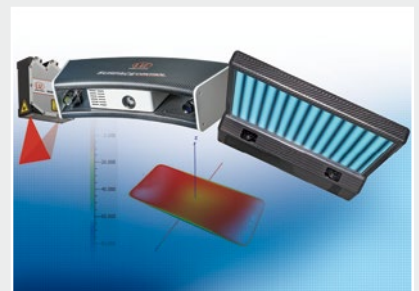

3D measurement technology for dimensional testing and surface inspection