



Instruction Manual optoNCDT 2300

ILD 2300-2

ILD 2300-5

ILD 2300-10

ILD 2300-20

ILD 2300-40

ILD 2300-50

ILD 2300-100

ILD 2300-200

ILD2300-2LL

ILD2300-10LL

ILD2300-20LL

ILD2300-50LL

ILD2300-2BL

ILD2300-5BL

ILD2310-50BL

ILD2300-2DR

ILD 2310-10

ILD 2310-20

ILD 2310-50

MICRO-EPSILON
MESSTECHNIK
GmbH & Co. KG
Königbacher Strasse 15

94496 Ortenburg / Germany

Tel. +49 (0) 8542 / 168-0
Fax +49 (0) 8542 / 168-90
e-mail info@micro-epsilon.de
www.micro-epsilon.com

Certified acc. to DIN EN ISO 9001 : 2008



EtherCAT® is registered trademark and patented technology,
licensed by Beckhoff Automation GmbH, Germany.

Contents

1.	Safety	11
1.1	Symbols Used	11
1.2	Warnings	11
1.3	CE Compliance.....	12
1.4	Proper Use.....	13
1.5	Proper Environment.....	13
2.	Laser Class	14
3.	Functional Principle, Technical Data	17
3.1	Short Description	17
3.2	Real Time Control (A-RTSC).....	18
3.3	Exposure Control.....	18
3.4	Technical Data	19
3.5	Indicator Elements at Sensor	26
4.	Delivery	27
4.1	Unpacking.....	27
4.2	Storage	27
5.	Installation	28
5.1	Diffuse Reflection	30
5.2	Direct Reflection.....	34
5.3	Electrical Connections.....	36
5.3.1	Connection Possibilities	36
5.3.2	Supply Voltage	37
5.3.3	Laser on.....	38
5.3.4	Input and Outputs.....	39
5.3.5	Ethernet	40
5.3.6	EtherCAT.....	41
5.3.7	Connector and Sensor Cable.....	42

6.	Operation	43
6.1	Getting Ready for Operation	43
6.2	Operation via Ethernet.....	43
	6.2.1 Preconditions.....	43
	6.2.2 Access via Ethernet.....	45
	6.2.3 Measurement Presentation via Web Browser.....	46
	6.2.4 Video Signal via Web Browser	48
6.3	Programming via ASCII Commands	49
6.4	Timing, Measurement Value Flux	49
7.	Control Menu, Set Sensor Parameter	51
7.1	Preliminary Remarks to the Adjustments	51
7.2	Overview Parameter.....	51
7.3	Login, Change User Level.....	51
7.4	Default Settings.....	53
	7.4.1 Measurement Program.....	53
	7.4.2 Measuring Rate	53
	7.4.3 Baud Rate for RS422.....	54
	7.4.4 Averaging, Error Processing, Spike Correction and Statistics	57
	7.4.4.1 Measurement Averaging	58
	7.4.4.2 Spike Correction	60
	7.4.4.3 Statistical values.....	62
	7.4.5 Setting Zero and Masters	63
	7.4.6 Material Data Base	64
7.5	Data Output.....	65
	7.5.1 Digital Interfaces.....	65
	7.5.2 Output Data Rate.....	66
7.6	Measurement Control.....	66
	7.6.1 Triggering.....	66
	7.6.1.1 Signal Processing without Trigger	69
	7.6.1.2 Signal Processing - Value Output Trigger	70
	7.6.1.3 Signal Processing - Trigger for Acquiring Values	71
	7.6.1.4 Signal Processing - Trigger for Outputting all Values.....	72

	7.6.2	Trigger Counter.....	74
	7.6.2.1	General.....	74
	7.6.2.2	Trigger ID (T).....	74
	7.6.2.3	Trigger Event Counter.....	74
	7.6.2.4	Trigger Measurement Value Counter.....	75
	7.6.2.5	Example.....	75
	7.6.2.6	Function.....	76
	7.6.2.7	Presets for Trigger Mode and Trigger Edge.....	77
	7.6.3	Synchronization.....	78
7.7		Loading, Saving, Extras.....	80
	7.7.1	Loading/Saving Settings.....	80
	7.7.2	Extras.....	81
8.		Digital Interfaces.....	82
8.1		Preliminary Remarks.....	82
8.2		Ethernet.....	82
	8.2.1	Default Settings.....	82
	8.2.2	Data Format Output Values, Measurement Value Frame Ethernet.....	83
	8.2.3	Measurement Data Transmission to a Measurement Value Server, Measurement Value Block.....	87
	8.2.4	Ethernet Video Signal Transmission.....	89
8.3		RS422.....	89
8.4		EtherCAT.....	91
8.5		Change Ethernet to EtherCAT.....	91
9.		Value Output.....	92
9.1		RS422.....	92
	9.1.1	Possible Output Values and Output Sequence (RS422).....	94
	9.1.2	Error Codes.....	95
9.2		Ethernet.....	96
9.3		EtherCAT.....	96
9.4		Analog Output.....	97
9.5		Error Handling.....	97

10.	Instructions for Operating.....	98
10.1	Reflection Factor of the Target Surface	98
10.2	Error Influences	98
10.2.1	Light from other Sources	98
10.2.2	Color Differences	99
10.2.3	Surface Roughness	99
10.2.4	Temperature Influences	99
10.2.5	Mechanical Vibration	99
10.2.6	Movement Blurs	99
10.2.7	Angle Influences	100
10.3	Optimizing the Measuring Accuracy	101
10.4	Cleaning.....	102
10.5	Protective Housing	103
10.5.1	Versions.....	103
10.5.2	Guidelines	103
10.5.3	Delivery	103
11.	RS422 Connection with USB Converter.....	106
12.	Software Support with MEDAQLib	106
13.	Warranty.....	107
14.	Decommissioning, Disposal	107
15.	Service, Repair	108
Appendix		
A 1	Optional Accessories.....	109
A 2	Factory Setting.....	113
A 2.1	Parameters.....	113
A 2.2	Set Default Settings	114
A 3	PC2300-0.5/Y.....	115
A 4	PC2300-x/OE	116
A 5	IF2004/USB.....	117

A 6	ASCII Communication with Sensor	118
A 6.1	General	118
A 6.2	Commands Overview	120
A 6.3	General Commands	124
A 6.3.1	General	124
A 6.3.1.1	Help	124
A 6.3.1.2	Sensor Information	124
A 6.3.1.3	Synchronization	125
A 6.3.1.4	Booting the Sensor	125
A 6.3.1.5	Reset Counter	126
A 6.3.1.6	Switching the Command Reply, ASCII Interface	126
A 6.3.1.7	PRINT	127
A 6.3.2	User Level.....	128
A 6.3.2.1	Change of the User Level.....	128
A 6.3.2.2	Change to User in the User Level.....	128
A 6.3.2.3	User Level Request.....	128
A 6.3.2.4	Set Standard User.....	128
A 6.3.2.5	Change Password.....	128
A 6.3.3	Triggering.....	129
A 6.3.3.1	Trigger Selection	129
A 6.3.3.2	Effect of the Trigger Input.....	129
A 6.3.3.3	Trigger Level	129
A 6.3.3.4	Number of Measurement Values Displayed	130
A 6.3.3.5	Software Trigger Pulse.....	130
A 6.3.3.6	Trigger Output all Values.....	130
A 6.3.4	Interfaces	131
A 6.3.4.1	Ethernet.....	131
A 6.3.4.2	Setting Measurement Server	131
A 6.3.4.3	Setting RS422	131
A 6.3.4.4	Change between Ethernet / EtherCAT.....	132
A 6.3.4.5	Units Web-Interface.....	132
A 6.3.5	Load / Save Settings	132
A 6.3.5.1	Save Parameter	132
A 6.3.5.2	Load Parameter	132
A 6.3.5.3	Default Settings	132

A 6.4	Measurement.....	133
A 6.4.1	General.....	133
	A 6.4.1.1 Measurement Mode	133
	A 6.4.1.2 Selection of Peak for Displacement Measurement.....	133
	A 6.4.1.3 Video Signal Request.....	133
	A 6.4.1.4 Measuring Rate	133
	A 6.4.1.5 Laser Power.....	134
A 6.4.2	Video Signal	134
	A 6.4.2.1 Reduction of Region of Interest (ROI).....	134
	A 6.4.2.2 Video Averaging	134
A 6.4.3	Material Data Base	135
	A 6.4.3.1 Reading of Material Data Base	135
	A 6.4.3.2 Choose Material	135
	A 6.4.3.3 Display Material	135
	A 6.4.3.4 Edit Material Table.....	136
	A 6.4.3.5 Delete Material Table.....	136
A 6.4.4	Measurement Value Processing.....	136
	A 6.4.4.1 Averaging of Measurement Value.....	136
	A 6.4.4.2 Spike Correction	136
	A 6.4.4.3 Values used for Statistics	137
	A 6.4.4.4 Reset the Statistics.....	137
	A 6.4.4.5 Setting Masters / Zero.....	137
A 6.5	Data Output.....	138
A 6.5.1	General.....	138
	A 6.5.1.1 Selection Digital Output	138
	A 6.5.1.2 Output Data Rate.....	138
	A 6.5.1.3 Error Processing	138
	A 6.5.1.4 Specified Measured Value Output	138
A 6.5.2	Select Measurement Values to be Output	139
	A 6.5.2.1 Request Data Selection.....	139
	A 6.5.2.2 Data Selection Displacement Measurement	139
	A 6.5.2.3 Data Selection Thickness Measurement	139
	A 6.5.2.4 Data Selection Statistic Values.....	140
	A 6.5.2.5 Data Selection Optional Values	140
	A 6.5.2.6 Set Video Output.....	140
A 6.6	Example Command Sequence During Measurement Selection.....	141
A 6.7	Error Messages.....	142

A 7	EtherCAT	146
A 7.1	Generall.....	146
A 7.2	Preamble.....	146
	A 7.2.1 Structure of EtherCAT®-Frames	146
	A 7.2.2 EtherCAT® Services.....	147
	A 7.2.3 Addressing and FMMUs.....	148
	A 7.2.4 Sync Manager	148
	A 7.2.5 EtherCAT State Machine	149
	A 7.2.6 CANopen over EtherCAT.....	149
	A 7.2.7 Process Data PDO Mapping	150
	A 7.2.8 Service Data SDO Service.....	151
A 7.3	CoE – Object Directory.....	152
	A 7.3.1 Characteristics.....	152
	A 7.3.2 Communication Specific Standard Objects (CiA DS-301)	152
	A 7.3.2.1 Object 1000h: Device type.....	153
	A 7.3.2.2 Object 1001h: Error register.....	153
	A 7.3.2.3 Object 1003h: Predefined error field.....	153
	A 7.3.2.4 Object 1008h: Manufacturer device name	153
	A 7.3.2.5 Object 1009h: Hardware version	153
	A 7.3.2.6 Object 100Ah: Software version	154
	A 7.3.2.7 Object 1018h: Device identification	154
	A 7.3.2.8 Object 1A00h: TxPDO Mapping.....	154
	A 7.3.2.9 Object 1A01 up to 1A63: TxPDO mapping.....	155
	A 7.3.2.10 Object 1C00h: Synchronous manager type.....	155
	A 7.3.2.11 Object 1C13h: TxPDO assign	155
	A 7.3.2.12 Object 1C33h: Synchronous parameter.....	156
	A 7.3.3 Manufacturer Specific Objects	157
	A 7.3.3.1 Object 2001h: User level.....	158
	A 7.3.3.2 Object 2005h: Sensor informations (further)	158
	A 7.3.3.3 Object 2010h: Loading/saving settings	159
	A 7.3.3.4 Object 2050h: Advanced settings.....	159
	A 7.3.3.5 Object 2101h: Reset.....	159
	A 7.3.3.6 Object 2105h: Factory settings	160
	A 7.3.3.7 Object 2131h: Light source.....	160
	A 7.3.3.8 Object 2154h: Measuring program.....	160
	A 7.3.3.9 Object 2161h: Peak selection at distance measuring	160
	A 7.3.3.10 Object 2181h: Averaging, error processing, statistics and spike correction	161
	A 7.3.3.11 Object 21B0h: Digital interfaces, selection of transmitted data (measurements)....	163
	A 7.3.3.12 Object 21C0h: Ethernet.....	164

	A 7.3.3.13 Object 21E0h: Zeroing/Mastering	165
	A 7.3.3.14 Object 2250h: Measuring rate	165
	A 7.3.3.15 Object 2410h: Triggermodi	166
	A 7.3.3.16 Object 2711h: Reduction of region of interest.....	167
	A 7.3.3.17 Object 2800h: Material info	167
	A 7.3.3.18 Object 2801h: Material select	168
	A 7.3.3.19 Object 2802h: Material table edit.....	168
	A 7.3.3.20 Object 603Fh: Sensor - error	169
	A 7.3.3.21 Object 6065h: Measurement values	169
A 7.4	Error Codes for SDO Services.....	169
A 7.5	Measurement Data Formats	171
A 7.6	ILD2300 with Oversampling in EtherCAT	171
A 7.7	ILD2300 Distributed Clock.....	179
	A 7.7.1 Synchronization.....	179
	A 7.7.1.1 Synchronization off	180
	A 7.7.1.2 Slave.....	180
	A 7.7.1.3 Slave Alternating	180
	A 7.7.1.4 Apply Selected Settings	180
	A 7.7.1.5 Setting Regardless of TwinCat.....	180
	A 7.7.1.6 Error Message.....	180
A 7.8	Measuring Rates and Measurement Values with EtherCAT	181
A 7.9	Meaning of EtherCAT-STATUS-LED	181
A 7.10	EtherCAT Configuration with the Beckhoff TwinCAT®-Manager.....	182
A 7.11	Finish EtherCAT	188
A 7.12	Troubleshooting.....	189
A 8	Control Menu	193
A 9	Measuring Value Format Ethernet.....	201

1. Safety

The handling of the sensor assumes knowledge of the instruction manual.

1.1 Symbols Used

The following symbols are used in this instruction manual:



Indicates a hazardous situation which, if not avoided, may result in minor or moderate injury.



Indicates a situation which, if not avoided, may lead to property damage.



Indicates a user action.



Indicates a user tip.

Measure

Indicates hardware or a button/menu in the software.

1.2 Warnings

Avoid unnecessary laser radiation to be exposed to the human body.



Switch off the sensor for cleaning and maintenance.



Switch off the sensor for system maintenance and repair if the sensor is integrated into a system.

Caution - use of controls or adjustments or performance of procedures other than those specified may cause harm.



Connect the power supply and the display-/output device in accordance with the safety regulations for electrical equipment.

> Danger of injury

> Damage to or destruction of the sensor

NOTICE

Avoid shock and vibration to the sensor.

> Damage to or destruction of the sensor

Mount the sensor only to the existing holes on a flat surface. Clamps of any kind are not permitted

> Damage to or destruction of the sensor

The power supply may not exceed the specified limits.

> Damage to or destruction of the sensor

Protect the sensor cable against damage.

> Destruction of the sensor

> Failure of the measuring device

Avoid continuous exposure to fluids on the sensor.

> Damage to or destruction of the sensor

Avoid exposure to aggressive materials (washing agent, penetrating liquids or similar) on the sensor.

> Damage to or destruction of the sensor

1.3 CE Compliance

The following applies to the optoNCDT 2300:

- EU directive 2014/30/EU
- EU directive 2011/65/EU, "RoHS" category 9

Products which carry the CE mark satisfy the requirements of the quoted EU directives and the European standards (EN) listed therein. The EC declaration of conformity is kept available according to EC regulation, article 10 by the authorities responsible at

MICRO-EPSILON MESSTECHNIK
GmbH & Co. KG
Königbacher Straße 15
94496 Ortenburg / Germany

The measuring system is designed for use in industry and satisfies the requirements.

1.4 Proper Use

- The optoNCDT 2300 system is designed for use in industrial and laboratory areas.
- It is used
 - for measuring displacement, distance, position and elongation
 - for in-process quality control and dimensional testing
- The sensor may only be operated within the limits specified in the technical data, see Chap. 3.4.
- Use the sensor in such a way that in case of malfunctions or failure personnel or machinery are not endangered.
- Take additional precautions for safety and damage prevention for safety-related applications.

1.5 Proper Environment

- Protection class: IP 65 (applies only when the sensor cable is plugged in)

Lenses are excluded from protection class. Contamination of the lenses leads to impairment or failure of the function.

- Operating temperature: 0 °C ... 50 °C (+32 up to +104 °F)
- Storage temperature: -20 °C ... 70 °C (-4 up to +158 °F)
- Humidity: 5 - 95 % (no condensation)
- Ambient pressure: Atmospheric pressure

• The protection class is limited to water, no penetrating liquids or similar!

2. Laser Class

The optoNCDT 2300 sensors operate with a semiconductor laser with a wavelength of 670 nm (visible/red ILD 2300-x) resp. 405 nm (visible/blue ILD 2300-xBL). The sensors fall within Laser Class 2 (II). The laser is operated on a pulsed mode, the average power is ≤ 1 mW in each case, the peak power can be up to 1.2 mW. The pulse frequency depends on the adjusted measuring rate /1.5 ... 49.140 kHz). The pulse duration of the peaks is regulated depending on the measuring rate and reflectivity of the target and can be 0.5 up to 542 μ s.

i Comply with all regulations on lasers!

CAUTION

Never deliberately look into the laser beam!
Consciously close your eyes or turn away immediately if ever the laser beam should hit your eyes.

Although the laser output is low looking directly into the laser beam must be avoided. Due to the visible light beam eye protection is ensured by the natural blink reflex. The housing of the optical sensors may only be opened by the manufacturer, see Chap. 13. For repair and service purposes the sensors must always be sent to the manufacturer.

The following warning labels are attached to the cover (front and/or rear side) of the sensor housing. The laser warning labels for Germany have already been applied (see above). Those for other non German-speaking countries an IEC standard label is included in delivery and the versions applicable to the user's country must be applied before the equipment is used for the first time. Laser operation is indicated by LED, see Chap. 3.5.



IEC label

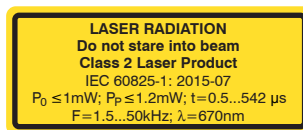

Only for USA

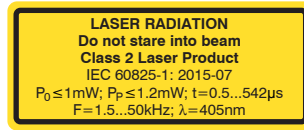

IEC label for ILD2300-x BL

Only for USA

During operation of the sensor the pertinent regulations acc. to IEC 60825-1 on „radiation safety of laser equipment“ must be fully observed at all times. The sensor complies with all applicable laws for the manufacturer of laser devices.

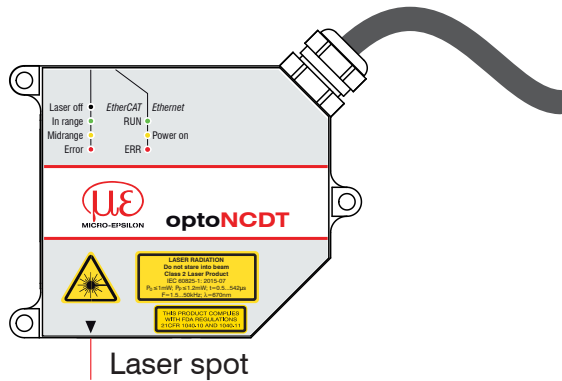

Fig. 1 True reproduction of the sensor with its actual location of the warning labels, ILD 2300

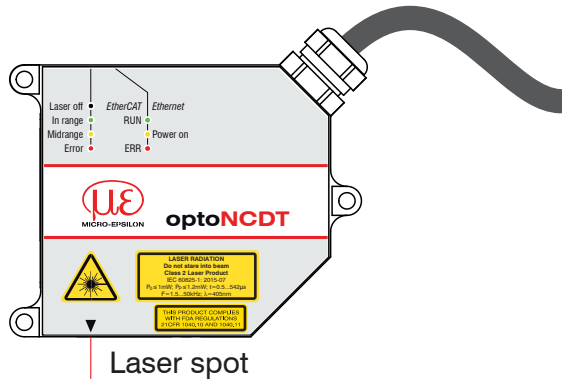

Fig. 2 True reproduction of the sensor with its actual location of the warning labels, ILD2300-x BL

i If both warning labels are covered over when the unit is installed the user must ensure that supplementary labels are applied.

3. Functional Principle, Technical Data

3.1 Short Description

The optoNCDT 2300 operates according to the principle of optical triangulation, i.e. a visible, modulated point of light is projected onto the target surface. With diffuse arrangement, the sensor measures distances while directly arranged the sensor measures distances or the thickness of a transparent measurement object.

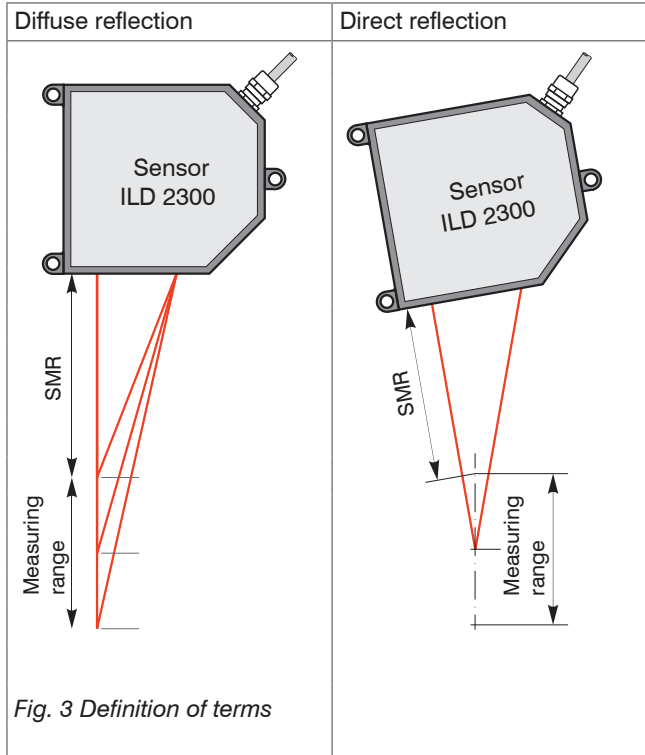

Sensor	Distance	Thickness
ILD 2300-2	•	•
ILD 2300-5	•	•
ILD 2300-10	•	•
ILD 2300-20	•	•
ILD 2300-40	•	
ILD 2300-50	•	
ILD 2300-100	•	
ILD 2300-200	•	
ILD2300-2LL	•	
ILD2300-10LL	•	
ILD2300-20LL	•	
ILD2300-50LL	•	
ILD2300-2BL	•	
ILD2300-5BL	•	
ILD2310-50BL	•	
ILD 2310-10	•	
ILD 2310-20	•	
ILD 2310-50	•	
ILD 2300 2DR	•	•

The diffuse element of the reflection of the light spot is imaged by a receiver optical element positioned at a certain angle to the optical axis of the laser beam onto a high-sensitivity resolution element (CCD), in dependency on displacement. From the output signal of the CCD element a digital signal processor (DSP) in the sensor calculates the displacement between the light spot on the object being measured and the sensor. The displacement is linearized and then issued via digital interfaces.

3.2 Real Time Control (A-RTSC)

The CMOS element determines the intensity of incident light during the exposure. This enables the sensor to compensate for fluctuations in brightness on the object being measured. What is more, it does so in a range from almost total absorption to almost total reflection. The new A-RTSC (Advanced Real-Time-Surface-Compensation) is a development of approved RTSC and allows a more accurate real-time surface compensation in the measurement process with a higher dynamic range.

3.3 Exposure Control

Dark or shining objects to be measured may require a longer exposure time. However, the sensor is not capable of providing exposure which is any longer than permitted by the measurement frequency. For a longer exposure time, therefore, the measurement frequency of the sensor has to be reduced either manually or by command, see Chap. [7.4.2](#).

3.4 Technical Data

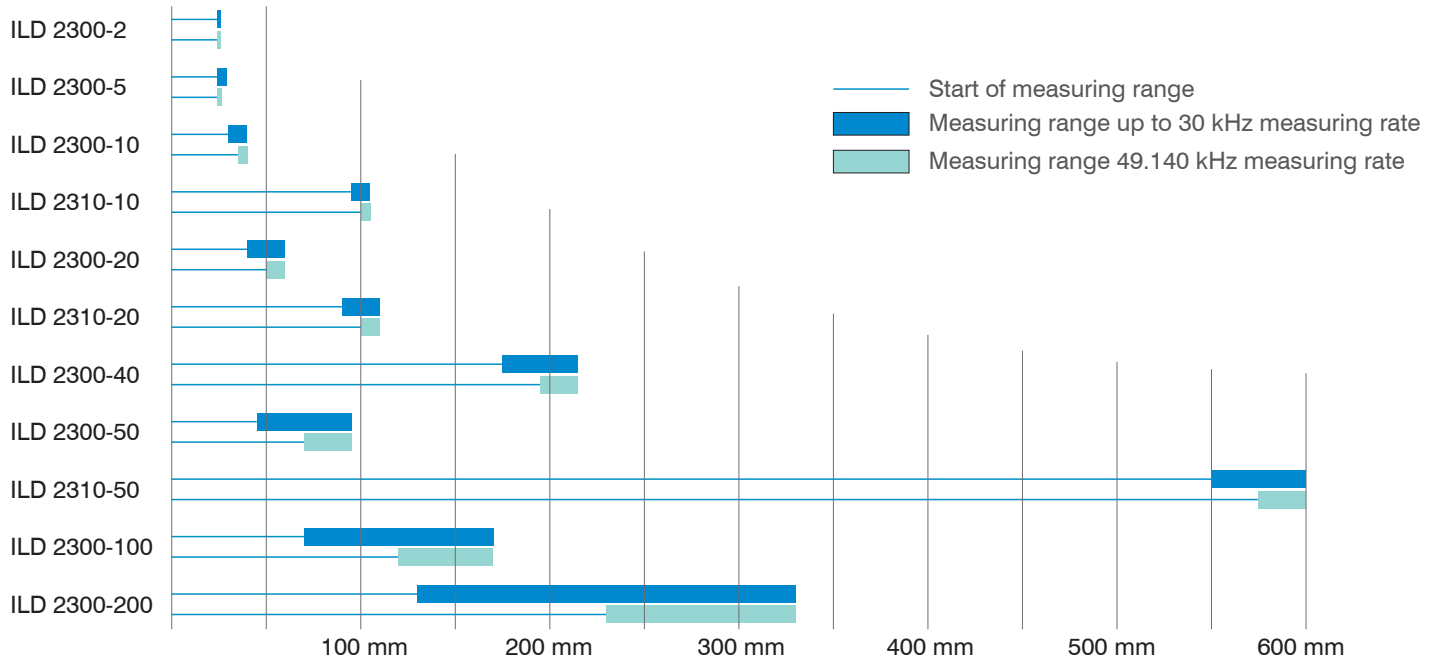

Fig. 4 Measuring ranges for displacement measurement in direct and diffuse reflection

Footnotes to the technical data:

Informations about measuring range, start of measuring range, midrange and end of measuring range depend on the measuring rate.

1) 1. value: Measuring rate of 1.5 kHz up to 30 kHz. 2. value: Measuring rate 49.140 kHz.

2) At a measuring rate of 20 kHz, without averaging.

The specified data apply for a diffusely reflecting matt white ceramic target.

SMR = Start of measuring range; MR = Midrange; EMR = End of measuring range

Type	ILD 2300-	2	5	10	20	30	40	50	100	200
Measuring range ¹	mm	2 / 2 (.08 / .08)	5 / 2 (.20 / .08)	10 / 5 (.39 / .20)	20 / 10 (.79 / .39)	40 / 20 (1.57 / .79)	40 / 20 (1.57 / .79)	50 / 25 (1.97 / .99)	100 / 50 (3.94 / 1.97)	200 / 100 (1.57 / 3.94)
Start of measuring range	mm	24 / 24 (.94 / .94)	24 / 24 (.94 / .94)	30 / 35 (1.18 / 1.38)	40 / 50 (1.57 / 1.97)	175 / 195 (6.89 / 7.68)	175 / 195 (6.89 / 7.68)	45 / 70 (1.77 / 2.76)	70 / 120 (2.76 / 4.72)	130 / 230 (5.12 / 9.06)
Midrange	mm	25 / 25 (.98 / .98)	26.5 / 25 (1.04 / .98)	35 / 37.5 (1.38 / 1.48)	50 / 55 (1.97 / 2.17)	195 / 205 (6.89 / 8.07)	195 / 205 (6.89 / 8.07)	70 / 82.5 (2.76 / 3.25)	120 / 145 (4.72 / 5.71)	230 / 280 (9.06 / 11.02)
End of measuring range	mm	26 / 26 (1.02 / 1.02)	29 / 26 (1.14 / 1.02)	40 / 40 (1.57 / 1.57)	60 / 60 (2.36 / 2.36)	215 / 215 (8.46 / 8.46)	215 / 215 (8.46 / 8.46)	95 / 95 (3.74 / 3.74)	170 / 170 (6.69 / 6.69)	330 / 330 (13.0 / 13.0)
Linearity	μm	0.6	1.5	2	4	12	12	10	30	60
Resolution (at 20 kHz) ²	μm	0.03	0.08	0.15	0.3	0.6	0.6	0.8	1.5	3
Measuring rate, programmable	49.140 / 30 / 20 / 10 / 5 / 2.5 / 1.5 kHz (49.140 kHz with reduced measuring range)									
Light source (Laser diode)	Wave length 670 nm, red, max. power 1 mW, laser class 2									
Permissible ambient light	10,000 lx ... 40,000 lx									
Light spot diameter (±10 %)	SMR, μm	55 x 85	70 x 80	75 x 85	140 x 200	230	230	255 x 350	350	1300
	MR, μm	23 x 23	30 x 30	32 x 45	46 x 45	210	210	70 x 70	130	1300
	EMR, μm	35 x 85	70 x 80	110 x 160	140 x 200	230	230	255 x 350	350	1300
Operating temperature	0 ... +50 °C (+32 °F up to +122 °F)									
Storage temperature	-20 ... +70 °C (-4 °F up to +158 °F)									
Protection class	IP 65 (with plugged connection)									
Power supply U _B	24 VDC (11 ... 30 V); P < 3 W									
Measurement value output	RS422, Ethernet, EtherCAT (selectable)									
Synchronization programmable	Simultaneous or alternating									
Sensor cable (standard)	0.25 m (with cable jack)									
Vibration (acc. to IEC 60068-2-6)	2 g / 20 ... 500 Hz									
Shock (acc. to IEC 60068-2-29)	15 g / 6 ms / 3 axes									
Weight (with 25 cm cable)	550 g					600 g	600 g	550 g		600 g

1) 1. value: Measuring rate of 1.5 kHz up to 30 kHz. 2. value: Measuring rate 49.140 kHz, see Page 17.

Type	ILD 2300-	2LL	10LL	20LL	50LL
Measuring range ¹	mm	2 / 2 (.08 / .08)	10 / 5 (.39 / .20)	20 / 10 (.79 / .39)	50 / 25 (1.97 / .99)
Start of measuring range	mm	24 / 24 (.94 / .94)	30 / 35 (1.18 / 1.38)	40 / 50 (1.57 / 1.97)	45 / 70 (1.77 / 2.76)
Midrange	mm	25 / 25 (.98 / .98)	35 / 37,5 (1.38 / 1.48)	50 / 55 (1.97 / 2.17)	70 / 82.5 (2.76 / 3.25)
End of measuring range	mm	26 / 26 (1.02 / 1.02)	40 / 40 (1.57 / 1.57)	60 / 60 (2.36 / 2.36)	95 / 95 (3.74 / 3.74)
Linearity	μm	0.6	2	4	10
Resolution (at 20 kHz) ²	μm	0.03	0.15	0.3	0.8
Measuring rate, programmable	49.140 / 30 / 20 / 10 / 5 / 2.5 / 1.5 kHz (49.140 kHz with reduced measuring range)				
Light source (Laser diode)	Wave length 670 nm, red, max. power 1 mW, laser class 2				
Permissible ambient light	10,000 lx ... 40,000 lx				
Light spot diameter (±10 %)	SMR, μm	85 x 240	120 x 405	185 x 485	350 x 320
	MR, μm	24 x 280	35 x 585	55 x 700	70 x 960
	EMR, μm	64 x 400	125 x 835	195 x 1200	300 x 1940
Operating temperature	0 ... +50 °C (+32 °F up to +122 °F)				
Storage temperature	-20 ... +70 °C (-4 °F up to +158 °F)				
Protection class	IP 65 (with plugged connection)				
Power supply U _B	24 VDC (11 ... 30 V); P < 3 W				
Measurement value output, selectable	RS422, Ethernet, EtherCAT				
Synchronization programmable	Simultaneous or alternating				
Sensor cable (standard)	0.25 m (with cable jack)				
Vibration (acc. to IEC 60068-2-6)	2 g / 20 ... 500 Hz				
Shock (acc. to IEC 60068-2-29)	15 g / 6 ms / 3 axes				
Weight (with 25 cm cable)	550 g				

1) 1. value: Measuring rate of 1.5 kHz up to 30 kHz. 2. value: Measuring rate 49.140 kHz, see Page 17.

Type	ILD 2310-	10	20	50
Measuring range ¹	mm	10 / 5 (.39 / .20)	20 / 10 (.79 / .39)	50 / 25 (1.97 / .98)
Start of measuring range	mm	95 / 100 (3.74 / 3.94)	90 / 100 (3.54 / 3.94)	550 / 575 (21.7 / 22.6)
Midrange	mm	100 / 102.5 (3.94 / 4.04)	100 / 105 (3.94 / 4.13)	575 / 587.5 (22.6 / 23.1)
End of measuring range	mm	105 / 105 (4.13 / 4.13)	110 / 110 (4.33 / 4.33)	600 / 600 (23.6 / 23.6)
Linearity	μm	3	6	40
Resolution	μm	0,5	1	7.5
Measuring rate, programmable	49.140 / 30 / 20 / 10 / 5 / 2.5 / 1.5 kHz (49.140 kHz with reduced measuring range)			
Light source (Laser diode)	Wave length 670 nm, red, max. power 1 mW, laser class 2			
Permissible ambient light	10,000...40,000 lx			
Spot diameter	SMR	400 x 500	200	400 ... 500
	MMR	400 x 500	60	400 ... 500
	EMR	400 x 500	200	400 ... 500
Operation temperature	0 ... +50°C			
Storage temperature	-20 ... +70°C			
Protection class	IP 65			
Power supply	24 VDC (11 ... 30 V); P < 3 W			
Inputs / Outputs	Ethernet, EtherCAT, RS422			
Inputs	laser on/off; synchronization / trigger input			
Sensor cable	standard: 0.25 m - integrated			
Vibration (Shock)	2g / 20 ... 500Hz (15g / 6ms / 3 axes)			
Weight (with 25 cm cable)	550 g			

1) 1. value: Measuring rate of 1.5 kHz up to 30 kHz. 2. value: Measuring rate 49.140 kHz, see Page 17.

Type	ILD 2300-	2BL	5BL	ILD 2310-50BL
Measuring range ¹	mm	2 / 2 (.08 / .08)	5 / 2 (.20 / .08)	50 / 25 (1.97 / .99)
Start of measuring range	mm	24 / 24 (.94 / .94)	24 / 24 (.94 / .94)	550 / 575 (21.65 / 22.64)
Midrange	mm	25 / 25 (.98 / .98)	26.5 / 25 (1.04 / .98)	575 / 587.5 (22.64 / 23.13)
End of measuring range	mm	26 / 26 (1.02 / 1.02)	29 / 26 (1.14 / 1.02)	600 / 600 (23.62 / 23.62)
Linearity	μm	0.6	1.5	40
Resolution (at 20 kHz)	μm	0.03	0.08	7.5
Measuring rate, programmable	49.140 kHz / 30 / 20 / 10 / 5 / 2.5 / 1.5 kHz (49.140 kHz with reduced measuring range)			
Light source (Laser diode)	Wave length 405 nm, blue, max. power 1 mW, laser class 2			
Permissible ambient light	10.000 lx at 2.5 kHz measuring rate			
Light spot diameter (±10 %)	SMR, μm	70 x 80	200 x 200	400 ... 500
	MR, μm	20 x 20	20 x 20	400 ... 500
	EMR, μm	80 x 100	200 x 400	400 ... 500
Operating temperature	0 ... +50 °C			
Storage temperature	-20 ... +70 °C			
Protection class	IP 65 (with plugged connection)			
Power supply U _B	24 VDC (11 ... 30 V); P < 3 W			
Measurement value output, selectable	RS422, Ethernet, EtherCAT			
Synchronization programmable	Simultaneous or alternating			
Sensor cable (standard)	0.25 m (with cable jack)			
Vibration / Shock	2 g / 20 ... 500 Hz (acc. to IEC 60068-2-6) / 15 g / 6 ms / 3 axes (acc. to IEC 60068-2-29)			
Weight (with 25 cm cable)	550 g		550 g	800 g

1) 1. value: Measuring rate of 1.5 kHz up to 30 kHz. 2. value: Measuring rate 49.140 kHz, see Page 17.

Use of sensor series ILD 2300-xBL in the distance measurement with diffuse and direct reflection.

Model	ILD 2300-	2DR
Measuring range ¹	mm	2
Start of measuring range	mm	9
Midrange	mm	10
End of measuring range	mm	11
Linearity	μm	0.6 (0.03 % FSO)
Resolution (20 kHz)	nm	30 (0.0015 % FSO)
Measuring rate		Switchable per Software 49.140 / 30 / 20 / 10 / 5 / 2.5 / 1.5 kHz (49.057 kHz with reduced measuring range)
Light source (laser diode)		Wave length 405 nm, blue, max. power 1 mW, laser class 2
Permissible ambient light		10,000 ... 40,000 lx
Spot diameter	SMR, μm	21.6 x 25
	MMR, μm	8.5 x 11
	EMR, μm	22.4 x 23.7
Operating temperature		0 ... +50 °C (+32 °F up to +122 °F)
Storage temperature		-20 ... +70 °C (-4 °F up to +158 °F)
Protection class		IP 65
Inputs/Outputs		RS422 / Ethernet / EtherCAT
Inputs		Laser on/off Synch / Trigger
Power supply		24 Vdc (11 ... 30 V); PV < 2 W
Displays	Status LED	off = Laser OFF red = poor target; out of range yellow = SMR green = ok
	Power LED	off = power off green = Ethernet / RS422

Model	ILD 2300-	2DR
Sensor cable	Standard	0.25 m (with connector)
	Option	3 / 10 m with 15-pole sub-D connector
Vibration		2 g / 20 ... 500 Hz
Shock		15 g / 6 ms / 3 axes





FSO = Full Scale Output

SMR = Start of measuring range





MMR = Midrange

EMR = End of measuring range

3.5 Indicator Elements at Sensor

LED	Color		Labeling on sensor	Meaning
EtherCAT		off	RUN	INIT state
		green, flashing 2.5 Hz		PRE-OP state
		green, single flash, 200 ms ON / 1000 ms OFF		SAFE-OP state
		green		OP state
		red, flashing 2.5 Hz	ERR	Invalid configuration
		red, single flash, 200 ms ON / 1000 ms OFF		Not requested state change
		red, double flash, 200 ms ON / 200 ms OFF / 200 ms ON / 400 ms OFF		Timeout watchdog
		red, flashing 10 Hz		Error during initialization
Ethernet		off	Power on	No supply voltage
		yellow		Supply voltage is available

After switching on the sensor both LEDs “EtherCAT/Ethernet” and “Status” are activated.

LED	Color		Labeling on sensor	Meaning
State ¹		off	Laser off	Laser beam is switched off
		green	In range	Sensor in operation
		yellow	Midrange	Target is in midrange
		red	Error	Target out of range, to low reflection

1) LED display for measuring rates < 49.140 kHz only.

4. Delivery

4.1 Unpacking

- 1 Sensor ILD 2300 with 0.25 m connection cable and cable jack
- 2 Laser warning labels according to IEC norm
- RJ45 short-circuit plug
- 1 CD with program <SensorFinder.exe> and instruction manual

➡ Check the delivery for completeness and shipping damage immediately after unpacking.

➡ In case of damage or missing parts, please contact the manufacturer or supplier immediately.

Optional accessory, packed separately:

- 1 Supply and output cable PC2300-x/SUB-D, cable length $x = 3 \text{ m}$, 6 m or 9 m , with cable plug and 15-pol. SUB-D-jack,
- 1 Connection cable PC2300-0,5/Y with 15-pol. SUB-D-plug, RS422/power supply cable (0.5 m long) and Ethernet cable with cable jack RJ45 (0.5 m long).

See Appendix for further cables, see Chap. [A 1](#)

4.2 Storage

Storage temperature: $-20 \text{ up to } +70 \text{ }^\circ\text{C}$ ($-4 \text{ }^\circ\text{F}$ up to $+158 \text{ }^\circ\text{F}$)

Humidity: $5 - 95 \%$ (no condensation)

5. Installation

The optoNCDT 2300 sensor is an optical system for measurements with micrometer accuracy.

The optoNCDT 2300 can be operated in direct or diffuse reflection.

- **i** Make sure it is handled carefully when installing and operating.

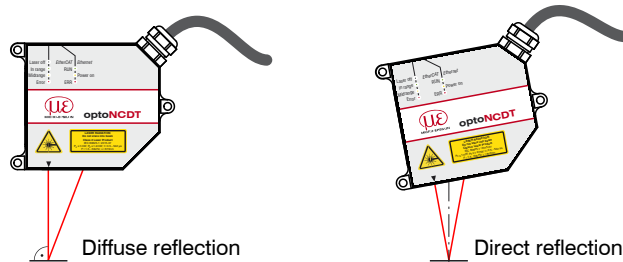

Fig. 5 Distinction sensor assembly in diffuse and direct reflection

- **i** Mount the sensor only to the existing holes on a flat surface. Clamps of any kind are not permitted. Do not exceed torques.

Bolt connection					Direct fastening			
Housing	Through length	Screw	Washer	Tightening torque per screw	Screw depth		Screw	Tightening torque per screw
		ISO 4762-A2	ISO 7089-A2	$\mu = 0.12$	Minimum	Maximum	ISO 4762-A2	$\mu = 0.12$
	mm			Nm	mm	mm		Nm
S	30	M4	A4,3	2	-	-	-	-
S (weight-reduced)	30	M4	A4,3	1.5	-	-	-	-
M	35	M4	A4,3	2	8	10	M5	3.5
L	48	M5	A5,3	3.5	9.6	10	M6	5

Fig. 6 Mounting conditions

Housing sizes, see Chap. 3.4.

Recommended tightening torque \Rightarrow max. + 10 % permissible, not exceeded min. -20 %!

The tightening torques specified in the table are approximate and may vary depending on the application.

Basis of considerations $\mu = 0.12$

The bearing surfaces surrounding the fastening holes (through-holes) are slightly raised.

i Mount the sensor only to the existing holes on a flat surface. Clamps of any kind are not permitted.

To align the sensor, please comply with the “Instructions for Operation“, see Chap. 10.3, especially.

If the sensors are to be used in soiled environments or in higher ambient temperatures than normal, MICRO-EPSILON recommends the use of protective housings, see Chap. 10.5.

The suggested free space in the tuning range, see Fig. 7, is kept clear at least until the end of the measuring range of foreign material and ambient light of other laser sensors.

5.1 Diffuse Reflection

The optoNCDT 2300 sensor is an optical system for measurements with micrometer accuracy.

The laser beam must be directed perpendicularly onto the surface of the target. In case of misalignment it is possible that the measurement results will not always be accurate.

➤ Mount the sensor by means of 3 screwstype M5 (M6) or by means of through bores for M4 (M5) with the screws from the accessories.

MR	SMR	Y
2 (.08)	24 (.94)	1.5 (.06)
5 (.20)	24 (.94)	3.5 (.14)
10 (.39)	30 (1.18)	6.5 (.26)
20 (.79)	40 (1.57)	10.0 (.39)
50 (1.97)	45 (1.77)	23.0 (.91)
100 (3.94)	70 (2.76)	33.5 (1.32)

MR = Measuring range

SMR = Start of measuring range

Millimeter (Inches)

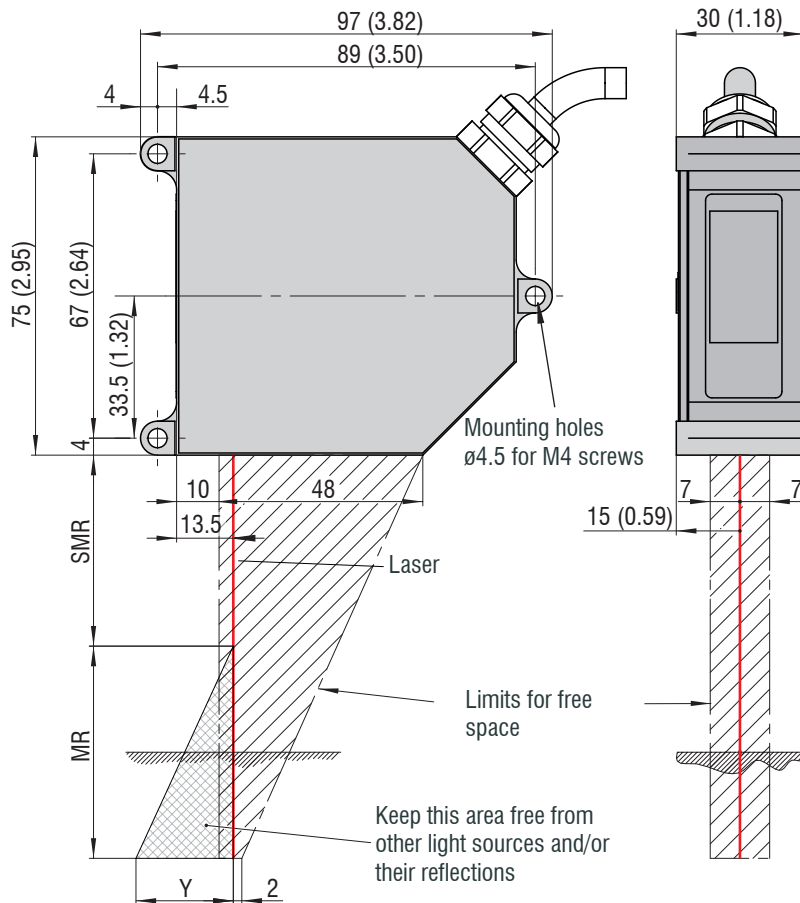

Fig. 7 Dimensional drawing, free space for the measuring ranges 2/5/10/20/50/100 mm

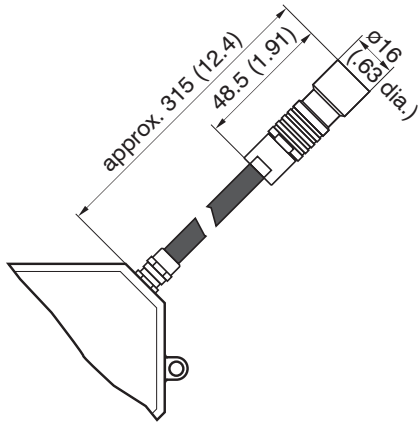

Fig. 8 Dimensional drawing sensor cable

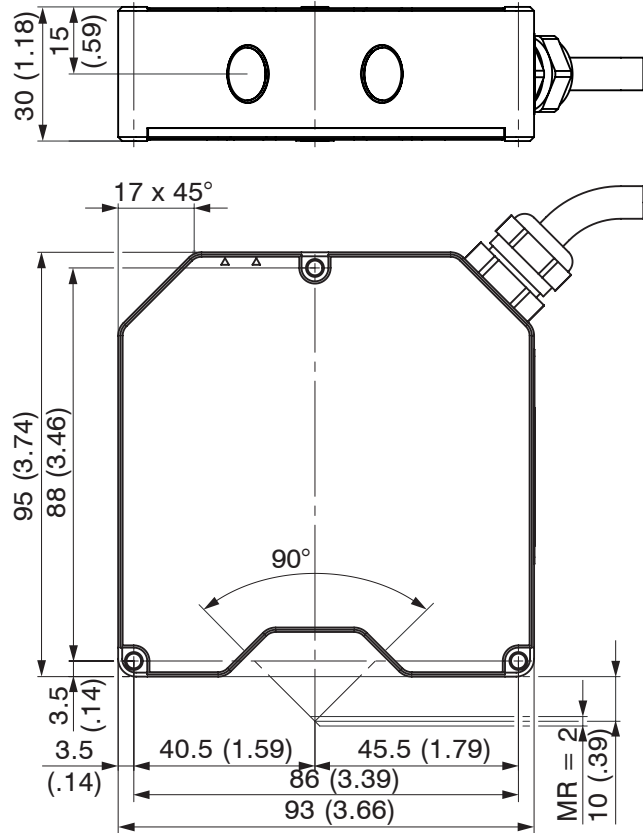
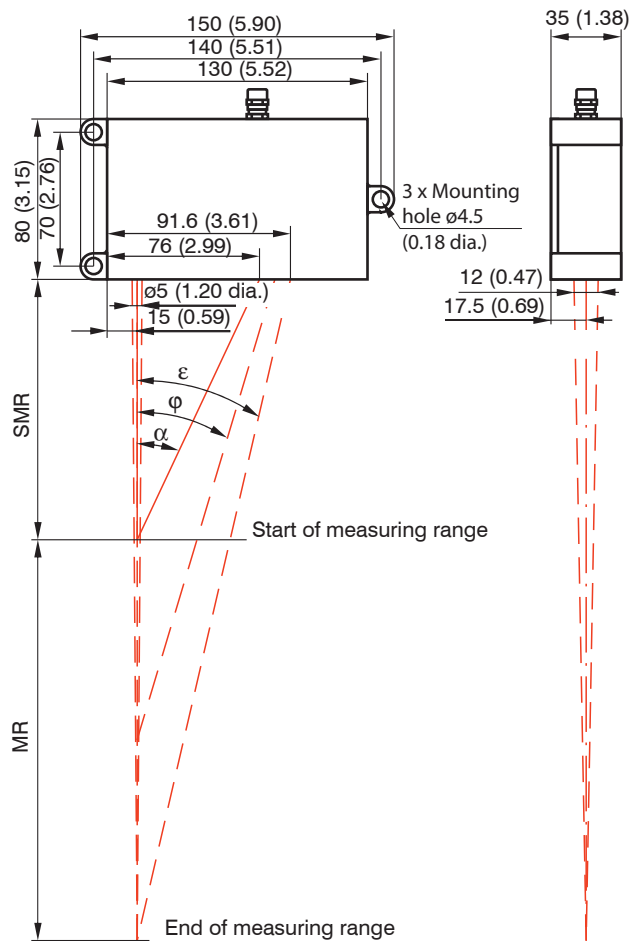

Fig. 9 Dimensional drawing, measuring range 2DR mm



MR	40 (1.57)	200 (7.87)
SMR	175 (6.89)	130 (5.12)
MMR	195 (7.68)	230 (9.06)
EMR	215 (8.46)	330 (12.99)
α	22.1 °	25.1 °
ϕ	21.9 °	16.7 °
ϵ	21.8 °	13.1 °
A	101 (3.98)	91.6 (3.61)
B	86 (3.39)	76.0 (2.99)

MR = Measuring range

SMR = Start of measuring range

MMR = Midrange

EMR = End of measuring range

Millimeter (Inches)

Fig. 10 Dimensional drawing and free space for the measuring range 40/200 mm

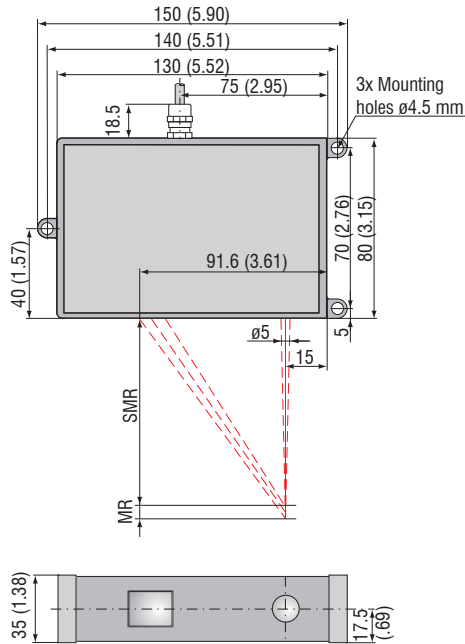

Fig. 11 Dimensional drawing ILD2310, measuring ranges 10/20 mm

MR	10 (.39)	20 (.79)
SMR	95 (3.74)	90 (3.54)
MMR	100 (3.93)	100 (3.94)
EMR	105 (4.13)	110 (4.33)

Millimeter (Inches)

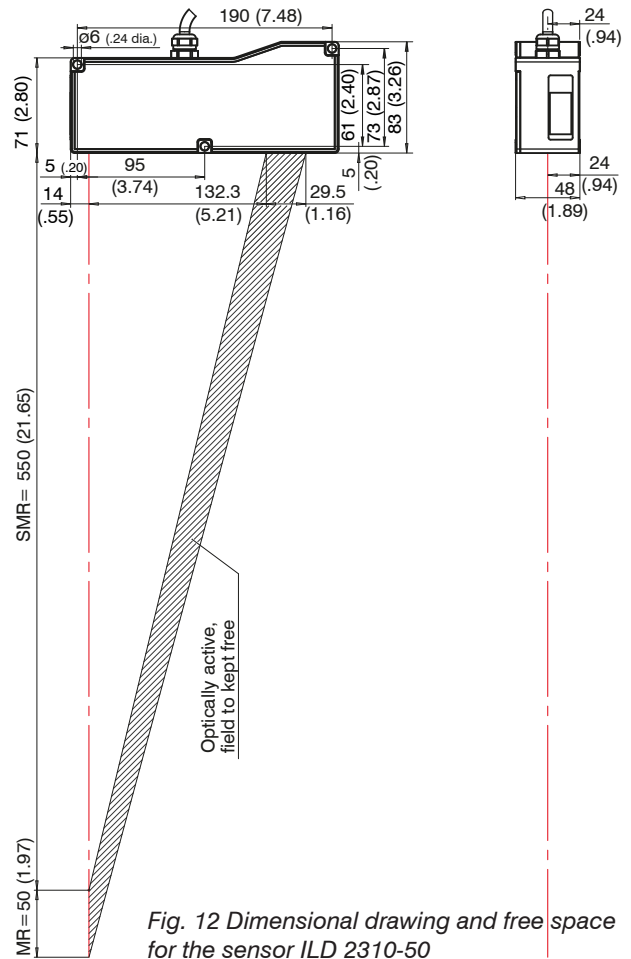

Fig. 12 Dimensional drawing and free space for the sensor ILD 2310-50

5.2 Direct Reflection

The sensor is mounted by means of 3 screws type M4. The bearing surfaces surrounding the fastening holes (through-holes) are slightly raised.

Mount the sensor so, that the reflected laser light hits the receiver element.

MR	SMR + 0.5 MR	alpha
2 (0.08)	25 (0.98)	20.5 °
2DR (0.08)	Drawing, see Fig. 9	
5 (0.20)	26.5 (1.04)	20 °
10 (0.39)	35 (1.38)	17.5 °
20 (0.79)	50 (1.97)	13.8 °

SMR = Start of measuring range

MR = Measuring range

Millimeter (Inches)

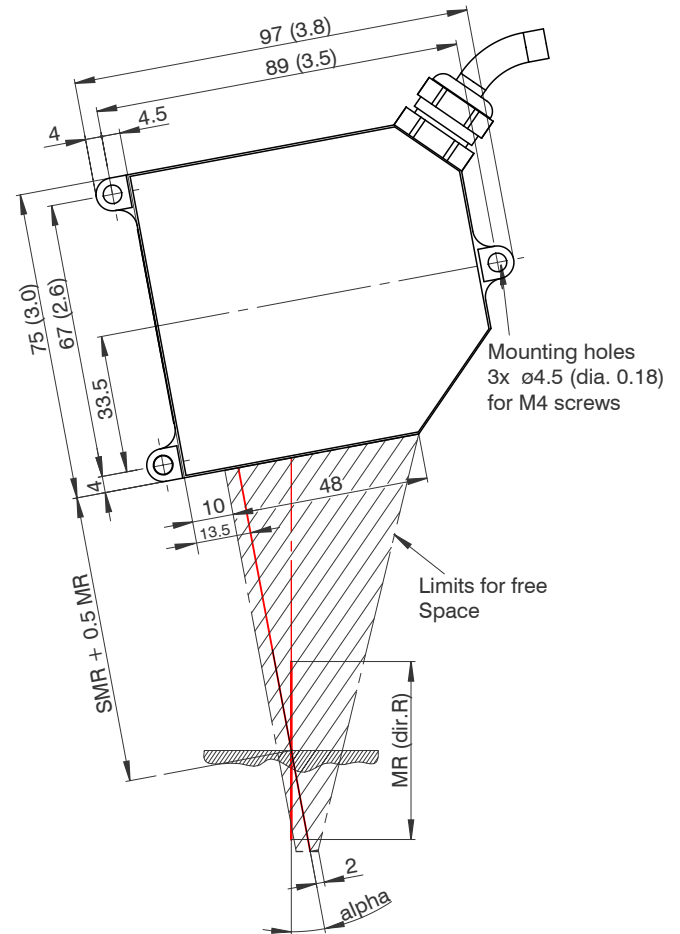
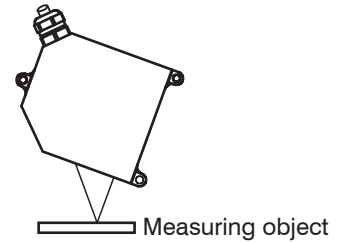

Fig. 13 Dimensional drawing and free space for the measuring ranges 2/5/10/20 mm

Mounting steps:

- Switch on the operating voltage
- Make sure that the “State“ LED on the top side of the sensor.
- Position a shining or mirroring target.



- Move the optional assembly aid between sensor and target.
- The LED “State“ flashes yellow.
- Mount the sensor by means of 3 screws type M4.

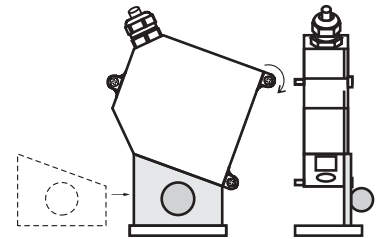

- Remove the fit-up aid between sensor and measuring object.

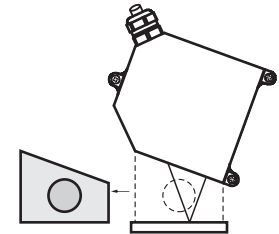

5.3 Electrical Connections

5.3.1 Connection Possibilities

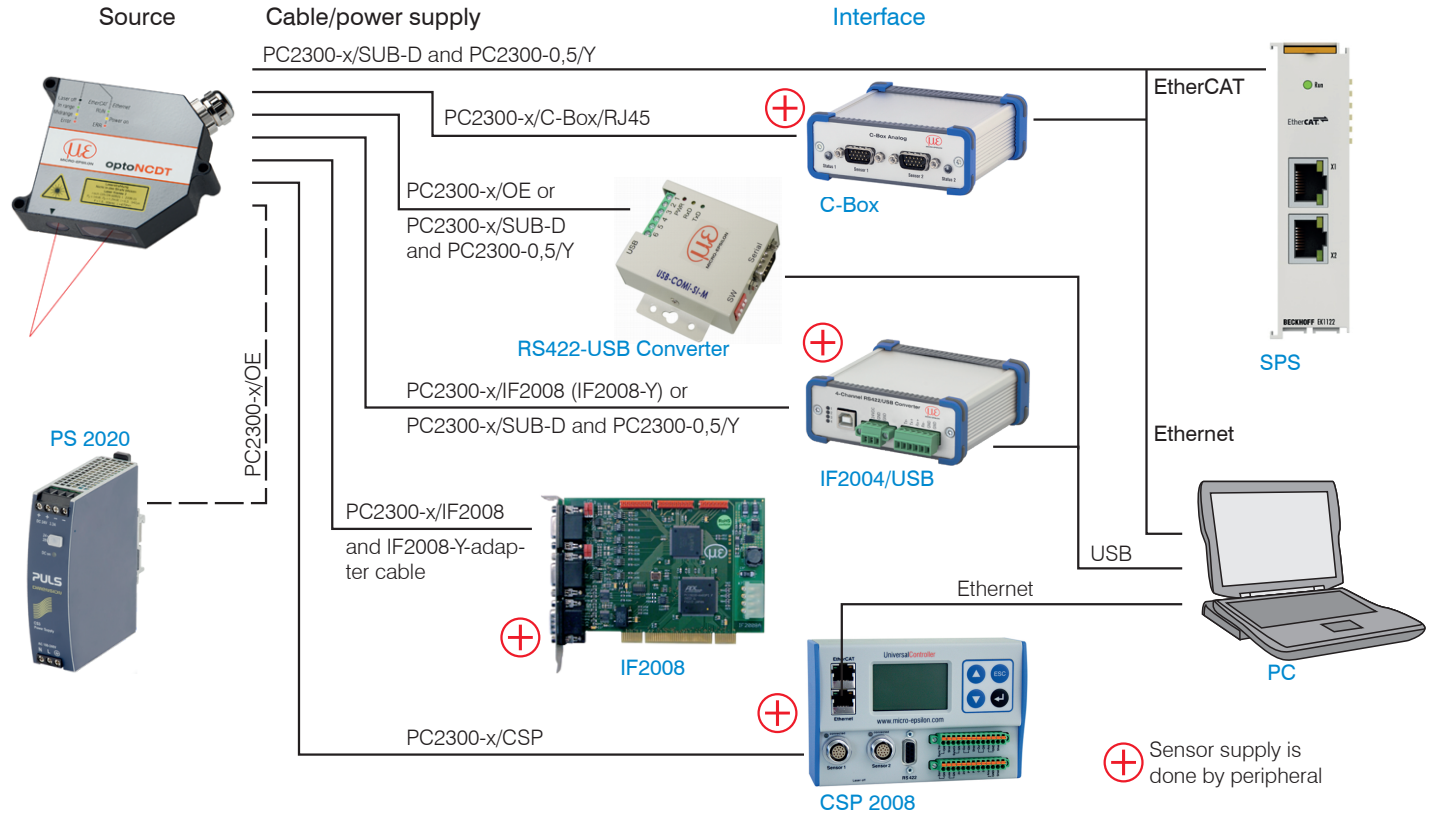

Fig. 14 Connection examples on ILD 2300

The different peripheral devices can be connected by the illustrated connection cables to the 14-pin sensor plug, see Fig. 16. The devices PCI interface card IF2008, 4-way converter IF2004/USB and universal controller CSP2008 also supply the operating voltage (24 V DC) of the sensor via the appropriate connection cable.

Peripheral	Sensor channels	Interface
RS422-USB converter	one	RS422
IF2004/USB	four	
IF2008, PCI interface card	four	
CSP2008, universal controller	two	
Extension terminal CSP2008	two	
Ethernet (network, PC)	any	Ethernet / EtherCAT
EtherCAT (master)	any	
PLC, ILD2300 or the like	---	Synchronization
Switch, button, PLC or the like	---	Switching input laser On/Off

Fig. 15 Max. sensor channels on the peripheral devices

5.3.2 Supply Voltage

Nominal value: 24 V DC (11 ... 30 V, max. 150 mA).

- ➡ Switch on the power supply unit, once wiring is completed.
- ➡ Connect the inputs “1” and “2” at the sensor with a 24 V voltage supply.

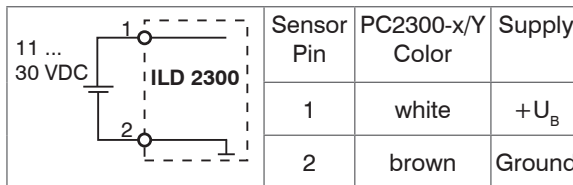

Use the supply voltage for measurement instruments only and not for drive units or similar sources of pulse interference at the same time. MICRO-EPSILON recommends using an optional available power supply unit PS2020 for the sensor.

Fig. 16 Connection of supply voltage

5.3.3 Laser on

The measuring laser on the sensor is activated via an optocoupler input. This is advantageous if the sensor has to be switched off for maintenance or similar. Switching can be done with a transistor (for example open collector in an optocoupler) or a relay contact.

i If pin Pin 3 is not connected with $+U_B$ and Pin 4 is not connected with ground, the laser is off. The wiring for laser on/off with the supply voltage is already done in the PC2300-x/SUB-D and PC2300-0, 5/Y cables.

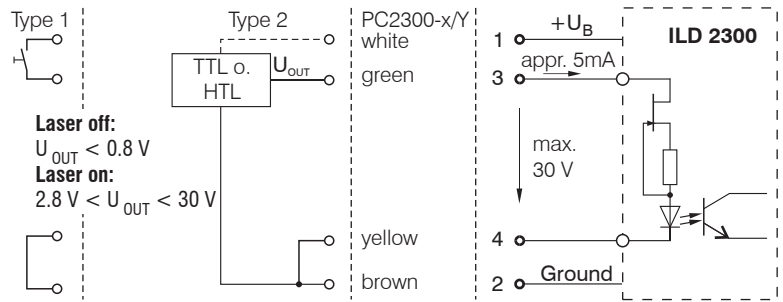

Fig. 17 Electrical wiring for laser off

There is no external resistor for current limiting required. Connect Pin 1 with 3 and Pin 2 with 4 for permanent „Laser on“.

Reaction Time for Laser-On: Correct measuring data are sent by the sensor approximately 1 ms after the laser was switched on.

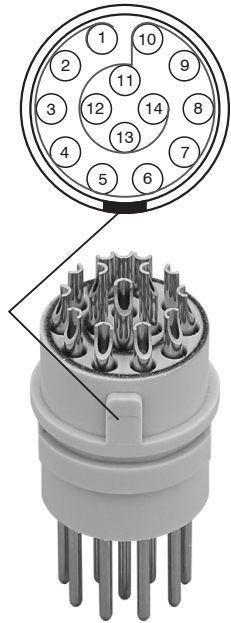

Fig. 18 Sensor round pin plug, view: Solder-pin side male cable connector, insulator

5.3.4 Input and Outputs

Signal Designation	Sensor Pin	Comment	Cable PC2300-x/SUB-D ¹
			15-pol. Sub-D
+ U _b	1	Supply voltage (11 ... 30 VDC)	1
Ground	2	System ground for supply and ground potential for RS422-level	9
+Laser on/off	3	Optocoupler input, potential-free Laser off: U _E ≤ 0,8 V (Low)	2
- Laser on/off	4	Laser on: 2,8 V ≤ U _E ≤ 30 V (High)	10
Sync-in/out ²	5	Synchronous- respectively trigger signals, symmetrically, RS422-Pegel, terminating resistor 120 Ohm switchable, input or output selected depending on the synchronization mode	3
/Sync-in/out ²	6		11
RxD-RS422	7	Serial input RS422, symmetrically,	4
/RxD-RS422	8	Internally terminated with 120 Ohm	12
TxD-RS422	9	Serial output RS422, symmetrically	5
/TxD-RS422	10		13
Tx - Ethernet	11	Ethernet output, potential-free	6
/Tx - Ethernet	12		14
Rx - Ethernet	13	Ethernet input, potential-free	7
/Rx - Ethernet	14		15
Screen	Housing	No galvanic connection to ground	Housing

1) You will find more cables in appendix.

2) In trigger operation, see Chap. 7.6.1, the input is used for triggering.

Plug connector: ODU MINI-SNAP, 14-pol., series B, dimension 2, code F, IP 68.

5.3.5 Ethernet

To connect the sensor via the Ethernet interface the internet protocols TCP and UDP are used. This requires generally a PC with a web browser such as Mozilla Firefox and a free Ethernet interface or a network connection. Standard protocol is TCP/IP.

- ➔ Connect the sensor to a PC via a direct Ethernet connection (LAN) or Switch (Intranet). Therefore use a LAN cable with RJ-45-male connectors and the optionally available cables PC2300-x/SUB-D and PC2300-0.5/Y.

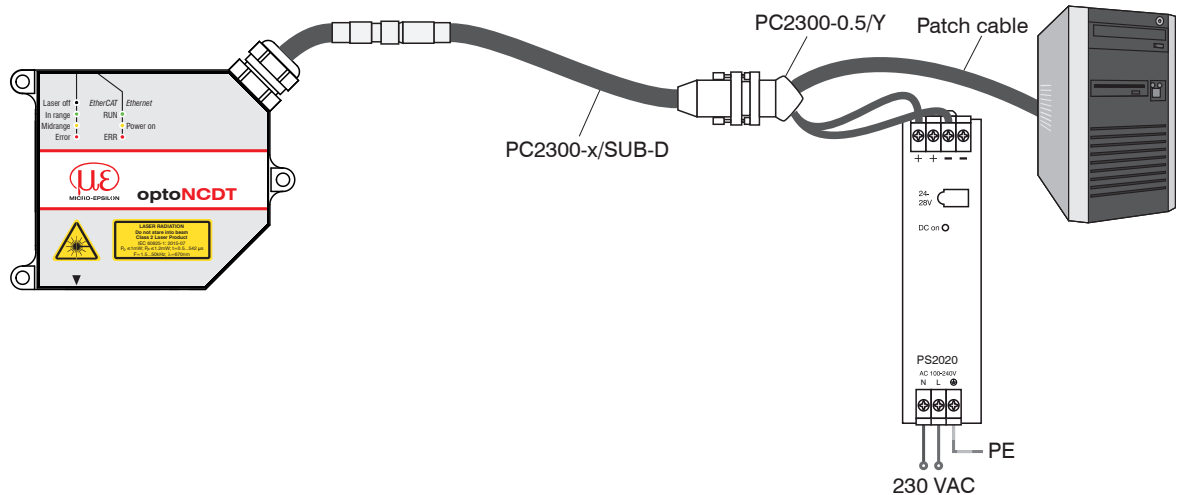

Fig. 19 Measurement setup with Ethernet connection

5.3.6 EtherCAT

Through the Ethernet connection, the sensor can also be integrated into an EtherCAT environment.

- ➔ Connect the sensor to a 2-port EtherCAT junction. Use a LAN cable with RJ-45-male connectors and the optionally available cables PC2300-x/SUB-D and PC2300-0.5/Y.

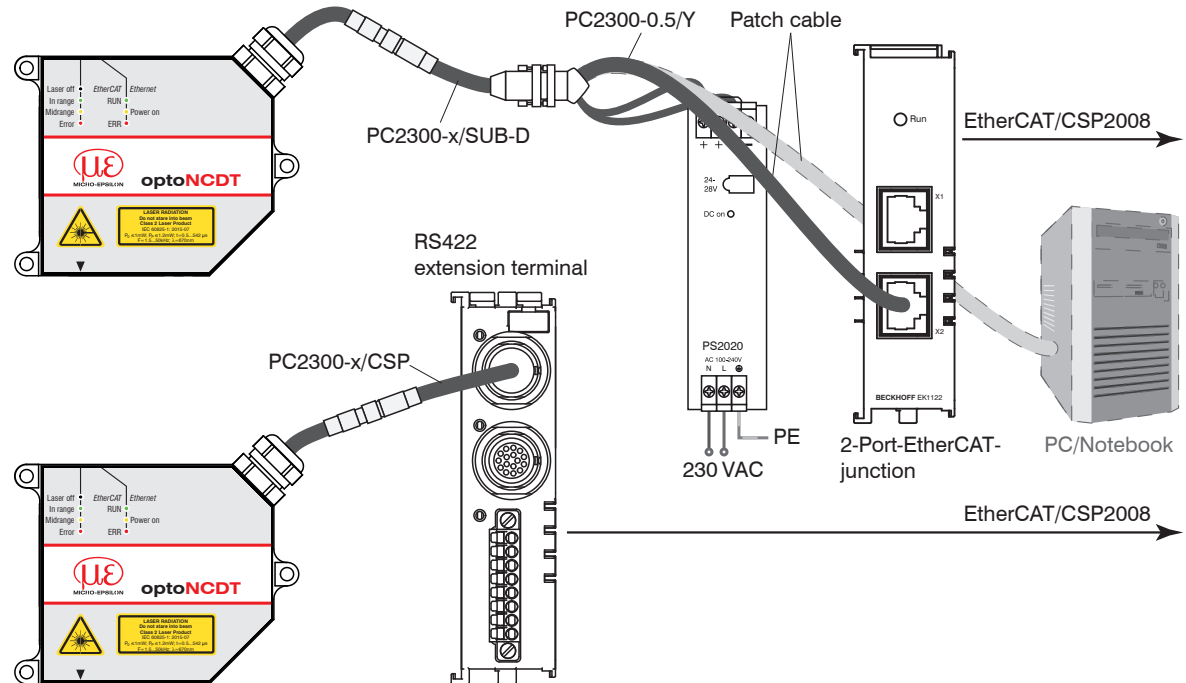

Fig. 20 Measurement setup with EtherCAT connection

Alternatively, a connection via the RS422 extension terminal and the cable PC2300-x/CSP is possible. Both are available as optional accessories. When a sensor ILD2300 is operated together with an Ethernet terminal, so the sensor ILD2300 is also setting to the EtherCAT connection, see Chap. 8.5.

5.3.7 Connector and Sensor Cable

➡ Never bend the sensor cable by more than the bending radius of 90 mm.

The sensor comes with a permanently mounted connection cable of 0.25 m in length. A 3 m, 6 m or 9 m sensor cable has to be attached to the connection cable.

MICRO-EPSILON recommends the use of the standard sensor cable in the appendix, see Chap. A 1, with a chain-type cable capability.

The connector and the cable component are marked with red markings which have to be aligned opposite each other before connection. In addition, they come with guidance grooves to prevent them from being wrongly connected. To release the plug-in connection, hold the plug-in connector on the grooved grips (outer sleeves) and pull apart in a straight line. Pulling on the cable and the lock nut will only lock the plug-in connector (ODU MINI-SNAP FP - lock) and will not release the connection.

➡ Avoid subjecting the cable to excessive pull force. If a cable of over 5 m in length is used and it hangs vertically without being secured, make sure that some form of strain-relief is provided close to the connector.

➡ Never twist the connectors in opposite directions to one another when connected.

➡ Connect the cable shield to the potential equalization (PE, protective earth conductor) on the evaluator (control cabinet, PC housing) and avoid ground loops.

➡ Never lay signal leads next to or together with power cables or pulse-loaded cables (e.g. for drive units and solenoid valves) in a bundle or in cable ducts. Always use separate ducts.

Recommended strand cross-section for self-made connection cables: $\geq 0.14 \text{ mm}^2$ (AWG 25)

i Disconnect or connect the D-sub connection between RS422 and USB converter, when the sensor is disconnected from power supply only.

6. Operation

6.1 Getting Ready for Operation

- Install and assemble the optoNCDT 2300 in accordance with the instructions set out, see Chap. 5.
- Connect the sensor with the indicator or monitoring unit and the power supply.

The laser diode in the sensor can only be activated if at the input „Laser on/off“ Pin 1 is connected to 3 and Pin 2 to 4, see Chap. 5.3.3.

Once the operating voltage has been switched on the sensor runs through an initialization sequence. This is indicated by the momentary activation of all the LEDs. Once initialization has been completed, the sensor transmits a „->“ via the serial interface. The initialization takes up to 10 seconds. Within this period, the sensor neither executes nor replies to commands.

To be able to produce reproducible measurements the sensor typically requires a start-up time of 20 minutes.

If the “state“ LED is not on, this means that

- either there is no operating voltage or
- the laser has been switched off.

6.2 Operation via Ethernet

In the sensor, dynamic Web pages are created that contain the current settings of the sensor and the periphery. The operation is only possible as long as an Ethernet connection to the sensor exists.

6.2.1 Preconditions

You need a web browser (for example Mozilla Firefox or Internet Explorer) on a PC with a network connection. To support a basic first commissioning of the sensor, the sensor is set to a direct connection.

The parallel operation using a web browser and ASCII commands is possible; the last setting applies. Remember to save the settings.

Direct connection to PC, sensor with static IP (Factory setting)		Network
PC with static IP	PC with DHCP	Sensor with dynamic IP, PC with DHCP
<p>➡ Connect the sensor to a PC via a direct Ethernet connection (LAN). Use an optionally available cable PC2300-x and PC2300-0.5/Y.</p>		<p>➡ Connect the sensor to a switch (Intranet). Use an optional available cable PC2300-x und PC2300-0.5/Y.</p>
<p>➡ Now start the SensorFinder.exe program. You will find this program on the provided CD.</p> <p>➡ Click the button <code>Find sensors</code>. Select the designated sensor from the list. In order to change the address settings, click the button <code>Change IP-Address</code>.</p> <ul style="list-style-type: none"> • Address type: static IP address • IP address: 169.254.168.150¹ • Subnet mask: 255.255.0.0 <p>➡ Click the button <code>Change</code>, to transmit the changes to the sensor.</p> <p>➡ Click the button <code>Start browser</code> to connect the sensor with your default browser.</p> <p>1) Requires that the LAN connection on the PC uses, for example, the following IP address: 169.254.168.1.</p>	<p>Wait until Windows has established a network connection (Connection with limited connectivity).</p> <p>➡ Now start the SensorFinder.exe program. You will find this program on the provided CD.</p> <p>➡ Click the button <code>Find sensors</code>. Select the designated sensor from the list.</p> <p>➡ Click the button <code>Start Browser</code> button to connect the sensor with your default browser.</p>	<p>➡ Enter the sensor in the DHCP / register the sensor in your IT department.</p> <p>The sensor gets assigned an IP address from your DHCP server. You can check this IP address with the SensorFinder.exe program.</p> <p>➡ Now start the SensorFinder.exe program. You will find this program on the provided CD.</p> <p>➡ Click the button <code>Find sensors</code>. Select the designated sensor from the list.</p> <p>➡ Click the button <code>Start browser</code>, to connect the sensor with your default browser.</p> <p>Alternatively: If DHCP is enabled and the DHCP server is linked with the DNS server, an access is possible on „ILD2300_SN01234567“ („01234567“ Serial number of your sensor)</p> <p>➡ Start a web browser on your PC. Type „ILD2300_Serial number“ in the address bar of your web browser.</p>

6.2.2 Access via Ethernet

Once the sensor is provided with an IP address, which is valid for your environment and it is known to you, you can connect the sensor with a web browser, see Chap. 6.2.1.

Interactive websites for programming the sensor now appear in the web browser.

The parallel operation using a Web browser and ASCII commands is possible; the last setting applies. Remember to save the settings.

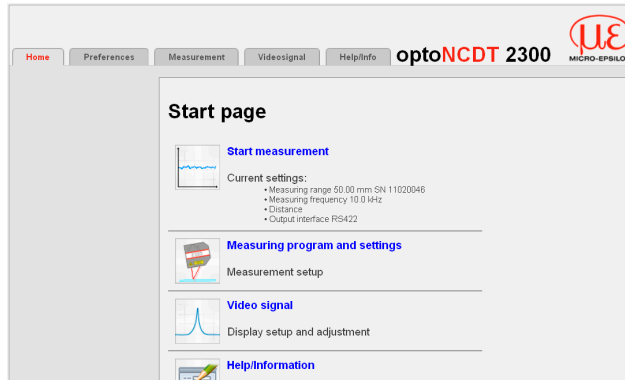

Programming the sensor. In the top navigation bar other auxiliary functions (settings, video signal, etc.) are available. All settings in the website will be immediately executed in the sensor after pressing the button `Apply`.

Fig. 21 First interactive website after selection of the IP address.

The look of the website may change depending on the features. Each page contains descriptions of the parameters and so tips for filling out the web site.

Further sub-menus, such as measuring rate and triggering, are available via the left navigation of the website.

i After programming all the settings are to be stored permanently in a set of parameters. The next time you turn on the sensor they are available again.

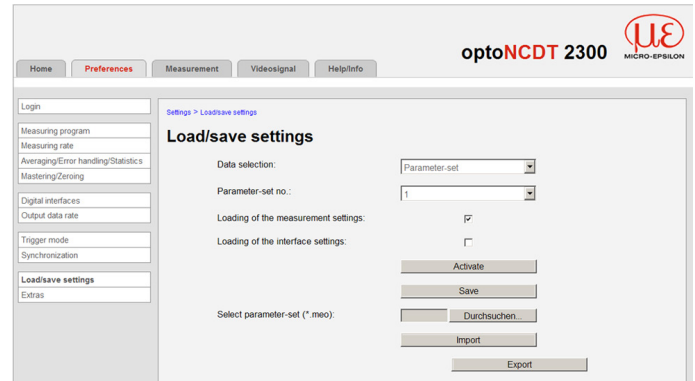

6.2.3 Measurement Presentation via Web Browser

For graphical description of the measuring results “Java” must be enabled and updated in the browser.

➡ Start the measurement value display (Measurement) in the horizontal navigation bar.

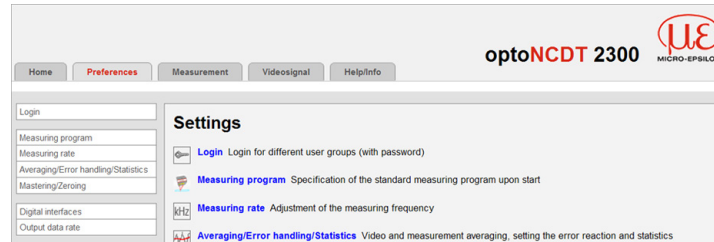

Fig. 22 Web interface

i If you leave the diagram display in a separate tab or window of the browser running, you do not have to restart the description each time.

➡ Click the button *Start*, for starting the display of the measurement results.

The demo can only be started, if a possible saving of measured values is completed via Ethernet, because only one of two features can be active via Ethernet.

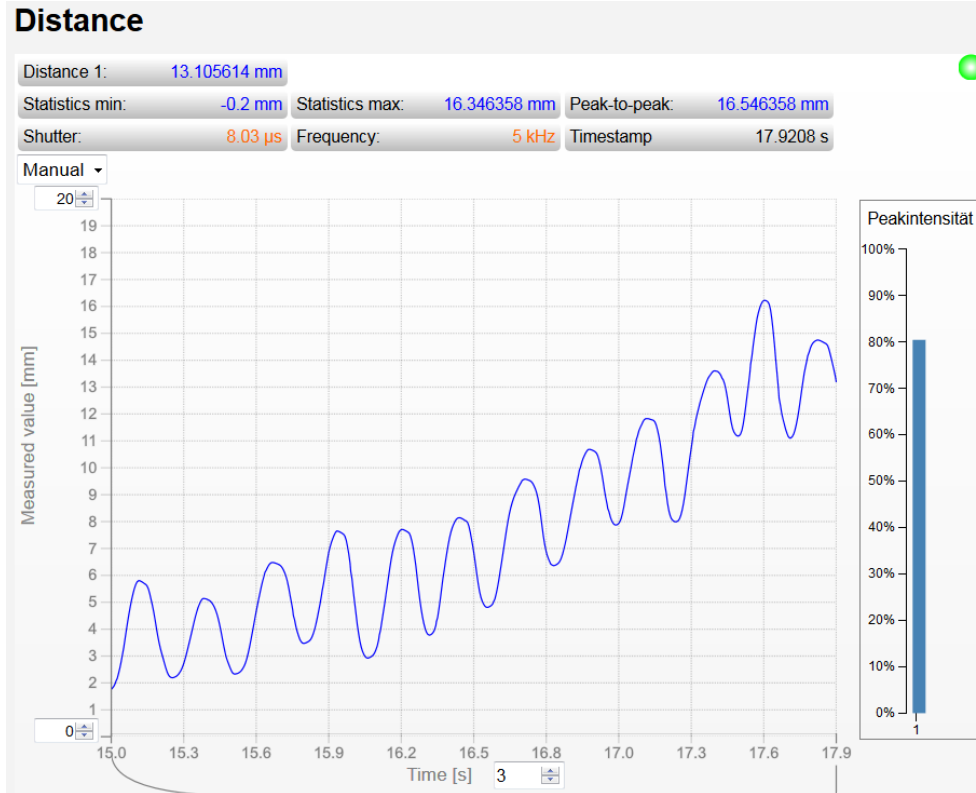

Fig. 23 Display of measurement results

6.2.4 Video Signal via Web Browser

With the presentation of raw and filtered video signals the effects of the adjustable video filter (video averaging) are shown. The raw signal corresponds to the signal of the detector.

The filtered signal is

- independent of the video averaging settings in the settings menu,
- preprocessed through the first signal processing stage.

There is no linear relationship between the position of the peaks in the video signal and the output measurement value.

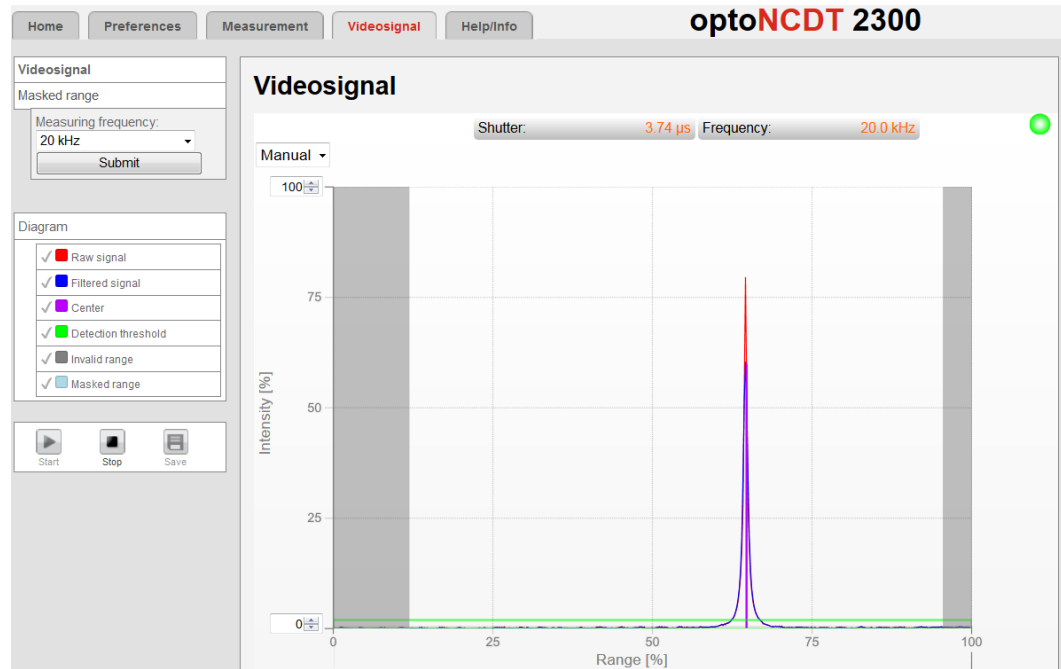

Fig. 24 Display of video signals

6.3 Programming via ASCII Commands

As an added feature you can program the sensor via an ASCII interface, physically RS422 and / or Ethernet. This requires, that the sensor must be connected either to a serial RS422 interface via a suitable interface converter, see Chap. A 1, or a plug-in-card to a PC / PLC. In addition, the Ethernet interface can be used via a suitable program, for example Telnet.

Pay attention in the programs used to the correct RS422 default setting or a valid Ethernet address.

Once connected, you can transfer the commands from the appendix, see Chap. A 6, via the terminal or Telnet to the sensor.

6.4 Timing, Measurement Value Flux

The sensor operates internally with real time cycles in a pipeline mode:

The sensor requires 5 cycles for measuring and processing without triggering.

1. Exposure: Charging the image detector in the receiver (measurement),
2. Reading: Reading out of the imaging device and converting into digital data,
3. Computing (2 cycles),
4. Synchronous output.

Each cycle takes about 20 μs at a measuring rate of 49.140 kHz. The measured value N is available after each cycle with a constant lag of 5 cycles in respect to the real time event. The delay time between detection and start of outputs is therefore 100 μs . The processing of the cycles occurs sequentially in time and parallel in space (pipelining). This guarantees a constant real time data stream. A measured value delayed by 5 cycles is output for each measurement cycle.

Averaging the measured values has no effect on the time behavior. Remember, however, that the sensor needs time for the averaging, until measured values are present according to the set averaging number N. Depending on the nature of the averaging value and the number of averaged values, there are different settling times.

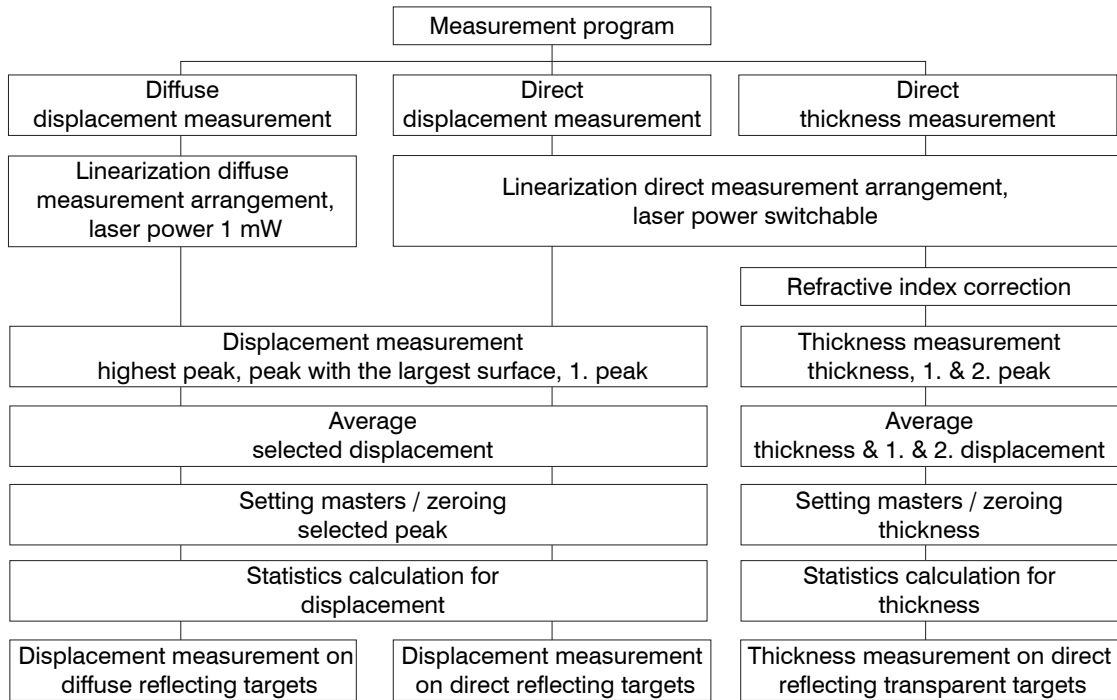

Fig. 25 Adjustment possibilities of the optoNCDT 2300

Grey shaded fields require a selection.

Value fields require you to specify a value.

7. Control Menu, Set Sensor Parameter

7.1 Preliminary Remarks to the Adjustments

You can program the optoNCDT 2300 simultaneously in two different ways:

- using a web browser via the sensor Web interface
- ASCII command set and a terminal program via RS422 or Ethernet (Telnet). Received measurement values are displayed with binary character.

i If you do not save the programming permanently in the sensor, you lost the settings after turning off the sensor.

7.2 Overview Parameter

The following parameters can be set or change in the optoNCDT 2300, see [Fig. 22](#) menu *Settings*.

Login	Entering a password, change user level
Default settings	Measurement program, measurement frequency, averaging, behavior in the case of error, setting zero/setting masters and material data base for thickness measurement
Data output	Selection and setting of digital interface, data to be emitted, under-scanning
Measurement control	Triggering, synchronization of sensors
Parameter, extras	Loading/saving parameter- and interface settings Menu language, factory setting

7.3 Login, Change User Level

The assignment of a password prevents unauthorized changing of settings on the sensor. When delivered, the password protection is not enabled. The sensor operates in the user level "expert". The password protection should be enabled after configuration of the sensor. The default password for the expert level is "000".

i The default password or a user-defined password is not changed by a software update. The expert password is independent of the setup and is therefore not together loaded or saved with the setup.

The following functions are available for the user:

	User	Expert
Password required	no	yes
Looking settings	yes	yes
Changing settings, changing password	no	yes
Measurement value, looking video signal	yes ¹	yes
Scaling diagrams	yes	yes
Setting factory setting	no	yes

Fig. 26 Rights in the user hierarchy

Login

You are currently logged in as **User**.

Password

Type the default password “000” or a user-defined password in the `Password` field and confirm with login.

Change with a click on the `Logout` button in the mode user.

Fig. 27 Change in the expert user level

The user management allows you to assign a custom password in the “expert” mode.

Password	<i>Value</i>	<i>Case-sensitive rules are observed for all passwords. Numbers are allowed. Special characters are not allowed.</i>
User level when switching on	<i>User / Expert</i>	<i>Specifies the user level, with which the sensor starts after the re-starting. For this purpose, MICRO-EPSILON recommends the selection user.</i>

1) Only if there is no measurement output via a different interface. Otherwise you must be logged in expert mode.

7.4 Default Settings

7.4.1 Measurement Program

Settings for the measurement programs in the optoNCDT 2300.

Measurement setup	<i>diffuse reflection / direct reflection / displacement measurement / direct reflection thickness measurement</i>	<i>Displacement measurement by diffuse reflection; sensor evaluates the reflected stray light. Displacement or thickness measurement by direct reflection; Sensor evaluates the light, which is reflected at the target surface. The sensor uses the first both peaks for thickness measurement.</i>
Peak to be measured	<i>first peak / highest peak / widest peak</i>	<i>Defines, which signal is used for the evaluation in the line signal. First Peak: Nearest peak to sensor. Highest peak: Standard, peak with the highest intensity. Widest Peak: Signal with the largest area, use by small adjacent faults</i>

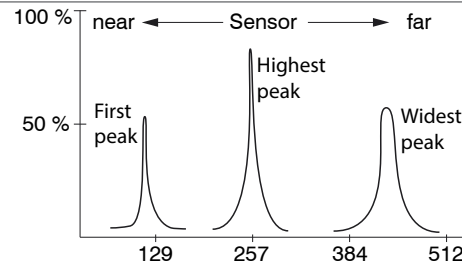
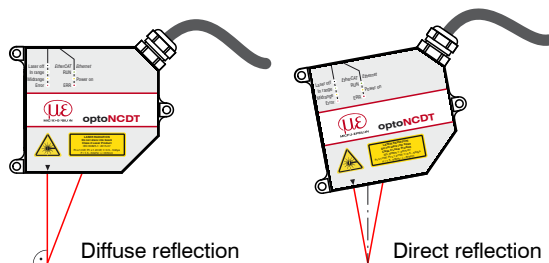

7.4.2 Measuring Rate

Setting for the measuring rate in the optoNCDT 2300 and so the data rate.

Measuring rate	<i>1.5 / 2.5 / 5 / 10 / 20 / 30 / 49.140 kHz</i>	<i>Dark and shining objects may require a slower measuring rate. The control do not expose longer than the measuring rate allows. The measurement range of the sensor is reduced at 49.140 kHz.</i>
----------------	--	---

The measuring rate defines the number of measurements performed by the sensor per second.

Grey shaded fields require a selection.

Dark-bordered fields require you to specify a value.

i Synchronized sensors must always be set to the same measuring rate. Use a high measuring rate for light colored and matt objects to be measured. Use a low measuring rate for dark or shiny objects to be measured (e.g. surfaces covered in black lacquer), for better measurement results.

At a maximum measuring rate of 49.140 kHz the CMOS element is exposed 49.140 times per second.

The lower the measuring rate, the longer the maximum exposure time. The real-time control of the sensor reduces the exposure time in dependency on the amount of light hitting the CMOS element and therefore compensates for reflection changes at the same time, e.g. caused by imprints on the surface of the object being measured.

The output rate gives the actual number of measurement values at the sensor output per second. The maximum output rate can never exceed the measuring rate.

7.4.3 Baud Rate for RS422

To detect a data loss on the receiver side, the sensor sends in this case a runtime error. If not all data can be output via RS422, error codes are issued in the next record.

No trigger, no synchronization set

Calculation of the output rate using the RS422 serial interface:

$$BR > 33 * MR * m / ODR$$

Abbreviations used

BR Baud rate set on sensor and on the other side [kBaud]

MR Measuring rate [kHz]

ODR Output data rate

m Number of values to transfer (measuring value + additionally selected value e.g intensity), see Chap. 9.1.1

The factor 33 means that per value transmitted 3 bytes are transmitted, with real 11 bit are used on the serial line.

Fig. 28 Equation 1, dimensioning of the baud rate without trigger, no synchronization

With synchronization

$$BR > 33 * MR * m / ODR / a$$

Abbreviations used:

BR Baud rate set on sensor and on the other side [kBaud]

MR Measuring rate [kHz]

ODR Output data rate

a Synchronization

a = 1: Synchronization

a = 2: Alternating synchronization (master respectively slave)

m Number of values to transfer (measuring value + additionally selected value e.g intensity), see Chap. [9.1.1](#)

The factor 33 means that per value transmitted 3 bytes are transmitted, with real 11 bit are used on the serial line.

Fig. 29 Equation 1, dimensioning of the baud rate with synchronization

In alternating synchronization the measuring rate is halved and thus a lower baud rate can also be used.

With triggering

To secure the data transmission in the different trigger types, first is to determine the baud rate according to the equation 1, see [Fig. 29](#). If equation 1 is satisfied, then applies for edge or level triggering:

Edge triggering

$$BR > 33 * TF * m * TC / AD$$

Level triggering

$$BR > 33 * TF * m * (Ti/Tp) / AD$$

Fig. 30 Equation 3, dimensioning of the baud rate with trigger

Abbreviations used:

BR Baud rate set on sensor and on the other side [kBaud]

TF Trigger rate [kHz]

m Number of values to transfer (measuring value + additionally selected value e.g intensity), see [Chap. 9.1.1](#)

ODR Output data rate

TC Number of measuring values per trigger edge

Ti Trigger pulse duration

Tp Trigger pulse pause

The factor 33 means that per value transmitted 3 bytes are transmitted, with real 11 bit are used on the serial line.

7.4.4 Averaging, Error Processing, Spike Correction and Statistics

Video averaging	No averaging / Recursive 2 / 4 / 8 Moving 2 / 3 / 4 Median 3			The video averaging is effected before the calculation of the displacement or thickness. Recommended for very small peaks respectively to receive more valid data.
Averaging of measurement value	No averaging			Indication of averaging mode. The averaging number N indicates the number of consecutive measurement values to be averaged in the sensor.
	Moving N values	2 / 4 / 8 ... 128	Value	
	Recursive N values	2 ... 32768	Value	
	Median N values	3 / 5 / 7 / 9	Value	
Error processing	Error output, no measurement value			Sensor emits error value.
	Hold last value	0 ... 1024	Value	If no valid measurement value is determined, the last valid value can be hold for a certain period, that is, output repeatedly. The last valid value is kept indefinitely at „0“.
Spike correction	No			
	Yes	Evaluation length 1 - 10	Value	This filter removes individual very high spikes from a relatively constant course of measurement value.
		Max. tolerance range (mm) 0 - 100	Value	Smaller spikes are preserved.
Number of corrected value 1 - 100		Value		
Statistics	2 / 4 / 8 / 16 ... 16384			Beyond a certain number of measurement values the statistical values minimum, maximum and peak-to-peak are determined and output.

Grey shaded fields require a selection.

Dark-bordered fields require you to specify a value.

An averaging in two different ranges of the signal processing is possible in the optoNCDT 2300.

- Averaging in video signal
- Averaging of measurement values

The averaging is recommended for static measurements or slowly changing values.

In the sensor, one after another following video curves are averaged pixel by pixel. The effect of different settings can be observed in a second curve "Filtered signal" in the web browser in the category `video signal`.

7.4.4.1 Measurement Averaging

The averaging of measurement values is effected after the calculation of the displacement and thickness values prior to the output via the interfaces.

The purpose of averaging is to:

- Improve the resolution
- Eliminate signal spikes or
- „Smooth out“ the signal.

Averaging has no effect on linearity.

In completion of the measuring cycle the internal average is calculated again.

- **I** The preset average value and the number of averaging are to save in the sensor, so that they remain after switching off.

Averaging does not affect the measuring rate or data rates in digital measurement value output. The averaging numbers can also be used if programmed via the digital interfaces. The sensor optoNCDT 2300 is supplied ex factory with the default setting „Median 9“, that is, averaging with Median and 9 measurements.

Moving average

The selected number N of successive measurement values (window width) is used to generate the arithmetic average value M_{gl} on the basis of the following formula:

$$M_{gl} = \frac{\sum_{k=1}^N MV(k)}{N}$$

MV = Measurement value,

N = Averaging number,

k = Running index

M_{gl} = Averaging value respectively output value

Mode:

Each new measurement value is added and the first (oldest) measurement value from the averaging process (from the window) taken out again. This results in short transient recovery times for jumps in measurement values.

Example with N = 4

... 0, 1, 2, 2, 1, 3

$$\frac{2, 2, 1, 3}{4} = M_{gl}(n)$$

... 1, 2, 2, 1, 3, 4

$$\frac{2, 1, 3, 4}{4} = M_{gl}(n+1)$$

Measurement values

Output value

Characteristics:

When moving averaging in the optoNCDT 2300 only powers of 2 for the averaging number N are allowed.

Range of values for number of average N is 1 / 2 / 4 / 8 ... 128.

Recursive Average

Formula:

$$M_{rek}(n) = \frac{MV_{(n)} + (N-1) \times M_{rek}(n-1)}{N}$$

MV = Measurement value,

N = Averaging number,

n = Measurement value index

M_{rek} = Averaging value respectively output value

Mode:

Each new measurement value MV(n) is added, as a weighted value, to the sum of the previous measurement values $M_{rek}(n-1)$.

Characteristics:

The recursive average permits a high degree of smoothing of the measurement values. However, it requires extremely long transient recovery times for steps in measurement values. The recursive average shows low pass behavior. Range of values for number of average N is 1 ... 32768.

Median

The median is generated from a pre-selected number of measurement values.

Mode:

To do so, the incoming measurement values (3, 5, 7 or 9 measurement values) are resorted again after every measurement. The average value is then given as the median. In generating the median in the sensor, 3, 5, 7 or 9 measurement values are taken into account, that is, there is never a median of 1.

Characteristics:

This averaging mode suppresses individual interference pulses. The measurement value curve is not smoothed to a great extent.

Example: Average from five measurement values

... 0 1 2 4 5 1 3 → Sorted measurement values: 1 2 **3** 4 5 Median_(n) = 3

... 1 2 4 5 1 3 5 → Sorted measurement values: 1 3 **4** 5 5 Median_(n+1) = 4

7.4.4.2 Spike Correction

This special form of filtering is used to remove very high spikes from a relatively constant course of measurement values, though while retaining any smaller spikes. A median would remove all the spikes.

The assessment of whether a measurement is a spike (outlier) is based on the mean of a particular number of previous valid readings. The permissible deviation from the next value is calculated using the tolerance range. If the new measured value deviates too much, it will be corrected to the previous value. A maximum number of consecutive measured values to be corrected must also be stated.

Attention: In the event of several consecutive spikes (outliers), the previous corrected value is used in the correction of the following measured value. Use this function only in appropriate applications. Improper use can lead to a distortion of the measured value sequence! Check the possible impact of a changed measured value sequence on the measuring environment and subsequent controllers/systems.

This function acts the same way on all output distances; the differences (thicknesses) are calculated on the basis of the corrected distances.

- x Evaluation length. Number of previous measured values to be assessed (max. 10).
- y Max. tolerance range (mm); the spike (outlier) correction comes into play when the value is not met or is exceeded
- z Number of corrected value (max. 100)

Example: $x = 3 / y = 0.05 / z = 1$

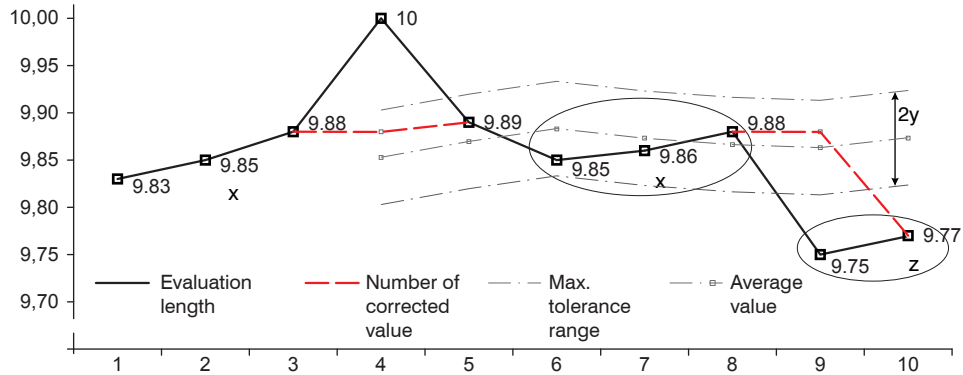
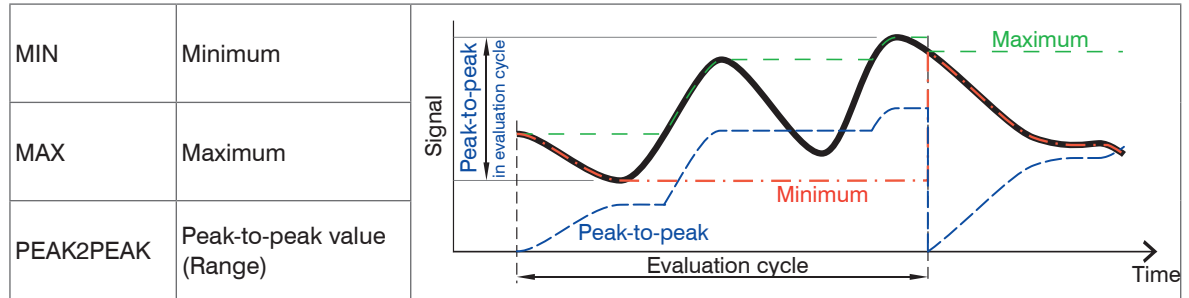

Fig. 31 Correction of measuring values

7.4.4.3 Statistical values

The optoNCDT 2300 can deduce the following statistical values from the result of measuring or the calculating:



Grey shaded fields require a selection.

Dark-bordered fields require you to specify a value.

Fig. 32 Statistical values and evaluation cycle

The statistical values are calculated from the measurement values within the evaluation cycle. With the command RESET STATISTICS, a new evaluation cycle (storage period) will be initiated. At the beginning of a new cycle, the old statistical values are deleted.

7.4.5 Setting Zero and Masters

By zeroing and mastering you can set the measurement value to a set point in the measuring range. The output range is moved thereby. This function makes sense, for example, for several adjacent measuring sensors or in the case of the thickness and planarity measurement.

Master value in mm	Value	Data, for example of the thickness, of a master piece. Value range max. $- 2 \times$ measuring range up to $+ 2 \times$ measuring range
--------------------	-------	--

Setting masters is used to compensate mechanical tolerances in the measurement setup of the sensors or to adjust the temporal (thermal) changes in the measurement system. The masters measurement, also a known as the calibration measurement, is given a set point.

The value which is given during measurement on the sensor output of the “mastering object“ is the “master value”. The zero-setting is a characteristic of the mastering, because here the master value is „0“.

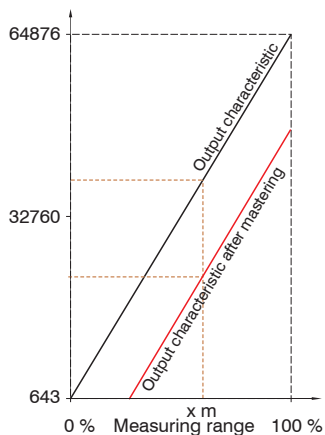

When mastering the sensor’s characteristic is parallel displaced. The displacement of the characteristic curve reduces the usable measurement range of the sensor the further the master value is away from the master position.

Sequence for mastering /Setting zero:

- ➡ Bring target and sensor in the desired position together.
- ➡ Send the master command.

The master command waits for 2 seconds on the next measurement value and masters it. If no measurement value is received within this time, for example by external triggering, the command returns with the error “E32 Timeout“ back.

After the mastering, the sensor gives new measurement values, related to the master value. The non-mastered condition applies by means of a reset with the button `Reset master value`.

Fig. 33 Characteristic for mastering

i “Setting masters“ or “Setting zero“ requires that a target is within the measurement range “Setting masters“ or “Setting zero“. “Setting masters“ and “Setting zero“ has an influence on the digital outputs.

7.4.6 Material Data Base

You can save the optical refractive indices of various materials in the sensor, that can be used for the measurement of direct reflection. The material database of the condition at delivery can be recovered by loading the factory settings. Up to 20 materials can be stored in the material database.

Material name	Value	General information on material
Material description	Value	
Refractive index n	Value	Optical refractive index of material

- Grey shaded fields require a selection.
- Dark-bordered fields require you to specify a value.

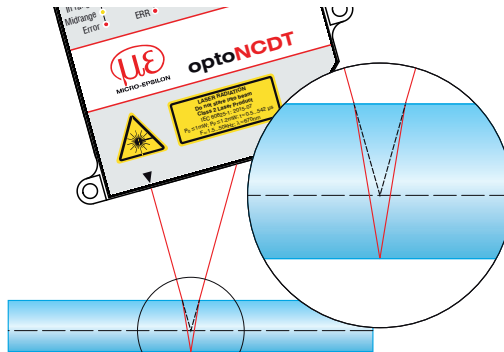

For measurements on transparent targets, such as films, it is due to the refractive index to smaller measurement values than it is actually the case. Is the respective material specified now for the measurement, the refractive index runs into the calculation and so the sensor delivers the correct result.

7.5 Data Output

7.5.1 Digital Interfaces

Selection of digital interfaces	<i>Web diagram / Ethernet measurement transmission / RS422</i>			<i>Decides via the used interface for measurement output. A parallel measurement output via multiple channels is not possible.</i>
Data selection	<i>Distance / Statistics Min / Statistics Max / Statistics peak-to-peak / Exposure time / Intensity of distance value / Status / Measured value counter / Time stamp / Trigger counter / Temperature</i>			<i>The data which are provided for the transmission are to activate with the checkbox.</i>
Settings Ethernet	IP settings of the base unit	Address type	<i>Static IP address / DHCP</i>	<i>When using a static IP address, values for IP address, gateway and subnet mask are to set; and this not applies when using DHCP.</i>
		IP address	<i>Value</i>	
		Gateway	<i>Value</i>	
		Subnet mask	<i>Value</i>	
	Settings of the Ethernet measurement value transmission	Transmission type	<i>Client / Server</i>	<i>The sensor as server provides the measurement values at the indicated port or sends them connection-oriented as client to the indicated client. The measurement value server is the destination of the measurement values and can be a PC or a PLC in the network. PC for programming/ demo programming are not measurement value server.</i>
		Protocol	<i>PCP/IP / UDP/IP</i>	
		IP address	<i>Value</i>	
		Port	<i>Value</i>	
Settings RS422	Baud rate	<i>9.6 / 115.2 / 230.4 ... / 4000 kBps</i>		<i>Transmission rate with binary data format.</i>
Ethernet/EtherCAT	Operation mode after start	<i>Ethernet/EtherCAT</i>		

7.5.2 Output Data Rate

Data reduction	<i>Value</i>	<i>Instructs the sensor, which data are excluded from the output, and thus the amount of transferred data is reduced.</i>
Reduction applies for	<i>RS422 / Ethernet</i>	<i>The interfaces, which are provided for the sub-sampling, are to be selected with the checkbox.</i>

You can reduce the measurement output in the sensor if you set the output of every nth measurement values in the Web interface or by command. The reduction value n can range from 1 (each measurement value) to 3.000.000. This allows you to adjust slower processes, such as a PLC, to the fast sensor without having to reduce the measuring rate.

7.6 Measurement Control

7.6.1 Triggering

Selected mode	<i>Level triggering</i>	<i>Measurement value input Measurement value output</i>	Measurement value output at	<i>Level low / Level high</i>	
	<i>Edge triggering</i>	<i>Measurement value input Measurement value output</i>	Start of measurement value output with	<i>Falling edge / Rising edge</i>	
			Number of measurement values	<i>Value</i>	<i>"0" stop triggering "1 ... 16382" values per trigger "16383" continuous data output</i>
	<i>Software triggering</i>	<i>Measurement value input Measurement value output</i>	Number of measurement values	<i>Value</i>	<i>"0" stop triggering "1 ... 16382" values per trigger "16383" continuous data output</i>
	<i>No triggering</i>				
Termination Sync/ Trig-input	<i>Checkbox</i>		Checkbox activates the terminating resistor for line matching.		

The optoNCDT 2300 measurement output is controllable through an external signal. Triggering does not influence the measuring rate respectively the timing, see Chap. 6.4, so that between the trigger event (level change) and the output reaction always lie 4 cycles + 1 cycle (Jitter). Micro-Epsilon recommends the abdication of data reduction, for example, by sub-sampling when the triggering is used.

The measurement value output rate in trigger mode can be controlled with the edge as well as the level of the trigger signal. Implemented trigger conditions:

Level triggering with high level / low level. Continuous measurement output, as long as the selected level is applied.

Then stops the data output. The pulse duration must be at least one cycle time. The subsequent break must also be at least one cycle time.

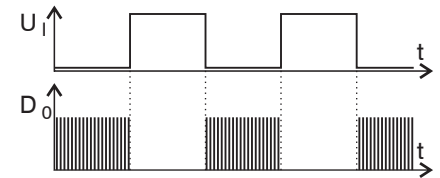

Fig. 34 Low trigger level (above) and digital output signal (below)

Edge triggering with rising or falling edge. After the trigger event the sensor outputs the preset number of measurement values or starts a continuous measurement value output. The pulse duration must be $5 \mu\text{s}$ at least.

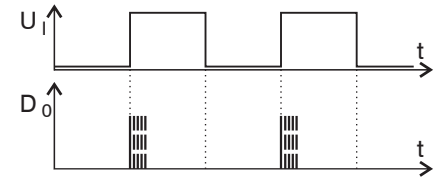

Fig. 35 Trigger edge LH (above) and digital output signal

Software triggering. Starts the measurement value output, when a software command comes. The trigger time is defined more inaccurately. After the trigger event the sensor outputs the preset number of measurement values or starts a continuous measurement value output. If "0" is selected for the number of measurement values, the sensor stops the triggering and the continuous value output.

The required signal levels comply to the EIA-422 specification. so that only driver circuits with RS422 output are recommended for triggering. The difference between both input signals Trig+ (pin 5) and Trig- (pin 6) must be according to amount greater than 400 mV.

The sensor detects a high level, if the voltage on Trig+ is greater than on Trig-. The optoNCDT 2300 contains a terminating resistor between pin 5 and 6 for line matching which can be connected via ASCII command.

The synchronous inputs are used for external triggering. So the sensors can alternatively be synchronized or triggered. The change between synchronization (default setting) and triggering is possible with the Web interface or ASCII command. Trigger source can be, for example, an encoder with RS422-level or a level converter which resets the TTL / HTL signals in RS422 level. Micro-Epsilon recommends the level converter SU4-x from LEG Industrie-Elektronik, see appendix. Maximum trigger rate $\leq 0.4 \cdot$ measuring rate

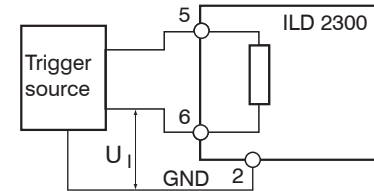
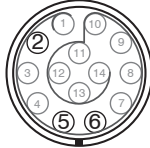
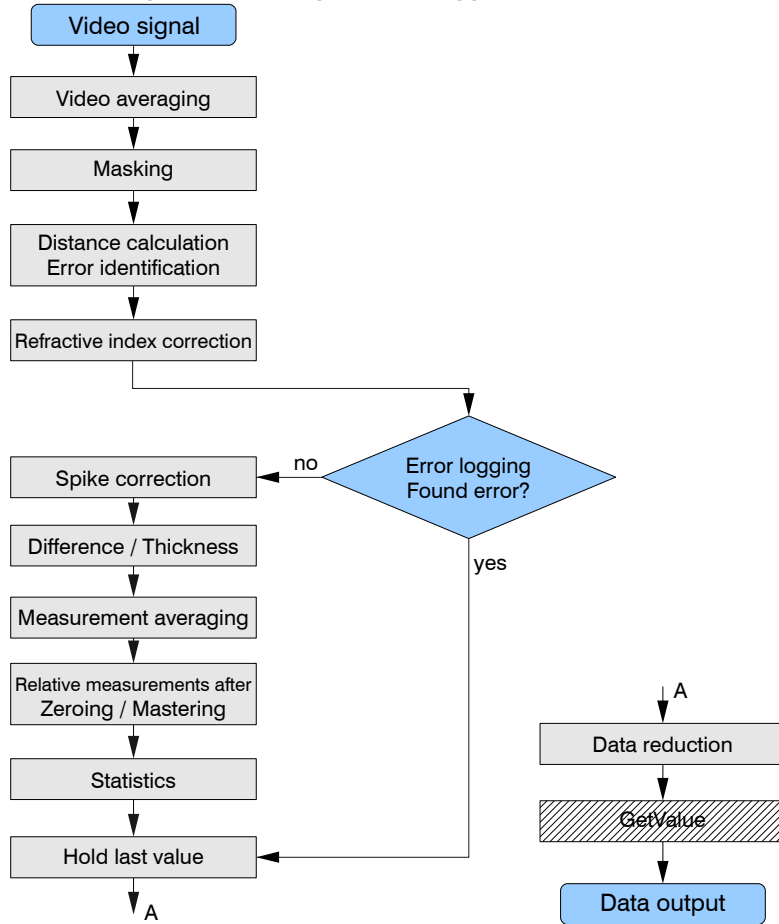

Fig. 36 Trigger wiring

Signal	Sensor		Extension cable PC2300
	Pin		
GND	2	 <p><i>Fig. 37 Sensor round connector, view on solder pin side male cable connector</i></p>	15-pol. Sub-D
Trigger-in/out	5		9
/Trigger-in/out	6		3
			11

7.6.1.1 Signal Processing without Trigger



7.6.1.2 Signal Processing - Value Output Trigger

Measurement values are calculated continuously and independently of the trigger event. A trigger event simply triggers the value output via a digital interface. Therefore, any values measured immediately before the trigger event are included in calculating mean values (averages) or statistics.

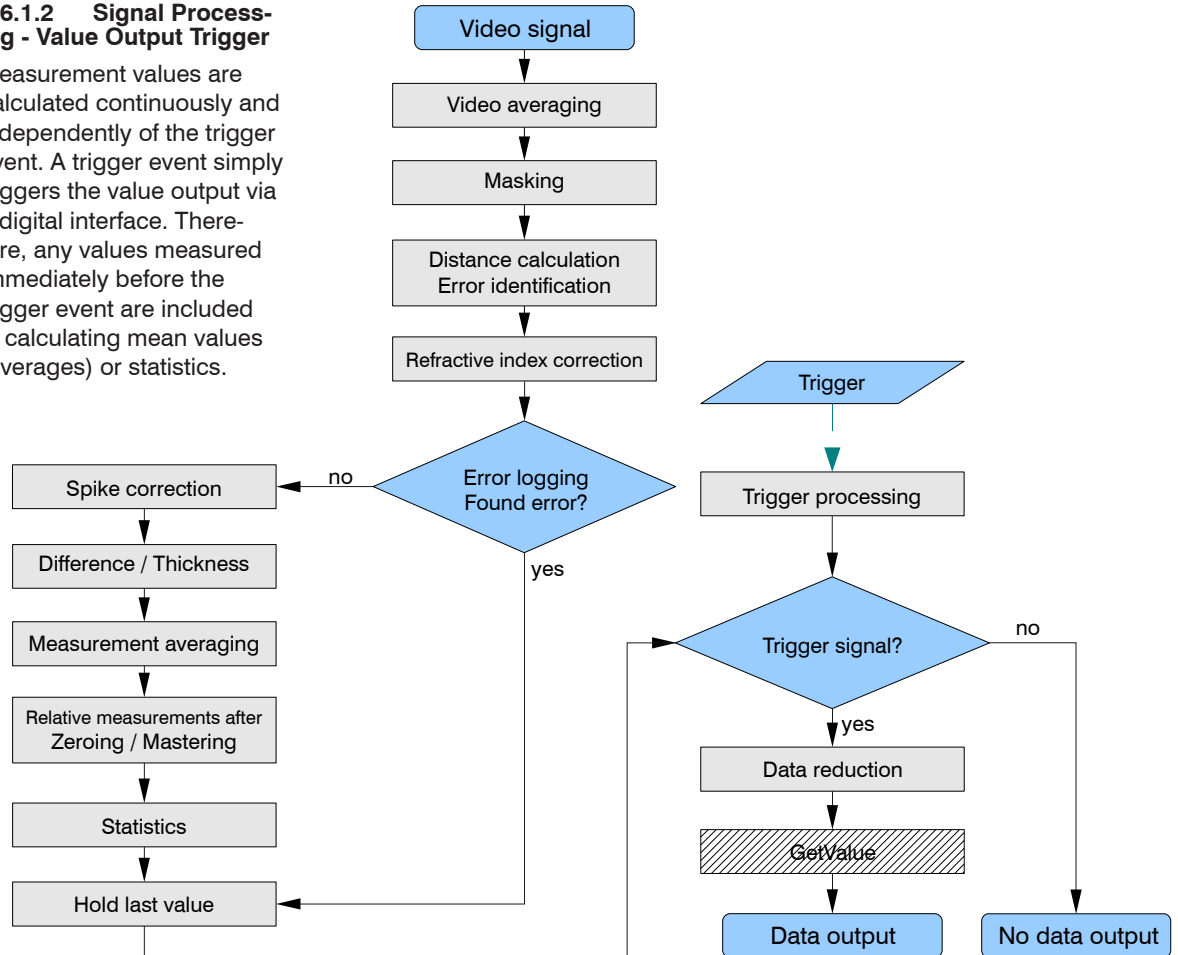

7.6.1.3 Signal Processing - Trigger for Acquiring Values

The current array signal is processed only after a valid trigger event, and it is used to calculate the measurement values. The measurement values are then forwarded for further calculation (e.g. averaging or statistics) and for output via a digital interface.

When calculating averages or statistics, measurement values recorded immediately before the trigger event cannot be included; instead older measurement values are used, which were recorded during previous trigger events.

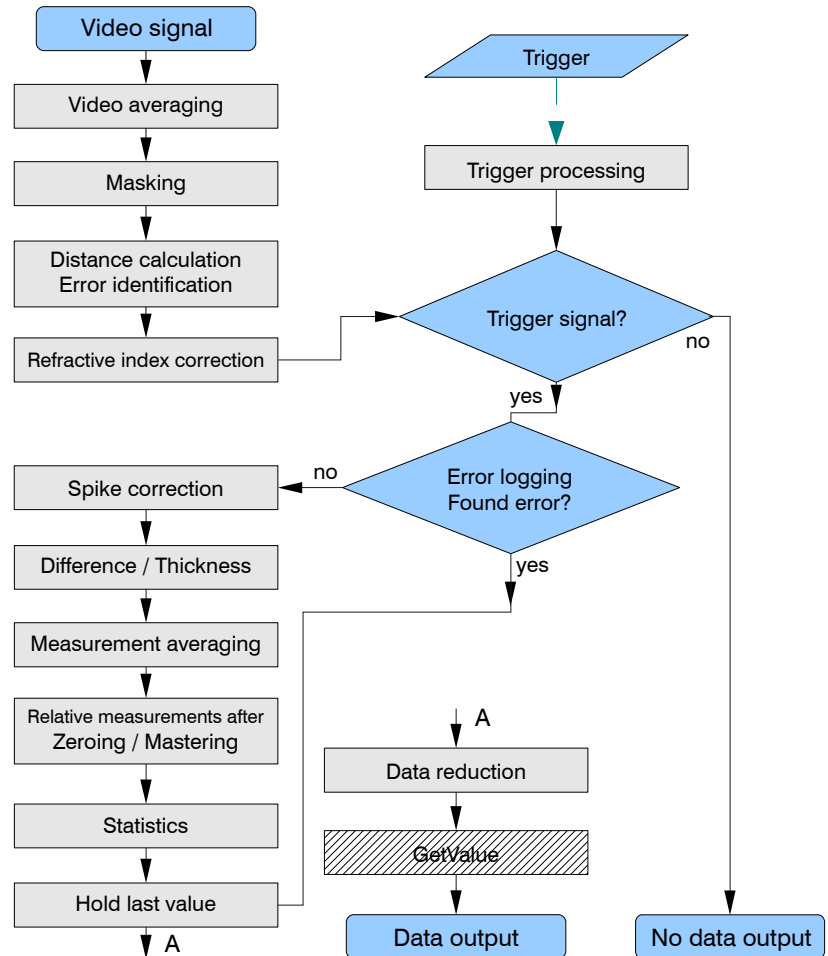

7.6.1.4 Signal Processing - Trigger for Outputting all Values

This setting acts the same as any selected trigger type; it supports the same trigger behavior settings as any other trigger type. The difference is that the trigger settings do not affect signal processing. Instead, trigger data are transferred using Bit 15 of the status word.

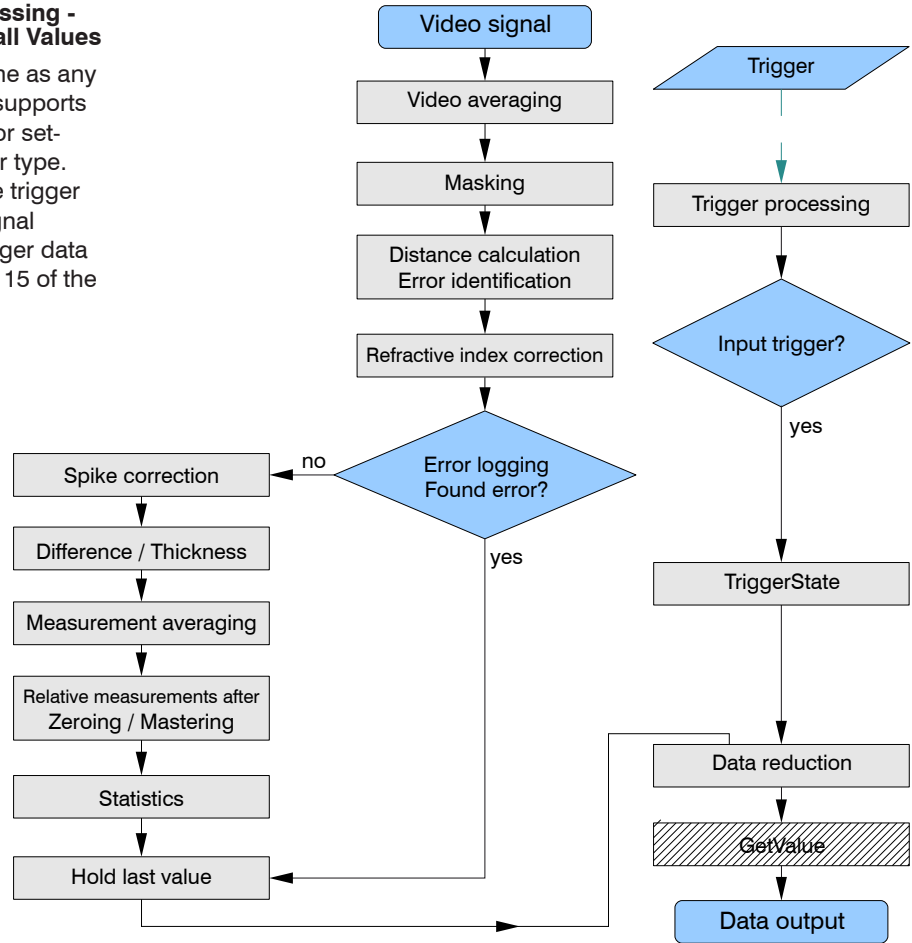

In contrast to the input trigger, Bit 15 of the status word is used as a marker for a trigger event.

Bit 15 == 0: no trigger event available.

Bit 15 == 1: trigger event available.

All trigger modes (level trigger, flank trigger, software trigger) are available.

State (output all values)

17, 16	15	14 ... 7	6	5	4	3	2	1	0
State LED	Trigger identifier	Reserved	Peak is located behind the measuring range	Peak is in front of the measuring range (MR)	not all peaks were calculated (peaks are too close together)	there are fewer peaks selected as applicable	there is no peak present	Peak ends to late	Peak starts to early
0 0 off	0 no trigger								
0 1 green	1 trigger								
1 0 red									
1 1 yellow									

In addition to the status word, this trigger event information is also available in the trigger counter which may be requested as additional data via Ethernet as an alternative to the status word. For more information, see Chap. 7.6.2, see Chap. A 6.5.2.5.

This instruction manual contains a number of additional helpful sections:

- For data format output values, measurement value frame Ethernet, see Chap. 8.2.2
- For measurement data transmission to a measurement value server, measurement value block, see Chap. 8.2.3
- Appendix, for communication with the sensor, see Chap. A 6.5
- For data selection optional values, see Chap. A 6.5.2.5

i The EtherCAT interface does not support the feature “signal processing – trigger to output all values“. Use Ethernet or RS422 to output all measurement values via the interface and to evaluate Bit 15 of the status word in order to assign trigger events to measurement values.

7.6.2 Trigger Counter

7.6.2.1 General

The trigger counter is used to supplement the existing additional information in the sensor.

Use one of the following for selection:

- Data Selection web interface page
- command OUTADD_ETH

These data are not available for the RS422 interface and in EtherCAT mode.

The trigger counter consists of the following 4 elements:

- trigger ID (T)
- trigger event counter (TriggEventCnt)
- trigger measurement value counter (TriggValueCnt)
- reserved bits (r)

31	30	29	28	27	26	25	24	23	22	21	20	19	18	17	16	15	14	13	12	11	10	9	8	7	6	5	4	3	2	1	0
T	r	TriggEventCnt														r	TriggValueCnt														

7.6.2.2 Trigger ID (T)

Depending on the selected trigger mode, Bit 31 will show if a trigger event is present:

- T == 1: trigger event available.
- T == 0: no trigger event.

Use the `TRIGGEROUT ALL` command to specify during trigger selection that all measurement values are going to be transferred and that T == 1 is used to mark the trigger event. In the gaps between two trigger events T == 0 is indicated.

7.6.2.3 Trigger Event Counter

The trigger event counter counts the number of trigger events. Each trigger edge (presets LH or HL) increases the counter by 1. The counter has a bit width of 14 bit which are the lower 14 bits of the counter's high part.

Use the `RESETCNT` command to reset the trigger event counter. The counter will be set to zero with the next trigger edge (preset) after processing the command.

Counting range: 0 ... 16383.

The counter starts with 0. It follows:

number of trigger events = trigger event counter + 1.

An overflow occurs after 16384 trigger events, and the counter will start again at 0, where $T = 1$.

7.6.2.4 Trigger Measurement Value Counter

The trigger measurement value counter is reset at each trigger edge (preset) and counts the number of measurement values within each trigger event. It follows:

- for level triggers: number of measurement values within the selected trigger level
- for edge triggers: from the selected trigger edge for the selected number of measurement values
- for software triggers: after completing the command for the selected number of measurement values

The counter has a bit width of 14 bit which are the lower 14 bits of the counter's low part.

Counting range: 0 ... 16383

The counter starts with 0.

It follows:

number of measurement values during a trigger event = trigger measurement value counter + 1.

7.6.2.5 Example

If the number of the measuring values per trigger event is set with `TRIGGERCOUNT` at e.g. 10, see Chap. [A 6.3.3.4](#), so `TRIGGVALUECNT` would count from 0 to 9.

7.6.2.6 Function

How the data output is assigned, depends on the selected trigger output.

Command `TRIGGEROUT TRIGGERED`

Trigger signal	-----	-----	-----
Measurements			
T	1 1 1 1	1 1 1 1 1 1	1
Trigger event counter	0 0 0 0	1 1 1 1 1 1	2
Trigger measurement counter	0 1 2 3	0 1 2 3 4 5	0

Command `TRIGGEROUT ALL`

Trigger signal	-----	-----	-----
Measurements			
T	1 1 1 1	0 0 0	1 1 1 1 1 0 0 0 0 1 1 1 0 0 0 0 1 1 1 0 0 0
Trigger event counter	0 0 0 0	0 0 0	1 1 1 1 1 1 1 1 1 1 1 1 2 2 2 2 2 2 2 2 2 2
Trigger measurement counter	0 1 2 3	3 3 3 3	0 1 2 3 4 4 4 4 4 0 1 2 2 2 2

7.6.2.7 Presets for Trigger Mode and Trigger Edge

The preset values for trigger mode and trigger edge are applied from the selections in the web interface `Settings > Trigger mode`. They can also be specified using the `TRIGGER`, `TRIGGERLEVEL`, `TRIGGER-COUNT` commands.

The following edge comes into effect after selecting the trigger counter:

Trigger mode	Trigger acts on	Effective trigger edge
Level triggering	low level	high / low
	high level	low / high
Edge triggering	falling edge	high / low
	rising edge	low / high
Software triggering		after execution of the command (no time reference)

7.6.3 Synchronization

Synchroni- zation mode	<i>Master on</i>	<i>Use at simultaneous synchronization</i>
	<i>Master on alternating / Slave in</i>	<i>Use at alternating synchronization</i>
	<i>No synchronization</i>	
Termination Sync/ Trig-input	<i>Checkbox</i>	<i>Checkbox activates the terminating resistor for line matching.</i>

If two or more optoNCDT 2300 measure against the same target, the sensors can be synchronized. The optoNCDT 2300 distinguishes between two types of synchronization.

NOTICE

The synchronous connections may not be temporarily connected to the operating voltage and / or GND.

Risk of destruction of the sensor by overloading

Type	Used for	
Simultaneous synchronization	Both sensors measure in the same cycle	Measurement of differences (thickness, difference in height) on opaque objects. Here, Sensor 1 must be programmed as the “Master” and Sensor 2 as the “Slave”.
Alternating synchronization	Both sensors measure alternatively Output rate \leq measuring rate / 2	Thickness measurements on translucent objects or measurements of difference on closely spaced measurement points. The alternating synchronization requires that the lasers are switched on and off alternately so that the two sensors do not interfere with each other optically. Therefore one sensor is to program as “Master alternating” and one as “Slave”. There can be only one master to be connected to a slave.

Fig. 38 Characteristics of and uses for the different types of synchronization

i Do not run the sensor not synchronized. Synchronized sensors must be adjusted to the same measuring rate. Do not ever connect two masters with each other.

Measuring rate [kHz]	1.5	2.5	5	10	20	30	49.140
Synchronization rate [kHz]	1.43 ... 1.5	2.4 ... 2.5	4.8 ... 5	9.5 ... 10	19 ... 20	28.5 ... 30	46.6 ... 49

Fig. 39 Tolerances for the synchronization rates

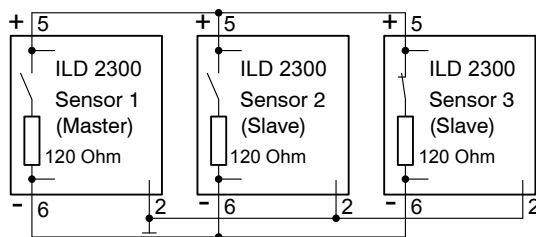

The signals Sync-in/out or /Sync-in/ of same polarity are connected in parallel with each other. A sensor is to program as a synchronous master, which supplies the subsequent slave sensors with symmetric synchronous pulses, RS422-level. Only in the last slave sensor in the chain the terminating resistor is activated of 120 Ohm, see Chap. 7.6.3. The system grounds (pin 2) of the sensors are to connect to each other.

Signal	Sensor		Extension cable PC2300
	Pin		
GND	2	 <p><i>Fig. 40 Sensor round pin plug, view: Solder-pin side male cable connector</i></p>	15-pol. Sub-D
Sync-in/out	5		9
/Sync-in/out	6		3
			11

If you synchronize the sensor with an external signal source, the levels of the signal source have to comply with the EIA-422-specifications. The difference between both input signals Sync+ (pin 5) and Sync- (pin 6) must be according to amount greater than 400 mV. Synchronization source may be, for example, a level converter, which converts TTL/HTL signals into RS422 level. Micro-Epsilon recommends the level converter SU4-1 from LEG Industrie-Elektronik. The synchronization rate is to take from the table, see Fig. 39. Pulse duration and non-pulse period have a ratio of 1:1.

Input or output is to select according to the type of synchronization.

7.7 Loading, Saving, Extras

7.7.1 Loading/Saving Settings

All settings on sensor, for example measuring rate and averaging, can be permanently saved in application programs, so-called set of parameters.

Load / save settings	Setup no.:	1 / 2 / 3 ... 8	<i>Selection of the set of parameters to be load/save. The user selects a number when loading/saving a complete configuration. Allows fast duplicating of sets of parameters.</i>
	Keep interface settings	Checkbox	<i>You should load the interface settings only when the sensor is operated on different networks respectively with different baud rates of the RS422 interface.</i>
	Activate	Button	<i>If you press Activate the upper selected set of parameters is loaded from the internal memory of the sensor.</i>
	Save setup	Button	<i>The current sensor settings are stored in the selected set of parameters in the internal memory of the sensor.</i>
Manage setups on PC	Data selection for transmission	Setup / material data base	<i>A set of parameters contains settings for measuring, for example measuring rate and the interface settings. The material data base contains refractive indices of different materials.</i>
	Setup no.:	1 / 2 / 3 ... 8	<i>Selection of the set of parameters to be load/save. The user selects a number when loading/saving a complete configuration. Allows fast duplicating of sets of parameters.</i>
	Export setup	Button	<i>If you press Export the download manager of your browser opens and offers to save the setting values in a specified file "setup. meo" in the PC.</i>
	Keep interface settings	Checkbox	<i>You should load the interface settings only when the sensor is operated on different networks respectively with different baud rates of the RS422 interface.</i>
	Browse / import	Button	<i>If you press Browse ... Windows opens the selection window to select a configuration file saved in the PC. By opening the selected file in the selection window, the path is cached. Loading the file will be effected by the Import setup button.</i>

i After programming all the settings are to be saved permanently as a set of parameters, so the next time you turn on the sensor they are available again.

If the settings under the selected parameter set no. are saved in the sensor, it works with the new values after the loading process. It is therefore not a new boot process in the sensor performed. The parameter-set which was saved last will be loaded when the sensor is switched on.

7.7.2 Extras

Language		<i>German / English</i>	<i>Language of the interactive websides.</i>
Unit		<i>mm / inch</i>	<i>Units in the measurement representation</i>
Factory settings	Only reset the material data base	<i>Checkbox</i>	<i>Allows to replace only the values in the material database.</i>
	Interface settings maintained	<i>Checkbox</i>	<i>This enables to leave all the settings for the Ethernet and the RS422 interface unchanged.</i>

8. Digital Interfaces

8.1 Preliminary Remarks

The optoNCDT 2300 sensor has two digital interfaces, which can alternatively be used to data output but parallel to the parameterization.

- Ethernet provides a quick non-real-time capable data transmission (packet-based data transfer). Measurement values and video data can be transmitted. The configuration of the sensor can be done via the web interface or by ASCII commands. Furthermore, the program ICONNECT from Micro-Epsilon is also suitable for communication with the optoNCDT 2300 via Ethernet.
- RS422: A real-time capable interface with a lower data rate is provided through the RS422 interface. No video data can be transmitted via this interface; the output is limited to a maximum of two output values in binary format. The configuration is done via the web interface or through ASCII commands.
- EtherCAT: The sensor features a real-time interface.

Recommendation:

- Ethernet: For a measurement value acquisition without direct process control, for a subsequent analysis. The configuration is done via the web interface or through ASCII commands.
- EtherCAT: Process control. The measurement value output is done in real time and is bus-compatible.
- RS422: Process control. The measurement value output is done in real time.

8.2 Ethernet

8.2.1 Default Settings

The following default settings (factory setting) can be used for an initial connection to the sensor.

The sensor is set to static IP address ex factory.

You need a web browser (for example Mozilla Firefox or Internet Explorer) on a PC with network connection.

Decide whether you connect the optoNCDT 2300 to a network or directly to a PC.

In the sensor, dynamic web pages are generated that contain the current settings of the sensor. The operation is only possible as long as an Ethernet connection to the sensor exists.

8.2.2 Data Format Output Values, Measurement Value Frame Ethernet

All values to be output at the same time are combined to form a frame for Ethernet transmission.

Structure of a measurement value frame:

- Video signal and/or corrected video signal ($n * 512 \text{ pixel} * 16 \text{ bit}$)
- Exposure time ($1 * 32 \text{ bit}$)
- Measured value counter ($1 * 24 \text{ bit}$)
- Time stamp ($1 * 32 \text{ bit}$)
- Temperature value ($1 * 32 \text{ bit}$)
- Displacement values / intensities ($n * (i + 1) * 32 \text{ bit}$)
- Status ($1 * 32 \text{ bit}$)
- Trigger counter ($1 * 32 \text{ bit}$)
- Differences ($(n-1) * 32 \text{ bit}$)
- Statistical values (Min/Max/Peak2Peak) (each 32 bit)

$n = 1 / 2$

For $n = 1$: Displacement measurement (diffuse / direct reflection)

For $n = 2$: Difference = thickness (direct reflection)

$i = 0 / 1$

For $i = 0$: Intensity output is off

For $i = 1$: Intensity output is on

A measurement value frame is constructed dynamically, that is, not selected values, see Chap. [A 6.5.2](#) are not transmitted. Output order: Intensity before displacement value

Video signal

Video signals can be transmitted, which were calculated in the signal processing. For each pixel the corresponding 16 bits of the individual signals are transmitted consecutively.

Options with 2 signals:

„Raw signal 1“ / „Filtered signal 1“

- „Raw signal 2“ / „Filtered signal 2“
- „Raw signal 3“ / „Filtered signal 3“

Options with one signal:

- „Raw signal 1“ / „raw signal 2“
- „Raw signal 3“ / „raw signal 4“

Exposure time

The exposure time is transmitted with each displacement value.

Bit 31 ... 17	16 ... 0
Reserved	Exposure time, step size 12.5 ns Value range: 12.5 ns ... 1.3107 ms

If the exposure time is transmitted via the RS422, only bit 0 ... 16 is transmitted.

Measured value counter

The measured value counter allows the assignment of the video signal.

Bit 31 ... 24	23 ... 0
Reserved	Counter

In case of the measured value counter is transmitted via the RS422, only bit 0 ... 17 is transmitted; so the counter is limited to 262143 values. Then the measured value counter starts again with 0.

Time stamp

Transmission of the time stamp as a 32 bit value. The resolution is 1 μ s.

Bit 31 ... 0
Time stamp

In case of the time stamp is transmitted via the RS422, only bit 8 ... 25 are transmitted. The resolution is then 0.25 ms.

Temperature

10-bit integer with the correct sign extended to 32 bits, resolution 0.25 °C.

Temperature DB9 . . . DB0

-128 °C	10 0000 0000	-50 °C	11 0011 1000	+0.25 °C	00 0000 0001	+75 °C	01 0010 1100
-125 °C	10 0000 1100	-25 °C	11 1001 1100	+10 °C	00 0010 1000	+100 °C	01 1001 0000
-100 °C	10 0111 0000	-0.25 °C	11 1111 1111	+25 °C	00 0110 0100	+125 °C	01 1111 0100
-75 °C	10 1101 0100	0 °C	00 0000 0000	+50 °C	00 1100 1000	+127 °C	01 1111 1100

The temperature range is limited to -55 ° ... +127 °C. The operating temperature of the sensor is 0 ... +50 °C.

Displacement values, differential values, intensity

An intensity for each selected displacement, if selected, is transmitted.

Maximum 2 measurement values can be transmitted by direct reflection.

Displacement or differential value

Ethernet: The displacement values or the differential value were shown as a signed integer value (32 bit) with a resolution of 1 nm.

RS422: The displacement values or the differential value were shown with a resolution of 16 bit, while the value range is 18 bit. This means, that even D16 and D17 stand in the H-byte, when through a denser medium with a refractive index >1, maximal 4, is measured through, see Chap. 8.3.

Intensity

Bit 31 ... 25	24 ... 14	13 ... 10	9 ... 0
Reserved	Maximum of the peak (from the corrected signal)	Reserved	Intensity of the peak

If the intensity is transmitted via the RS422, only bit 0 ... 9 is transmitted.

Status

17, 16	15	14 ... 7	6	5	4	3	2	1	0
Status LED 0 0 off 0 1 green 1 0 red 1 1 yellow	Trigger identifier 0 no trigger 1 trigger	Reserved	Peak is located behind the measuring range	Peak is in front of the measuring range (MR)	not all peaks were calculated (peaks are too close together)	there are fewer peaks selected as applicable	there is no peak present	Peak ends to late	Peak starts to early

If the status is transmitted via the RS422, only bit 0 ... 17 is transmitted. Bit 0 ... 6 is identical to the error codes RS422.

Trigger counter

Bit 31	30	29 ... 16	15, 14	13 ... 0
Identification of the trigger	Reserved	Trigger event counter (TriggEventCnt)	Reserved	Trigger measuring value counter (TriggValueCnt)

The trigger counter can not be transferred with the RS422.

Differential value

Calculated differential values between two displacements have the same format as the displacement values

Statistical values

The statistical values have the same format as the displacement values. First the minimum, then maximum and at the end Peak2Peak are transmitted, if selected.

8.2.3 Measurement Data Transmission to a Measurement Value Server, Measurement Value Block

Different measurement value frames are combined to a measurement value block and surrounded by another header. This header gives information on the data contained and its length. The header (Byte sequence „Little Endian“) is mandatory at the beginning of a UDP or TCP packet.

In case of measurement value data transmission to a measurement value server, the sensor sends each measurement value block to the measurement value server or to a connected client after successful connection (TCP or UDP). Therefore no explicit requirement is necessary.

By changes of the transmitted data or the frame rate a new header is sent automatically.

Preamble (32 bit)	
Order number (32 bit)	
Serial number (32 bit)	
Flags 1 (32 bit)	
Flags 2 (32 bit)	
Frame number (16 bit)	Bytes per frame (16 bit)
Counter (32 bit)	

Fig. 41 Measurement value block header

Header registration	Description
Preamble	Identifies the header = 0x4D454153 /* MEAS */
Order number	Order number of the sensor
Serial number	Serial number of the sensor
Flags 1	Give information on the contents of the output values
Flags 2	Give information on the contents of the output values
Bytes per frame	Number of bytes, that contain a measurement value frame
Frame number	Number of frames, that cover this header
Counter	Counter about the number of processed measurement values

Fig. 42 Inputs in the measurement value block header

Flag-bit	Description
0	Video raw signal
1	Video corrected
2	Shutter
3	Profile counter
4	Time stamp
5	Temperature
6 up to 7	Reserved
8	Intensity output
9	Reserved
10	Measurement value output
11	Reserved
12 up to 13	Measurement values/Intensities of peak 1 up to 2
14 up to 15	Reserved
16	Status
17, 18	Reserved
19	Trigger counter
20 up to 31	Reserved

Fig. 43 Description Flags 1

Flag-Bit	Description
0	Thickness of peak 1 up to peak 2
1 up to 5	Reserved
6	Statistics minimum
7	Statistics maximum
8	Statistics peak-peak
9 up to 31	Reserved

Fig. 44 Description Flags 2

8.2.4 Ethernet Video Signal Transmission

The video signal is effected analogously to the data transmission to a measurement value server via Ethernet, except that only one raw signal or one filtered signal or one raw signal and one filtered signal is transmitted in a measurement value block, and each video signal transmission must be requested separately. This measurement value block can span multiple TCP / IP or UDP / IP packets depending on the size of the video signal. The preamble for the video signals is 0x56494445 / * VIDE * /.

8.3 RS422

The interface RS422 has a maximum baud rate of 4000 kBaud. The factory-set baud rate is 691.2 kBaud. The measuring rate is maximum 49,140 kHz.

Data format: Measurement values in binary format, commands as an ASCII string.

Interface parameter: 8 Data bits, no parity, one stop bit (8N1).

i Disconnect or connect the D-sub connection between RS422 and USB converter when the sensor is disconnected from power supply only.

Measurement data format

16 Bit ¹ are transmitted per output value. An output value is divided into three bytes that differ in the two most significant bits. The transmission of additional output values is optional.

Output value 1 / additional:

L-Byte	0	0	D5	D4	D3	D2	D1	D0
M-Byte	0	1	D11	D10	D9	D8	D7	D6
H-Byte	1	0 ²	0 ³	0 ³	D15	D14	D13	D12

1, 3) Displacement and difference values are converted with a value range of 18 bits for measurements on targets with a refractive index greater than 1, maximum 4. This means that also there are D16 and D17 in H-Byte.

2) To decide between the 1st output value and additional output values, bit 7 in the H-Byte is set to 1. Bit 7 in the H-Byte is set to 0 for the 1st output value. This simultaneously represents the identifier of a new block. Depending on the measuring rate, baud rate and output data rate output all data can be output in one block. If data output is not possible, a run-time error will be output. Use the command GETOUTINFO_RS422 to query for data selection and output sequence.

Conversion of the binary data format

For conversion purposes the H-Byte, M-Byte and L-Byte must be identified on the basis of the two first bits (flag bits), the flag bits deleted and the remaining bits compiled into a 16 or 18 bit data word.

Result of conversion

D17	D16	D15	D14	D13	D12	D11	D10	D9	D8	D7	D6	D5	D4	D3	D2	D1	D0
-----	-----	-----	-----	-----	-----	-----	-----	----	----	----	----	----	----	----	----	----	----

Conversion must be done in the application program. D16 and D17 are used only for measurements in optically heavy materials with a refractive index greater than 1 and to interpret the error codes.

i The sensor continues to deliver measurement values to the RS422 output even while communicating with the sensor.

For the data transfer with a PC the MICRO-EPSILON IF2008 PCI BUS interface card is suitable. This can be connected to the sensor via the PC2300-x/IF2008 interface cable, which is also available as an option. The IF2008 combines the three bytes for the data word and saves them in the FIFO. The 16 bits are used for measurement values and error values. As standard, the IF2008 interface card is suitable for connecting two or (via a Y intermediate cable available as an option) up to four sensors plus two additional incremental encoders. For further information, please refer to the descriptions of the IF2008 interface card and associated MEDAQLib driver program.

You will find the latest program routine at: www.micro-epsilon.com/link/software/medaqlip.

8.4 EtherCAT

The sensor can communicate via the Ethernet connector (PC2300-0, 5 / Y) with an EtherCAT system.

Advantages:

- Fast data transmission,
- Parameterization of the sensor.

A connection of the sensor to an EtherCAT environment is possible with a 2-port EtherCAT junction or a RS422 extension terminal, see Chap. 5.3.6 documentary about EtherCAT you also will find in the appendix, see Chap. A 7.

The description on the sensors XML file you will find on the supplied CD. See the file “optoNCDT2300.xml”.

8.5 Change Ethernet to EtherCAT

You can switch between Ethernet and EtherCAT via an ASCII command, see Chap. A 6.3.4.4, via a web browser, see Chap. 7.5.1, or EtherCAT object, see Chap. A 7.11. The switching is done after restarting the sensor. Save the current settings before switching to EtherCAT.

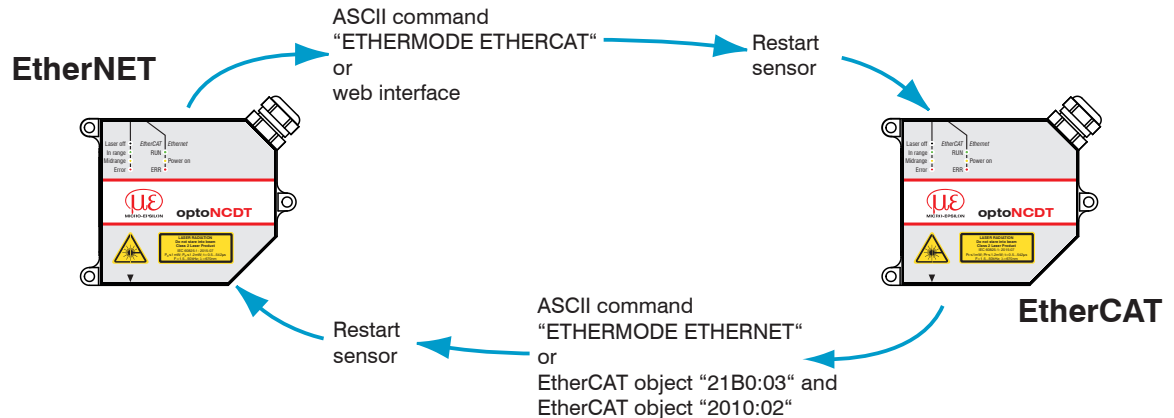

The RS422 interface for transmitting an ASCII command is available both in Ethernet and EtherCAT mode.

9. Value Output

The optoNCDT 2300 outputs the measurements are either via the RS422 or Ethernet. Both output types can not be used simultaneously.

	Video signals	Temperature	Shutter time	Profile counter	Time stamp	Trigger counter	Measurements	Error field	Differences	Statistics
RS422 ¹⁾		x	x	x	x		x	x	x	x
Ethernet	x	x	x	x	x	x	x	x	x	x

Fig. 45 Existing output values for the interfaces

i Use the commands `GETOUTINFO_ETH` and `GETOUTINFO_RS422` to check the set output values at the interfaces, see Chap. [A 6.5.2.1](#).

9.1 RS422

The digital measurement values are issued as unsigned digital values (raw values). 16 Bit per value are transmitted. One or two 16-bit values are transmitted. Examples: a displacement value or two displacement values or a displacement value plus an optional reading or two optional readings. The formula also applies to values that are encoded with 18 bits, see Chap. [8.3](#).

Value range		Calculation of a measurement value in mm from digital output
0 ... 65519	(16 Bit - 16)	
0 ... 642	SMR back-up	$x \text{ [mm]} = \left(\text{digital}_{\text{OUT}} * \frac{1.02}{65520} - 0.01 \right) * \text{Measuring range [mm]} \text{ } ^1$
643 ... 64876	Measurement range	
64877 ... 65519	EMR back-up	

Fig. 46 Calculation and output of distance values

$$x \text{ [mm]} = \left(\text{digital}_{\text{OUT}} * \frac{1.02}{65520} \right) * \text{measuring range [mm]}$$

Fig. 47 Calculation of thickness values

- 1) Reference is start of measuring range, distance measurement, thickness measurement
- 2) If Mastering is used only distance measurement

With the difference generating in the sensor for the thickness calculation the offset is omitted:

$$\text{Thickness} = \text{distance 2} + \text{offset} - (\text{distance 1} + \text{offset})$$

Example distance measuring:

Digital Out	Calculation	Result	
32760	$(32760 * 15.5677E-6 - 0.01) * 10 \text{ mm}$	5 mm	(midrange)
16758	$(16758 * 15.5677E-6 - 0.01) * 10 \text{ mm}$	2.509 mm	
643	$(643 * 15.5677E-6 - 0.51) * 10 \text{ mm}$	0.0001 mm	(SMR)



The video signal can not be transmitted via the RS422 interface.

9.1.1 Possible Output Values and Output Sequence (RS422)

The selected values are output in the following order:

- Exposure time
- Profile counter
- Time stamp
- Temperature
- Intensity(ies)
- Distance value(s)
- Status
- Trigger counter (with Ethernet only)
- Thickness (difference from distance values)
- Minimum
- Maximum
- Peak to Peak

i Use the commands `GETOUTINFO_ETH` and `GETOUTINFO_RS422` to check the set output values at the interfaces, see Chap. [A 6.5.2.1](#).

9.1.2 Error Codes

Error code	Description
262073	Scaling error RS422 interface underflow
262074	Scaling error RS422 interface overflow
262075	Too much data for selected baud rate ¹
262076	No peak available
262077	Peak is in front of the measuring range
262078	Peak is after the measuring range
262079	Measurement can not be calculated
262080	Measurement can not be evaluated, global error ²
262081	Peak is to wide
262082	Laser beam is off

Fig. 48 Digital error codes RS422

1) This error occurs, if more data should be output, as the may be transmitted with baud rate and measuring rate selected. To fix the error, there are the following possibilities:

- increase baud rate
- decrease measuring rate
- reduce data amount
 - if two data words selected, reduce to one data word
 - reduce output rate

See the following sections:

BAUDRATE, MEASRATE, OUTREDUCE, OUTSTATISTIC_RS422, OUTDIST_RS422, OUTTHICK_RS422

2) This error occurs, if one of the selected peaks is not fully evaluated, because a part of a peak is not recorded. The reasons may be:

- a part of a peak is not recorded by the sensor (before or after the valid measuring range)
- at 49,140 kHz a part of a peak is within the reduced measuring range which is nor used
- when using the ROI a part of a peak is outside the selected range

9.2 Ethernet

The digital measurement values are issued as signed digital values (raw values). 32 Bit Signed Integer per value are transmitted. Value range is from -2,147 mm up to +2,147 mm with 1 nm resolution. The distance values are output in nanometers.

Error code	Description
0x7fffffb	No peak available
0x7fffffa	Peak is in front of the measuring range
0x7fffff9	Peak is after the measuring range
0x7fffff8	Measurement can not be calculated
0x7fffff7	Measurement can not be evaluated, global error ¹
0x7fffff6	Peak is to wide
0x7fffff5	Laser beam is off

Fig. 49 Error codes Ethernet interface

1) This error occurs, if one of the selected peaks is not fully evaluated, because a part of a peak is not recorded. The reasons may be:

- a part of a peak is not recorded by the sensor (before or after the valid measuring range)
- at 49,140 kHz a part of a peak is within the reduced measuring range which is nor used
- when using the ROI a part of a peak is outside the selected range

9.3 EtherCAT

A documentary about data selection and data formats you will find in the appendix, see Chap. [A 7](#).

9.4 Analog Output

An analog output of the sensor is possible with an optional controller CSP2008.

9.5 Error Handling

The measurement output of the optoNCDT 2300 sensor in case of an error can be done in different ways:

- Error output: No holding the last measurement value, output of error value
- Keep last value infinitely: Infinite holding of the last measurement value
- Keep last value: Holding the last measurement value on n numbers of measuring cycles; then an error value (maximum of 1024) is output. The number (n) of error values to be skipped can be specified via the web interface or command.

The command OUTHOLD sets the behavior of the measured value output, see Chap. [A 6.5.1.3](#).

10. Instructions for Operating

10.1 Reflection Factor of the Target Surface

In principle the sensor evaluates the diffuse part of the reflected laser light.

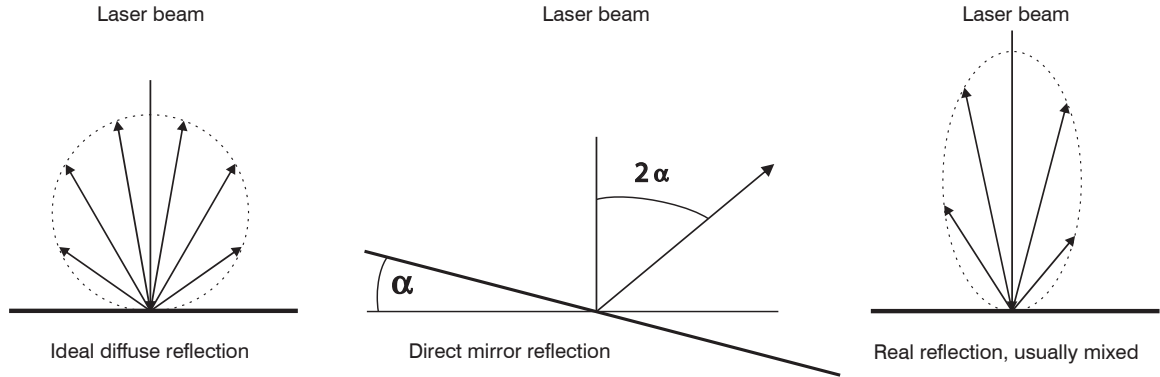

Fig. 50 Reflection factor of the target surface

A statement concerning a minimum reflectance is difficult to make, because even a small diffuse fraction can be evaluated from highly reflecting surfaces. This is done by determining the intensity of the diffuse reflection from the CMOS signal in real time and subsequent compensation, see Chap. 3.2. Dark or shiny objects being measured, e.g. black rubber, may require longer exposure times. The exposure time is dependent on the measuring rate and can only be increased by reducing the sensor's measuring rate.

10.2 Error Influences

10.2.1 Light from other Sources

Thanks to their integrated optical interference filters the optoNCDT 2300 sensors offer outstanding performance in suppressing light from other sources. However, this does not preclude the possibility of interference from other light sources if the objects being measured are shiny and if lower measuring rates are selected. Should this be the case it is recommended that suitable shields be used to screen the other light sources. This applies in particular to measurement work performed in close proximity to welding equipment.

10.2.2 Color Differences

Because of intensity compensation, color difference of targets affect the measuring result only slightly. However, such color differences are often combined with different penetration depths of the laser light into the material. Different penetration depths then result in apparent changes of the measuring spot size. Therefore color differences in combination with changes of penetration depth may lead to measuring errors.

10.2.3 Surface Roughness

In case of traversing measurements surface roughnesses of 5 μm and more lead to an apparent distance change (also-called surface noise). However, they can be dampened by averaging, see Chap. 7.4.4.

10.2.4 Temperature Influences

When the sensor is commissioned a warm-up time of at least 20 minutes is required to achieve uniform temperature distribution in the sensor. If measurement is performed in the micron accuracy range, the effect of temperature fluctuations on the sensor holder must be considered. Due to the damping effect of the heat capacity of the sensor sudden temperature changes are only measured with delay.

10.2.5 Mechanical Vibration

If the sensor should be used for resolutions in the μm to sub- μm range, special care must be taken to ensure stable and vibration-free mounting of sensor and target.

10.2.6 Movement Blurs

If the objects being measured are fast moving and the measuring rate is low it is possible that movement blurs may result. Always select a high measuring rate for high-speed operations, therefore, in order to prevent errors.

10.2.7 Angle Influences

Tilt angles of the target in diffuse reflection both around the X and the Y axis of less than 5° only have a disturbing effect with surfaces which are highly reflecting. Tilt angles between 5° and 15° lead to an apparent distance change of approximately 0.12 ... 0.2 % of the measuring range.

Tilt angles between 15° and 30° lead to an apparent distance change of approximately 0.5 % of the measuring range.

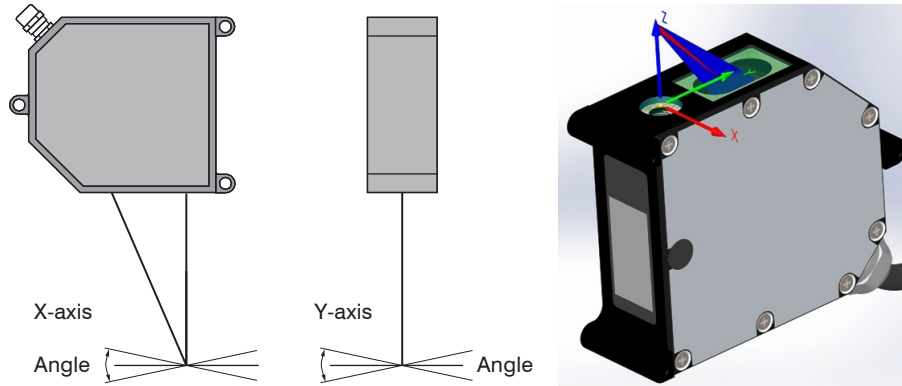
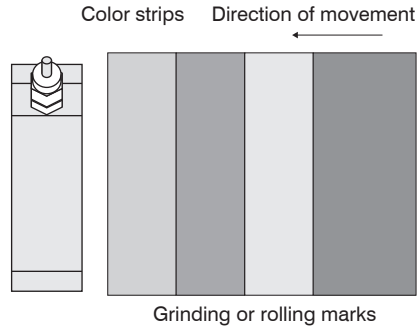

Fig. 51 Angle influences

Angle	X-axis %	Y-axis %
$\pm 5^\circ$	typ. 0.12	typ. 0.12
$\pm 15^\circ$	typ. 0.2	typ. 0.2
$\pm 30^\circ$	typ. 0.5	typ. 0.5

Fig. 52 Measurement errors through tilting with diffuse reflection

10.3 Optimizing the Measuring Accuracy



In case of rolled or polished metals that are moved past the sensor the sensor plane must be arranged in the direction of the rolling or grinding marks. The same arrangement must be used for color strips.

Fig. 53 Sensor arrangement in case of ground or striped surfaces

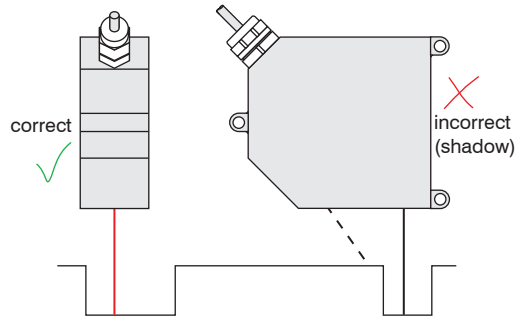

In case of bore holes, blind holes, and edges in the surface of moving targets the sensor must be arranged in such a way that the edges do not obscure the laser spot.

Fig. 54 Sensor arrangement for holes and ridges

10.4 Cleaning

A periodically cleaning of the protective housings is recommended.

Dry cleaning

This requires a suitable optical antistatic brush or blow off the panels with dehumidified, clean and oil free compressed air.

Wet cleaning

Use a clean, soft, lint-free cloth or lens cleaning paper and pure alcohol (isopropanol) for cleaning the protective housing.

Do not use commercial glass cleaner or other cleansing agents.

10.5 Protective Housing

The protective housing are designed to be used especially if the sensor operates in diffuse reflection mode and in a dirty environment or higher ambient temperature. It is available as an accessory. If these protective housings are used, the linearity of the sensors in the complete system may deteriorate. For the sole purpose of protection against mechanical damage a simple protective shield with sufficiently large opening is therefore more advantageous. Installation of the sensors in the protective housings should be performed by the manufacturer, because especially in case of short reference distances the protective window must be included in the calibration.

10.5.1 Versions

- SGH size S, M: without air purging (with inlet and exhaust for cooling) and
- SGHF size S, M: with air purging.

10.5.2 Guidelines

- The maximum ambient temperature within the protective housing is 45 °C.
- The requirements for compressed-air are:
 - Temperature at the inlet < 25 °C
 - The compressed-air must be free of oil and water residues. It is recommended to use two oil separators in series arrangement.
- With a flow rate for example 240 l/min (2.5E+5 Pa or 36.2 psi) the maximum outside temperature is 65 °C.
- For higher ambient temperatures it is recommended to use an additional water-cooled carrier and cover plates outside the protective housing.
- No direct heat radiation (including sunlight!) on the protective housing. In case of direct heat radiation additional thermal protective shields must be installed.
- It is recommended that the protective window is cleaned from time to time with a soft alcohol-soaked cloth or cotton pad.

10.5.3 Delivery

The rotatable plug-nipple glands type LCKN-1/8-PK-6 (FESTO) for the compressed-air tubes with a inner diameter of 6 mm, the air plate (SGHF) and the sensor fastening accessories are included in the delivery of the protective housing.

- **I** The protection class is limited to water (no penetrating liquids or similar).

SGH/SGHF size S

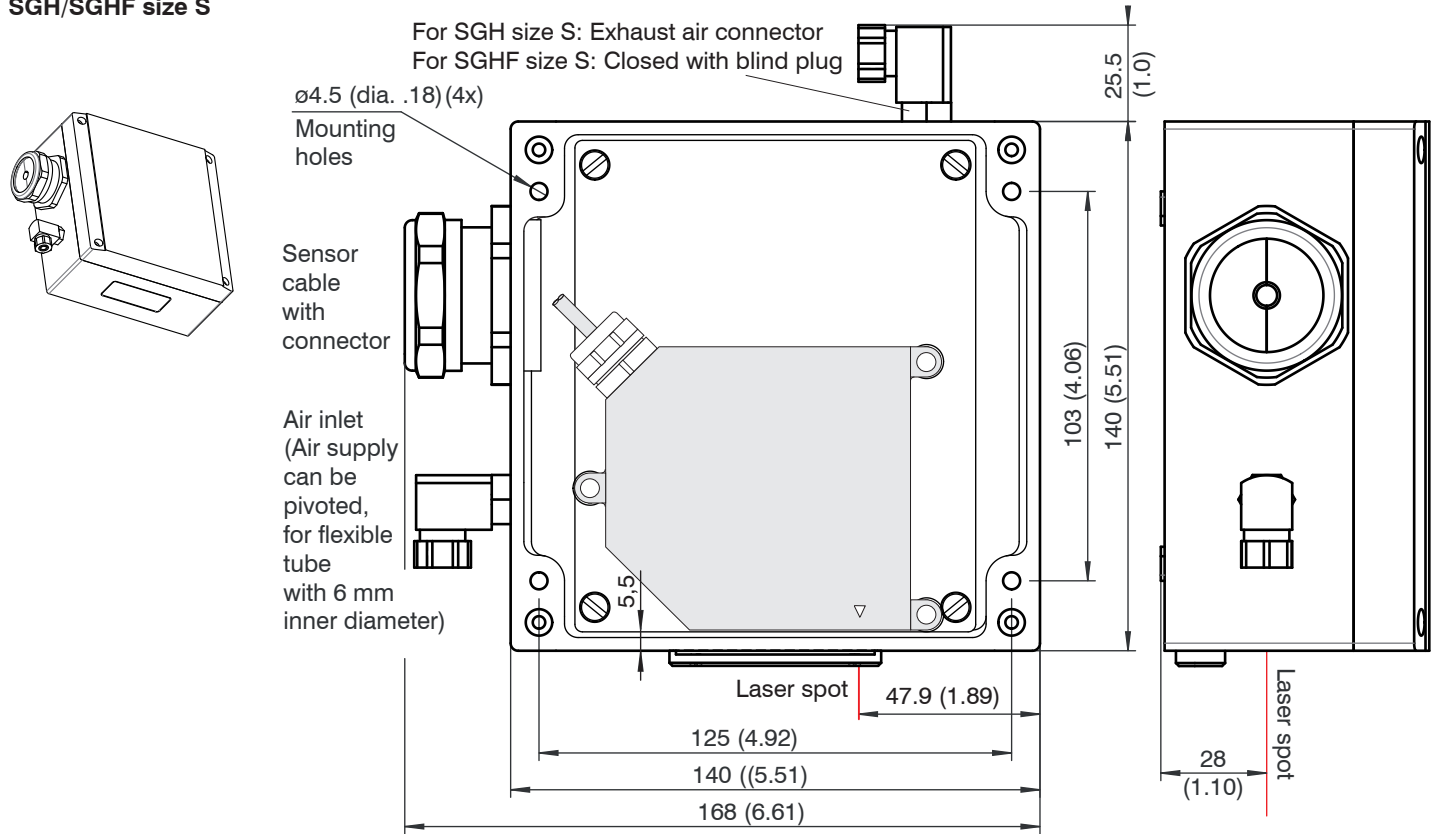

Fig. 55 Protective housing for measuring ranges 2/10/20/50/100 mm

SGH/SGHF size M

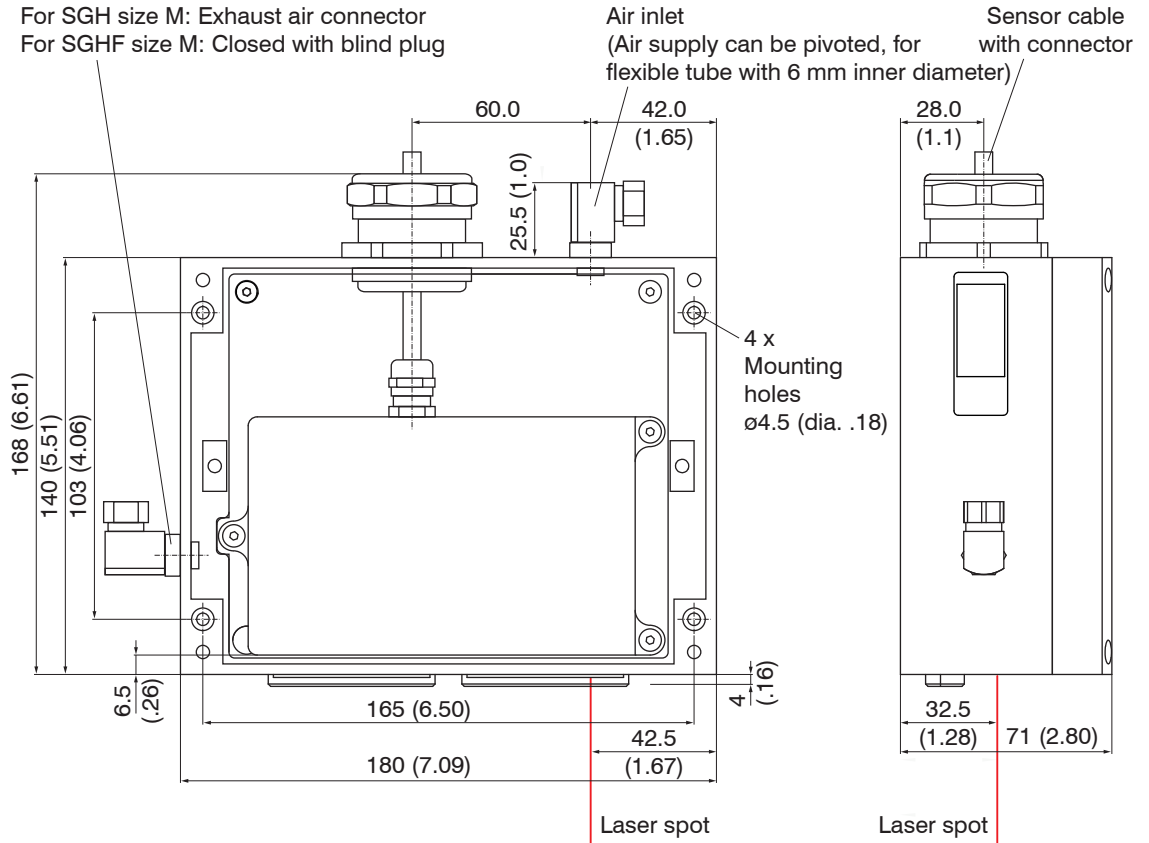
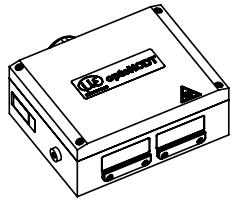

Fig. 56 Protective housing for measuring range 40 and 200 mm

11. RS422 Connection with USB Converter

Sensor 14-pin ODU connector	USB converter Typ USB-COMi-SI-M from MICRO-EPSILON		<p>Cross the lines for connections between sensor and PC.</p> <p>i Disconnect or connect the D-sub connection between RS422 and USB converter when the sensor is disconnected from power supply only.</p> <p><i>Fig. 57 Pin assignment and USB converter</i></p>
Tx + (Pin 9)	Rx + (Pin 3)		
Tx -(Pin 10)	Rx -(Pin 4)		
Rx + (Pin 7)	Tx + (Pin 2)		
Rx -(Pin 8)	Tx -(Pin 1)		
GND (Pin 2)	GND (Pin 5)		

12. Software Support with MEDAQLib

MEDAQLib offers you a documented driver DLL. Therewith you embed optoNCDT laser sensors, in combination with

- the RS422/USB converter, see Chap. A 1 or
- the 4-way converter IF2004/USB and connection cable PC2300-x/IF2008, see Chap. A 5 or
- the PCI interface card IF 2008 and the PC2300-x/IF2008 cable, see Chap. 8. or
- Ethernet cards

into an existing or a customized PC software.

MEDAQLib

- contains a DLL, which can be imported into C, C++, VB, Delphi and many additional programs,
- makes data conversion for you,
- works independent of the used interface type,
- features by identical functions for the communication (commands),
- provides a consistent transmission format for all MICRO-EPSILON sensors.

For C/C++ programmers MEDAQLib contains an additional header file and a library file. You will find the latest driver / program routine at:

www.micro-epsilon.de/download

www.micro-epsilon.de/link/software/medaqlib

13. Warranty

All components of the device have been checked and tested for perfect function in the factory. In the unlikely event that errors should occur despite our thorough quality control, this should be reported immediately to MICRO-EPSILON.

The warranty period lasts 12 months following the day of shipment. Defective parts, except wear parts, will be repaired or replaced free of charge within this period if you return the device free of cost to MICRO-EPSILON. This warranty does not apply to damage resulting from abuse of the equipment and devices, from forceful handling or installation of the devices or from repair or modifications performed by third parties.

No other claims, except as warranted, are accepted. The terms of the purchasing contract apply in full. MICRO-EPSILON will specifically not be responsible for eventual consequential damages. MICRO-EPSILON always strives to supply the customers with the finest and most advanced equipment. Development and refinement is therefore performed continuously and the right to design changes without prior notice is accordingly reserved. For translations in other languages, the data and statements in the German language operation manual are to be taken as authoritative.

14. Decommissioning, Disposal

 Disconnect the power supply and output cable on the sensor..

Incorrect disposal may cause harm to the environment.

 Dispose of the device, its components and accessories, as well as the packaging materials in compliance with the applicable country-specific waste treatment and disposal regulations of the region of use.

15. Service, Repair

In the event of a defect on the sensor or the sensor cable:

- If possible, save the current sensor settings in a parameter set, see Chap. 7.7.1, in order to load again the settings back into the sensor after the repair.
- Please send us the effected parts for repair or exchange.

In the case of faults the cause of which is not clearly identifiable, the whole measuring system must be sent back to

MICRO-EPSILON Optronic GmbH
 Lessingstraße 14
 01465 Langebrück / Germany
 Tel. +49 (0) 35201 / 729-0
 Fax +49 (0) 35201 / 729-90
 optronic@micro-epsilon.de
 www.micro-epsilon.com

Using the diagnostic file, see menu `Help/Info`, you can save the current sensor settings into a file. The diagnostics file effects the same result as the command `PRINT ALL`, see Chap. A 6.3.1.7

The screenshot shows the 'optoNCDT 2300' diagnostic interface. The top navigation bar includes buttons for 'Home', 'Preferences', 'Measurement', 'Videosegnal', and 'Help/Info'. The 'Help/Info' button is selected. The main content area is divided into two sections: 'Serial and version numbers' and 'Calibration tables'. The 'Serial and version numbers' section contains a table with the following data:

Serial number:	12030062
Option:	000
MAC address:	00-0C-12-01-0A-64
Software version:	009.097.125
Image:	User

The 'Calibration tables' section contains a table with the following data:

Nr.	Typ	Measuring range
1:	DIFFUSE	20.00 mm
2:	DIRECT	20.00 mm

Below the tables is a 'Note' section with the following text:

Note:
 Please save a copy of the setup-file on your PC or laptop before shipping the sensor for repair or service reasons to Micro-Epsilon. The setup-file can be found in the download folder of your browser.
 For support a diagnostic file can be sent to the manufacturer. Please attach a detailed description of the fault, a photo or a drawing of the measurement setup, and stored mesurement values, if possible.

At the bottom of the interface is a button labeled 'Save diagnostic file'.

Appendix

A 1 Optional Accessories

PC2300-x/SUB-D



Power supply and output cable, x = length in m, drag chain suitable (x = 3, 6 or 9 m), for the supply with 24 VDC, signals: Ethernet, Ethercat, RS422, synchronization, laser on/off and limit switches

PC2300-x/CSP







Interface and power supply cable for connection to a controller CSP2008, cable length x = 3 or 10 m

PC2300-x/IF2008

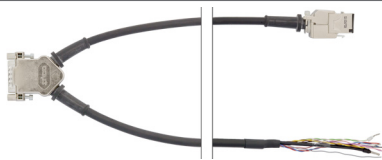

Interface and power supply cable for connection to an interface card IF2008 or the 4-way converter IF2004/USB, cable length x = 3 or 6 m

PC2300-0.5/Y		Power supply and output cable, 0.5 m long, for Ethernet connection and open ends
PC2300-x/OE		Power supply and output cable with open ends, cable length $x = 3, 6$ or 9 m
RS422/USB converter		Converter RS422 to USB, type USB-COMi-SI-M, useable for cable PC2300-0.5/Y or PC2300-x/OE, inclusive driver, connections: 1 × Sub-D, 1 × terminal block
IF2001/USB		Converter RS422 to USB, type IF2001/USB, useable for cable PC2300-X/OE or PC2300-X/SUB-D + PC2300-0,5/Y, inclusive driver, connections: 1 × female connector 10-pin (cable clamp) type Würth 691361100010, 1x female connector 6-pin (cable clamp) type Würth 691361100006
IF2004/USB		4 channel converter RS422 to USB useable for cable PCxx00-x/IF2008 or PC2300-0.5/Y, inclusive driver, connections: 2 × Sub-D, 1 × terminal block

PS2020



Power supply for mounting on DIN rail, input 230 VAC, output 24 VDC/2.5 A

IF2008

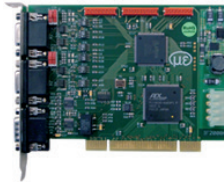

The IF2008 interface card enables the synchronous capture of 4 digital sensor signals series optoNCDT 2300 or others or 2 encoders. In combination with IF2008E a total of 6 digital signals, 2 encoder, 2 analog signals and 8 I/O signals can be acquired synchronously.

IF2008-Y adapter cable



Used to connect two sensors with interface cable PC2300-x/IF2008 to a port of the IF2008.

Level converter
SU4-1
Level converter
SU4-2



Signal converter, 3 channels HTL on RS422,
Signal converter, 3 channels TTL on RS422
for trigger signal sources

C-Box



Processing of 2 digital input signals. D/A converter of one digital measurement, output via current and voltage interface.

Assembly aid	Stock No.	Sensor	Aluminum device for easy mounting of a sensor in direct reflection.
ILD1700/2300, 20,5°	0585014	ILD2300-2	
ILD1700/2300, 20,0°	0585011	ILD2300-5 und -5BL	
ILD1700/2300, 13,8°	0585016	ILD2300-20	
ILD1700/2300, 17,5°	0585015	ILD2300-10	

A 2 Factory Setting**A 2.1 Parameters**

Parameter	Value 1	Value 2
Password	„000“	
Measuring program	Diffuse reflection	Highest peak
Measuring rate	20 kHz	
Video averaging	none	
Measurement averaging	Median 9	
Error handling	Hold last value	200
Statistics	All measured values	
Selection digital interface	Web diagram	
Data selection	Distance	
Ethernet	Static IP address	169.254.168.150
RS422	691.200 kBaud	
Output data rate	1	
Trigger mode	No trigger	
Synchronization	No synchronization	
Language	German	

A 2.2 Set Default Settings

Used hardware:

- PC2300-x/Sub-D
- PC2300-0,5/Y
- RJ45 short-circuit plug

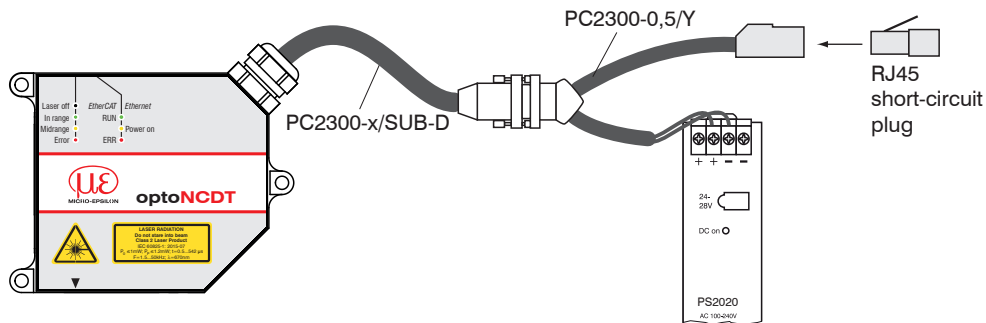

Fig. 58 Default setting with a RJ45 short-circuit plug

Prerequisite: The supply voltage to the sensor is off.

Proceeding:

- ➡ Connect the RJ45 short-circuit plug on the PC2300-0,5/Y cable, see Fig. 58.
- ➡ Switch on the supply voltage to the sensor.
- ➡ Wait until to the end of the boot process in the sensor.

Booting finished	LED Ethernet/EtherCAT	yellow
	LED State	any

- ➡ Remove the RJ45 short-circuit plug.

i Resetting the sensor to factory settings with a RJ45 short-circuit plug is possible for sensors that are shipped with a software version $\geq 009.xxx.yyy$.

A 3 PC2300-0.5/Y

The PC2300-0.5/Y cable splits the sensor signals to an RJ45 female connector (Ethernet) and a cable with open leads. Cable length is 0.5 m.

Signal	15-pin Sub-D connector	Open leads	RJ45 connector	
+ U _b	1	white		
GND	9	brown		
+ Laser on/off	2 ¹	green		
- Laser on/off	10 ¹	yellow		
Sync-in/out	3	grey		
/Sync-in/out	11	pink		
RxD-RS422	4	blue		
/RxD-RS422	12	red		
TxD-RS422	5	black		
/TxD-RS422	13	violet		
Shield	Housing	Cable screen		
Tx - Ethernet	6		1	
/Tx - Ethernet	14		2	
Rx - Ethernet	7		3	
/Rx - Ethernet	15		6	
Shield	Housing		Housing	

Cable shield is provided with a ferrule. The strands of RS422 and synchronization are cut blunt.

1) +U_b and +Laser on/off are connected together. GND and –Laser on/off are connected together.

A 4 PC2300-x/OE

The PC2300-x/OE cable contains a 14-pin ODU round connector and open leads.
Cable length x in meters.

Signal	14-pin ODU		Open leads
+ U _b	1		
Masse	2 (advanced)		brown
+ Laser on/off	3		green
- Laser on/off	4		yellow
Sync-in/out	5		grey
/Sync-in/out	6		pink
RxD-RS422	7		blue
/RxD-RS422	8		red
TxD-RS422	9		black
/TxD-RS422	10		violet
Tx - Ethernet	11		grey-pink
/Tx - Ethernet	12		red-blue
Rx - Ethernet	13		white-green
/Rx - Ethernet	14		brown-green
Shield	Housing	Sensor round pin plug, view: Solder-pin side male cable connector	Cable shield

Cable shield is provided with a ferrule, others are cut blunt.

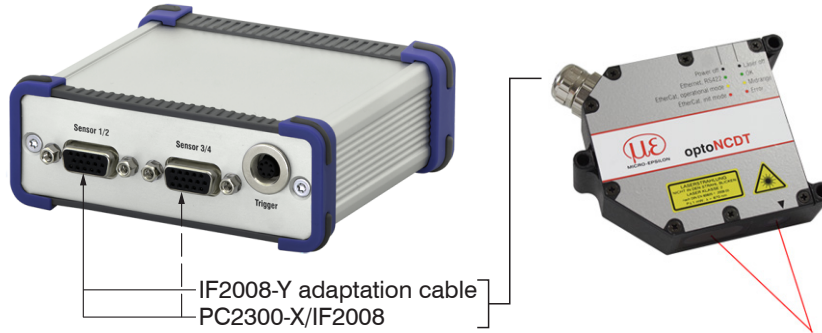
A 5 IF2004/USB

The 4-channel RS422/USB converter with trigger input is designed for one to four optical sensors with RS422 interface. The data is output through the USB interface. The sensors are supplied through the converter.

A 6 ASCII Communication with Sensor

A 6.1 General

The ASCII commands can be sent to the sensor via the RS422 interface or Ethernet.

All commands, inputs and error messages are effected in English.

One command always consists of a command name and zero or several parameters, which are separated by blanks and are completed with LF. If blanks are used in parameters, the parameter must be set in quotation marks.

Example: Switch on the output via RS422

OUTPUT RS422 ←↵

Advice: ←↵ must include LF, but may also be CR LF.

Declaration: LF Line feed (line feed, hex 0A)

CR Carriage return (carriage return, hex 0D)

←↵ Enter (depending on the system System hex 0A or hex 0D0A)

The currently set parameter value is returned, if a command is activated without parameters.

The input formats are:

```
<Command name> <Parameter1> [<Parameter2> [...]]
```

```
<Command name> <Parameter1> <Parameter2> ... <Parameter...>
```

or a combination thereof.

Parameters in []-brackets are optional and require the input of the parameter standing in front. Sequent parameters without []-brackets are to input compulsory, that is, it must not be omitted a parameter.

Alternative inputs of parameter values are displayed separately by „|“, for example the values „a“, „b“ or „c“ can be set for “a|b|c”.

Parameter values in <> brackets are selectable from a value range.

Declarations on format:

„a b“	Value of the parameter can be set to the value “a” or “b”.
„ P1 P2“	It requires that both parameters “P1” and “P2” are set.

„ P1 [P2 [P3]]“	The parameters “P1“, “P2“ and “P3“ can be set, whereby “P2“ may only be set, if “P1“ is set and “P3“ only if “P1“ and “P2“ are set.
„<a>“	The value of the parameter lies in a value range of “... to ...“, see parameter description.

Parameter values without peak brackets can only assume discrete values, see parameter description.

Parantheses are to be understood as a grouping, that is, for a better articulation „P1 P2 | P3“ is written as „(P1 P2) | P3“.

Example with []:

„IPCONFIG DHCP|STATIC [<IPAddress> [<Netmask> [<Gateway>]]“

- The 1. parameter can be set to the value „ DHCP“ or “STATIC“.
- Additionally the parameters „IPAddress“, „netmask“ and „gateway“ can be assigned at STATIC.
- The parameter „IPAddress“, „netmask“ and „gateway“ can only be set, if the parameter 1 is set, also the parameter „IPAddress“ is the requirement for entering the additional parameters „netmask“ and „gateway“; „netmask“ the requirement for entering the parameter „Gateway“.
- Example without []:

„PASSWD <Old password> <New password> <New password>“

- To change the password, all three parameters are to be input.

The output format is:

<Command name> <Parameter1> [<Parameter2> [...]]

The reply can be used again as command for the parameter setting without changes. Optional parameters are only returned, if the returning is necessary. For example, the activated output values are returned by command Data selection additional values, see Chap. [A 6.5.2.5](#). After processing a command always a return and a prompt (“-<“) is returned. In the case of an error an error message is before the prompt, that begins with „Exx“, where xx is a unique error number. Also warnings („Wxx“) can be output instead of error messages.

These are analogous to the error messages. In case of warnings the command is executed.

The replies to the commands GETINFO and PRINT are useful for support requests to the sensor, because they contain sensor settings.

A 6.2 Commands Overview

Group	Chapter	Command	Short info
General			
	Chap. A 6.3.1.2	GETINFO	Sensor information
	Chap. A 6.3.1.3	SYNC	Synchronization
	Chap. A 6.3.1.4	RESET	Booting the sensor
	Chap. A 6.3.1.5	RESETCNT	Reset counter
	Chap. A 6.3.1.5	ECHO	Switching the Command Reply, ASCII Interface
	Chap. A 6.3.1.7	PRINT	Print
User level			
	Chap. A 6.3.2.1	LOGIN	Change of user level
	Chap. A 6.3.2.2	LOGOUT	Change to user in the user level
	Chap. A 6.3.2.3	GETUSERLEVEL	User level request
	Chap. A 6.3.2.4	STDUSER	Set standard user
	Chap. A 6.3.2.5	PASSWD	Change password
Triggering			
	Chap. A 6.3.3.1	TRIGGER	Trigger selection
	Chap. A 6.3.3.2	TRIGGERAT	Effect of the Trigger Input
	Chap. A 6.3.3.3	TRIGGERLEVEL	Trigger level
	Chap. A 6.3.3.4	TRIGGERCOUNT	Number of measurement values displayed
	Chap. A 6.3.3.5	TRIGGERSW	Software - Trigger pulse
	Chap. A 6.3.3.6	TRIGGEROUT	Selection of output values with triggering

Interfaces		
Chap. A 6.3.4.1	IPCONFIG	Ethernet
Chap. A 6.3.4.2	MEASTRANSFER	Setting measurement server
Chap. A 6.3.4.3	BAUDRATE	Setting RS422
Chap. A 6.3.4.4	ETHERMODE	Change between Ethernet and EtherCAT
Chap. A 6.3.4.5	UNIT	Change units in the web-interface
Loading / saving settings		
Chap. A 6.3.5.1	STORE	Save parameter
Chap. A 6.3.5.2	READ	Load parameter
Chap. A 6.3.5.2	SETDEFAULT	Default settings

Measurement		
General		
Chap. A 6.4.1.1	MEASMODE	Measurement mode
Chap. A 6.4.1.2	MEASPEAK	Selection of peak for distance measurement
Chap. A 6.4.1.3	GETVIDEO	Video signal request
Chap. A 6.4.1.4	MEASRATE	Measuring rate
Chap. A 6.4.1.5	LASERPOW	Laser power
Video signal		
Chap. A 6.4.2.1	ROI	Reduction of region of interest (ROI)
Chap. A 6.4.2.2	VSAVERAGE	Video averaging
Material data base		
Chap. A 6.4.3.1	MATERIALTABLE	Reading of material database
Chap. A 6.4.3.2	MATERIAL	Choose material
Chap. A 6.4.3.3	MATERIALINFO	Display material
Chap. A 6.4.3.4	MATERIALEDIT	Edit material table
Chap. A 6.4.3.5	MATERIALDELETE	Delete material table
Measurement value processing		
Chap. A 6.4.4.1	AVERAGE	Averaging of measurement value
Chap. A 6.4.4.2	SPIKECORR	Spike correction
Chap. A 6.4.4.3	STATISTICDEPTH	Values used for statistics
Chap. A 6.4.4.4	RESETSTATISTIC	Reset the statistics
Chap. A 6.4.4.5	MASTERMV	Setting masters / zero

Data output		
General		
Chap. A 6.5.1.1	OUTPUT	Selection digital output
Chap. A 6.5.1.2	OUTREDUCE	Output data rate
Chap. A 6.5.1.3	OUTHOLD	Error processing
Chap. A 6.5.1.4	GETVALUE	Specified measured value output
Select measurement values to be output		
Chap. A 6.5.2.1	GETOUTINFO_ETH/422	Request Data Selection
Chap. A 6.5.2.2	OUTDIST_RS422	Data selection displacement measurement
Chap. A 6.5.2.3	OUTTHICK_RS422	Data selection thickness measurement
Chap. A 6.5.2.4	OUTSTATISTIC_RS422 OUTSTATISTIC_ETH	Data selection statistic values
Chap. A 6.5.2.5	OUTADD_RS422 OUTADD_ETH	Data selection optional values
Chap. A 6.5.2.6	OUTVIDEO	Set video output

A 6.3 General Commands

A 6.3.1 General

A 6.3.1.1 Help

```
HELP [<Befehl>]
```

Issues a help for every command. If no command is specified a general help is output.

A 6.3.1.2 Sensor Information

```
GETINFO
```

Request of sensor information. Output see example below:

```
->GETINFO
Name:          ILD2300
Serial:        10110002
Option:        000
Article:       4120178
MAC-Address:   00-0C-12-01-03-04
Measuring range: 20.00mm
Name CalTab:   DIFFUSE
Version:       0003.066.087
Imagetype:     User
->
```

Name: Model name of sensor / of sensor series

Serial: Serial number of sensor

Option: Optional number of sensor

Article: Order number of sensor

MAC-Address: Address of network adapter

Measuring range: Measuring range of sensor

Name CalTab: Loaded correction table

Version: Version of booted software

Imagetype: User --> After update by the user; factory --> delivery status

A 6.3.1.3 Synchronization

SYNC NONE | SLAVE | MASTER | MASTER_ALT TERMON | TERMOFF

Setup of type of synchronization.

- NONE: No synchronization
- SLAVE: Sensor is slave and expects the synchronous pulses of a different optoNCDT 2300.
- MASTER: Sensor is master, that is, it outputs the synchronization pulses.
- MASTER_ALT: Sensor is master, that is, it outputs the synchronization pulses with every second image. Both sensors measure alternately, for example, thickness measurement with two sensors on transparent material.

Setting the timing of synchronous / trigger input:

- TERMON: Timing (type 120 OHM)
- TERMOFF: No timing

The SYNC command always expects two parameters. In the operation modes MASTER and MASTER_ALT the second parameter is not evaluated.

As an alternative the synchronization connections are inputs or outputs, that is, it is important, that only one of the sensors is switched on master and the other/ the others is/ are switched on slave. In addition, the synchronous input is also used as a trigger input for the edge and level triggering, see Chap. [7.6.1](#).

A 6.3.1.4 Booting the Sensor

RESET

The sensor is restarted.

A 6.3.1.5 Reset Counter

RESETCNT [TIMESTAMP] [MEASCNT] [TRIGCNT]

After the selected trigger edge comes into effect, the counter is reset.

- **TIMESTAMP**: resets the time stamp
- **MEASCNT**: resets the measurement value counter
- **TRIGCNT**: resets the trigger counter (after every 32 bit)

For the trigger modes `NONE` and `SOFTWARE`, the function for resetting the counters in the sensor comes into effect immediately after the received command has been decoded. It is therefore not possible to establish temporal references between several sensors or to have the counters in several sensors start simultaneously.

If `EDGE` or `PULSE` is selected as trigger type, the reset comes into effect with the next edge of the trigger signal.

A 6.3.1.6 Switching the Command Reply, ASCII Interface

ECHO ON|OFF

Setting the command reply at an ASCII command:

- **ON**: Command reply on, for example `<Kdo> ok`
->
- **OFF**: Command reply off, for example `->`

A 6.3.1.7 PRINT

Print

Print serves the output of all sensor settings.

Example of an answer:

```
GETUSERLEVEL USER                                OUTDIST_RS422 DIST1
STDUSER PROFESSIONAL                            OUTTHICK_RS422 NONE
TRIGGER NONE TERMOFF                            OUTADD_ETH NONE
TRIGGERLEVEL LOW                                OUTADD_RS422 NONE
TRIGGERCOUNT 1                                OUTSTATISTIC_ETH NONE
SYNC NONE TERMOFF                               OUTSTATISTIC_RS422 NONE
IPCONFIG STATIC 169.254.168.150 255.255.255.0 169.254.168.1
MEASTRANSFER SERVER/TCP 1024
BAUDRATE 115200
MEASPEAK DISTA
MEASMODE DIST_DIFFUSE
MEASRATE 20
MATERIAL Vacuum
LASERPOW FULL
ROI 0 511
VSAVERAGE NONE
OUTVIDEO NONE
AVERAGE MEDIAN 9
MASTERMV NONE
STATISTICDEPTH ALL
OUTPUT NONE
OUTREDUCE 1 RS422 ETHERNET
OUTHOLD 200
```

A 6.3.2 User Level

A 6.3.2.1 Change of the User Level

```
LOGIN <Password>
```

Enter password to change user level. The following user levels are available:

- USER (Standard user): “Read-only” access for all elements and graphical display of output values of web surface
- PROFESSIONAL (Expert): “Read-only” and “Write” access for all elements

A 6.3.2.2 Change to User in the User Level

```
LOGOUT
```

Set user level to USER.

A 6.3.2.3 User Level Request

```
GETUSERLEVEL
```

Request current user level

A 6.3.2.4 Set Standard User

```
STDUSER USER | PROFESSIONAL
```

Set standard user who is automatically logged in after system start. Standard user does not change with LOGOUT, which means login as standard user is done automatically after the command RESET or power supply of sensor is switched.

A 6.3.2.5 Change Password

```
PASSWD <Old Password> <New Password> <New Password>
```

Change password for user level PROFESSIONAL.

Type in old password followed by the new password (2x). In case the new password is not typed in correctly, error message will be displayed. Password may only contain letters from A to Z, no numbers 0 to 9. Watch upper and lower case lettering. The maximum length is limited to 31 characters.

A 6.3.3 Triggering

Trigger-input serves also as synchronous input, which means level and edge triggering is only alternatively possible to sync mode, see Chap. 7.6.3 (Synchronization).

A 6.3.3.1 Trigger Selection

```
TRIGGER NONE | EDGE | PULSE | SOFTWARE TERMON | TERMOFF
```

- NONE: No triggering
- PULSE: Level triggering
- EDGE: Edge triggering
- SOFTWARE: Software triggering

Set timing for sync- / trigger-input:

- TERMON: Timing (type 120 OHM)
- TERMOFF: No timing

The TRIGGER command always expects two parameters. If software triggering is used, the second parameter is not evaluated.

A 6.3.3.2 Effect of the Trigger Input

```
TRIGGERAT [INPUT | OUTPUT]
```

- INPUT: Triggers the measurement value recording. Measurement values immediately before the trigger event are not included when calculating the mean value. Instead, older values are used which were output during previous trigger events.
- OUTPUT: Triggers the measurement value output. Measurement values immediately before the trigger event are included when calculating the mean.

A 6.3.3.3 Trigger Level

```
TRIGGERLEVEL HIGH | LOW
```

- HIGH: Edge triggering: Rising edge, level triggering: High-active
- LOW: Edge triggering: Falling edge, level triggering: Low-active

A 6.3.3.4 Number of Measurement Values Displayed

TRIGGERCOUNT <1...16382>|16383

- 1...16382: Number of measurement values which are displayed after trigger impulse when edge triggering or software triggering.
- 16383: Start continuous output of measurement values after trigger impulse when edge triggering or software triggering.
- 0: Stop triggering and discontinue continuous output of measurement values.

A 6.3.3.5 Software Trigger Pulse

TRIGGERSW

Creates a trigger pulse. Error message is displayed if "SOFTWARE" is not selected in trigger selection.

A 6.3.3.6 Trigger Output all Values

TRIGGEROUT [TRIGGERED|ALL]

- TRIGGERED: Factory setting; measurements output only, if the trigger is active.
- ALL: all measurements are output; Identification in bit 15 of the status word

A 6.3.4 Interfaces

A 6.3.4.1 Ethernet

```
IPCONFIG DHCP|STATIC [<IP address> [<Netmask> [<Gateway>]]]
```

Set Ethernet interface.

- DHCP: IP address and gateway are automatically requested by DHCP. System looks for a LinkLocal address after appr. 30 seconds if no DHCP server is available.
- STATIC: Set IP address, net mask, and gateway in format xxx.xxx.xxx.xxx

Values stay the same if no IP address, net mask, and gateway is typed in.

A 6.3.4.2 Setting Measurement Server

```
MEASTRANSFER NONE|SERVER/TCP [<PORT>] | (CLIENT/TCP|CLIENT/UDP [<IP address> [<Port>]])
```

The ILD 2300 can be operated as a server as well as a client for measurement output via Ethernet.

- None: No measurement transmission via Ethernet.
- SERVER/TCP: Sensor provides a server for the typed in port, under which the measured values can be sent. This is only possible via TCP/IP.
- CLIENT/TCP: Sensor sends measured values via TCP/IP connection oriented to server.
- CLIENT/UDP: Sensor sends measured values via UDP/IP to server. Therefore the IP address and port on the server are specified.
- IPAddress: IP address of the server, to which measured values are sent when in client-mode, (only valid for CLIENT/TCP or CLIENT/UDP)
- Port: Port, to which the server gets assigned to in server-mode or to which the measured values are sent in client-mode (min: 1024, max: 65535)

A 6.3.4.3 Setting RS422

```
BAUDRATE 9600|115200|230400|460800|691200|921600|1500000|2000000|2500000|3000000|3500000|4000000
```

Set the baud rate for the RS422 interface.

A 6.3.4.4 Change between Ethernet / EtherCAT

```
ETHERMODE ETHERNET|ETHERCAT
```

Switches between Ethernet and EtherCat.

A 6.3.4.5 Units Web-Interface

```
UNIT MM|INCH
```

Change the measurement display on the web pages. The command has no effect on the ASCII interface.

- MM representation in mm
- INCH representation in customs

A 6.3.5 Load / Save Settings**A 6.3.5.1 Save Parameter**

```
STORE 1|2|3|4|5|6|7|8
```

Stores current parameters of internal sensor RAM into the chosen number of internal sensor flash.

A 6.3.5.2 Load Parameter

```
READ ALL|DEVICE|MEAS 1|2|3|4|5|6|7|8
```

Loads parameter into internal sensor RAM from the chosen number of internal sensor flash. In addition, the size of the loaded data needs to be specified.

- ALL: All parameters are loaded.
- DEVICE: Only the standard device settings are loaded (interface parameter)
- MEAS: Only the measurement settings are loaded (all features for the measurement)

A 6.3.5.3 Default Settings

```
SETDEFAULT ALL|NODEVICE|MATERIAL
```

Sets sensor back to default settings.

- ALL: All setups are deleted and default parameters are loaded. In addition, the current material table is overwritten by standard material table.
- NODEVICE: All setups are deleted and default parameters are loaded. Settings of IP address and RS422 are kept temporarily.
- MATERIAL: Current material table is overwritten by standard material table.

A 6.4 Measurement**A 6.4.1 General****A 6.4.1.1 Measurement Mode**

```
MEASMODE DIST_DIFFUSE|DIST_DIRECT|THICKNESS|VIDEO
```

- DIST_DIFFUSE: Displacement measurement in diffuse reflection; peak selection, see Chap. [A 6.4.1.2](#)
- DIST_DIRECT: Displacement measurement in direct reflection; peak selection, see Chap. [A 6.4.1.2](#).
- THICKNESS: Thickness measurement
- VIDEO: Video transmission. Only the activated video data is transferred, no measurement values. Video images must be requested through individual command, see Chap. [A 6.5.2.6](#).

When selecting “DIST_DIRECT“ and/or „THICKNESS“ direct reflection mode must be activated so the sensor can switch over to proper correction table. As a result, necessary corrections of measurement signal in direct reflection are done.

When selecting thickness measurement program, thickness 1, 2 and peak 1 and 2 are automatically chosen via Ethernet interface for measurement value output. In measurement output via RS422 only the thickness is automatically output, the selection of 1st and 2nd peak is possible by means of OUTDIST_RS422.

A 6.4.1.2 Selection of Peak for Displacement Measurement

```
MEASPEAK DISTA | DISTW | DIST1
```

- DISTA: Output of peak with highest amplitude (standard for diffuse reflection)
- DISTW: Output of peak with largest area
- DIST1: Output of displacement 1 (complies with backside fading out for diffuse reflection)

A 6.4.1.3 Video Signal Request

```
GETVIDEO
```

Request of video signal via Ethernet interface.

A 6.4.1.4 Measuring Rate

```
MEASRATE 1.5|2.5|5|10|20|30|49
```

Selection of measuring rate in kHz. At 49 kHz a damping of measurement range takes place.

A 6.4.1.5 Laser Power

LASERPOW FULL | REDUCED | OFF

- FULL: Laser power is set to 100 % (1 mW, recommended).
- REDUCED: Laser power is reduced to 10 %; for reflecting materials in direct reflection mode.
- OFF: Laser is switched off.

Switch over of laser power cannot be used for control purposes because switch over is done delayed with low-pass filter. Typically sensor power is set to 100 %, only on strong reflecting materials (e.g. mirror) a decrease in power is thoughtful.

A 6.4.2 Video Signal

A 6.4.2.1 Reduction of Region of Interest (ROI)

ROI <Start> <End>

Set region of interest. ROI for start and end is between 0 and 511. "Start" value is smaller than "End" value.

A 6.4.2.2 Video Averaging

VSAVERAGE NONE | REC2 | REC4 | REC8 | MOV2 | MOV3 | MOV4 | MED3

- NONE: No video signal averaging
- REC2, REC4, REC8: Recursive average value over 2, 4, or 8 video signals
- MOV2, MOV3, MOV4: Moving average value 2, 4, or 8 video signals
- MED3: Median over 3 video signals

A 6.4.3 Material Data Base**A 6.4.3.1 Reading of Material Data Base**

MATERIALTABLE

Command gives all in the sensor stored materials back.

```

->MATERIALTABLE
                                     Refraction index
Pos, Name,                           nF at 670nm,   Description
  0, Vakuum,                           1.000000,     Vakuum; air (approx.)
  1, Water,                             1.337121,
  2, Ethanol,                           1.361400,
  7, PC,                                1.599439,     Polycarbonate
  8, Quartz glass,                      1.463126,     Silicon dioxide, Fused Silica
  9, BK7,                               1.522380,     Crown glass
->

```

A 6.4.3.2 Choose Material

MATERIAL <Material name>

Change of material between displacement 1 and 2. Material name must be typed in with a blank. Command differentiates between upper and lower case lettering.

A 6.4.3.3 Display Material

MATERIALINFO

Command gives material characteristics back.

```

->MATERIALINFO
Name:                                BK7
Description:                          Crown glass
Refraction index nF at 486nm:         1.522380
->

```

A 6.4.3.4 Edit Material Table

```
MATERIALEDIT <Name> <Description> (nF)
```

Add or edit material.

- Name: Name of material
- Description: Description of material
- nF: refraction index nF at 670 nm (min: 1.0, max: 4)

The material table can contain a maximum of 20 materials.

A 6.4.3.5 Delete Material Table

```
MATERIALDELETE <Name>
```

Deletes material from material table.

A 6.4.4 Measurement Value Processing**A 6.4.4.1 Averaging of Measurement Value**

```
AVERAGE NONE|MOVING|RECURSIVE|MEDIAN [<Averaging depth>]
```

The averaging value always affects all to be output displacement and difference values.

- MOVING: Moving averaging value (averaging depth 2, 4, 8, 16, 32, 64 and 128 possible)
- RECURSIVE: Recursive averaging value (averaging depth 1 up to 32768 possible)
- MEDIAN: Median (averaging depth 3, 5, 7 and 9 possible)

A 6.4.4.2 Spike Correction

```
SPIKECORR [ON|OFF[[<Number of evaluated measured values>][[<Tolerance range in mm>][<Number of corrected values>]]]
```

Spike correction is not enabled in the factory default settings.

	Factory settings	Min	Max
Number of measured values evaluated	3	1	10
Tolerance range in mm	0.1000000	0.0000000	100.0000000
Number of corrected values	1	1	100

A 6.4.4.3 Values used for Statistics

```
STATISTICDEPTH 2|4|8|16|32|64|128|256|512|1024|2048|4096|8192|16384|ALL
```

- ALL: Statistics calculated over all values up to the command „RESETSTATISTIC“ is used.
- 2|4|...16384: Range for moving used to calculate the statistics.

A 6.4.4.4 Reset the Statistics

```
RESETSTATISTIC
```

Resets the statistical values.

A 6.4.4.5 Setting Masters / Zero

```
MASTERMV NONE|MASTER <Master value>
```

- NONE: Completes the mastering.
- MASTER: Set the current measurement value as a master value.
- Master value: Master value in millimeters; min: -2 * measurement value, max: +2 * measuring range.

In case of master value is 0, then the mastering has the same functionality as the zero setting.

The master command awaits the next measurement value a maximum of 2 seconds and masters it. If no measurement value is received within this time, for example, by external triggering, the command returns with the error “E32 Timeout“. The master value is processed with six decimal places. Note that the output value is limited to 18 bits during data output via the RS422 interface.

Calculation of a measurement value in mm from digital output:

$$x [\text{mm}] = \left(\text{digital}_{\text{OUT}} * \frac{1.02}{65520} - 0.51 \right) * \text{Measuring range} [\text{mm}]$$

A 6.5 Data Output**A 6.5.1 General****A 6.5.1.1 Selection Digital Output**

```
OUTPUT NONE | RS422 | ETHERNET
```

- NONE: No measurement value
- RS422: Output of measurement values via RS422
- ETHERNET: Output of measurement values via Ethernet

A 6.5.1.2 Output Data Rate

```
OUTREDUCE <Output reduction> [RS422 | ETHERNET | NONE]
```

Reduces the measurement value output for all available interfaces.

- 1: Output each measurement value
- 2 ... 3000000: Output of each n-th measurement value

A 6.5.1.3 Error Processing

```
OUTHOLD NONE | 0 | <Number>
```

Setting the behavior of the measurement value output in case of error.

- NONE: No holding the last measurement value, output of error value.
- 0: Infinite holding of the last measurement value.
- Number: Holding the last measurement value on the number of measuring cycles; then an error value (maximum of 1024) is output.

A 6.5.1.4 Specified Measured Value Output

```
GETVALUE NONE | <Number> | ALL
```

Sends a specified number of measurement value frame. The command works after the commands OUTREDUCE and TRIGGER. It is no storable parameter. All measurement value frames are always output after Power ON.

- NONE: No measurement value frames are output.
- 1...4294967294: Output of specified number of measurement value frames
- ALL: Continuous output of measurement value frames

A 6.5.2 Select Measurement Values to be Output

Setting the values to be output via the RS422 and Ethernet interface. The maximum output rate via the Ethernet interface depends on the number of output values.

A 6.5.2.1 Request Data Selection

```
GETOUTINFO_ETH  
GETOUTINFO_RS422
```

The commands list all selected output data for the interfaces Ethernet or RS422. The sequence shown corresponds to the output sequence.

A 6.5.2.2 Data Selection Displacement Measurement

```
OUTDIST_RS422 NONE | ([DIST1] [DIST2])
```

Setting, which displacement values are output through RS422.

- NONE: No output of a displacement
- DIST1: Output of displacement 1
- DIST2: Output of displacement 2 (only possible, if thickness measurement is selected, see [Chap. A 6.4.1.1](#))

It can also be output two displacements. If displacement measurement is selected for “MEASMODE”, the selected peak (see “MEASPEAK”) is output as displacement value for “DIST 1”.

If thickness measurement is selected for “MEASMODE”, “DIST 1” represents the displacement value for the 1st peak.

A 6.5.2.3 Data Selection Thickness Measurement

```
OUTTHICK_RS422 NONE | [THICK12]
```

Defines, which calculated layer thickness is output via RS422.

- NONE: No output of calculated layer thickness
- THICK12: Output of the layer thickness between displacement 1 and 2.

This command is available only in the *MEASMODE THICKNESS* setting.

A 6.5.2.4 Data Selection Statistic Values

```
OUTSTATISTIC_ETH NONE|([MIN] [MAX] [PEAK2PEAK])
```

```
OUTSTATISTIC_RS422 NONE|([MIN] [MAX] [PEAK2PEAK])
```

- NONE: No output of statistic values
- MIN: Output of the minimum
- MAX: Output of the maximum
- PEAK2PEAK: Output of peak to peak values

A 6.5.2.5 Data Selection Optional Values

```
OUTADD_ETH NONE|([SHUTTER] [COUNTER] [TIMESTAMP] [INTENSITY] [STATE] [TRIGCNT]
[TEMP])
```

```
OUTADD_RS422 NONE|([TEMP] [SHUTTER] [COUNTER] [TIMESTAMP] [INTENSITY] [STATE])
```

Defines the optional values to be transmitted.

- NONE: No output of further values
- SHUTTER: Output of the exposure time
- COUNTER: Output of the profile counter
- TIMESTAMP: Output of the time stamp
- INTENSITY: Parallel output of intensity and displacement
- STATE: Output of the state word
- TRIGCNT: Output trigger counter (with Ethernet only)
- TEMP: Output of the temperature in 0.25°C increments

Via Ethernet, more optional values can be out parallel.

A 6.5.2.6 Set Video Output

```
OUTVIDEO NONE|[RAW] [CORR]
```

Defines the the video data to be transmitted through Ethernet.

- NONE: No video signal
- RAW: Output of the unconditioned signal
- CORR: Output of the corrected signal

A 6.6 Example Command Sequence During Measurement Selection

RS422 interface	Ethernet interface	Content
MEASMODE		Selection: diffuse or direct reflection, displacement or thickness measurement, video signal or measurement output
MEASPEAK		Peak selection for displacement measurement
MEASRATE		Measuring rate (under consideration of reflectivity and movement of the target)
VSAVERAGE		Averaging of the video signal (under consideration of reflectivity structure and movement of the target)
AVERAGE		Averaging of the measurements (under consideration of reflectivity structure and movement of the target)
OUTPUT		Selection of the output channel
OUTREDUCE		Reduction of the output data rate (under consideration of the selected output channel/channel settings and processing bandwidth of the target system)
OUTHOLD		Output characteristic during measurement errors
OUTDIST_RS422		Selection of the displacement values to be output through the RS422 interface Selection is automatically determined by „MEASMODE“ and „MEASPEAK“ for the Ethernet interface
OUTTHICK_RS422		Selection of thickness output through RS422 interface Selection is automatically determined by „MEASMODE“ for the Ethernet interface
OUTSTATISTIC_RS422	OUTSTATISTIC_ETH	Selection of the statistic values to be output
OUTADD_RS422	OUTADD_ETH	Selection of the optional values to be output
	IPCONFIG	Ethernet interface settings
	MEASTRANSFER	Settings for data output through Ethernet interface
BAUDRATE		Baud rate settings for RS422 interface

A 6.7 Error Messages

If an error occurs with a command, then the error message is listed.

Error message	Description
E01 Unknown command	unknown command (rights to small to read).
E02 Wrong or unknown parameter type	A transmitted parameter has a wrong type or a wrong number of parameters were transmitted.
E03	not used
E04 I/O operation failed	Can not write data to the output channel.
E05 The entered command is too long to be processed.	The entered command with the parameters is too long (greater than 255 bytes).
E06 Access denied.	Login as expert is necessary.
E07 The answer is too long to be displayed by this interpreter.	Answer is too long
E08 Unknown parameter	unknown parameter
E09	not used
E10	not used
E11 The entered value is out of range or its format is invalid.	The parameter value is out of range of the value range.
E12 The info-data of the update are wrong.	For update only. The header of the update data contains an error.
E13 Error during the data transmission for the update.	For update only. Error during update data transmission.
E14 Timeout during the update	For update only: Timeout in the transfer of update data.
E15 Update file is too big.	For update only: The update data are too large.
E16	not used
E17 Processing aborted.	Upload data are too large. Process aborted.

Error message	Description
E18 A signal transfer is already active - please stop this.	A measurement value transmission is active. Stop the data transmission in order to execute the command.
E19 The file is not valid for this sensor.	The transferred parameter file is for a different sensor type.
E20 Invalid file type	Invalid Filetype (Setup file or material table).
E21 Versions do not match.	The versions do not match (Setup file or material table).
E22 Checksum invalid	Checksum invalid (Setup file or material table).
E23 The set of parameters does not exist.	The set of parameters does not exist.
E24 Selection of section invalid	The selection of section is invalid.
E25	not used
E26 No signals selected.	There were no measurement values selected for transmission.
E27 Invalid combination of signal parameters - please check measure mode and selected signals.	Invalid signal combination; please check measure mode and selected signals
E28 The entry already exists	The material already exists.
E29	not used
E30 Master value is out of range.	The master value is out of range.
E31 The name of material does not exist.	The name of material does not exist in the bill of materials.
E32 Timeout	Timeout during mastering.
E33 Wrong parameter count.	Too high or too small number of parameters.
E34 Sensor is uncalibrated.	The sensor is uncalibrated.
E35 Cannot start transfer of measurement data.	Measurement value output cannot boot.
(only adjustments)	
E36	not used

Error message	Description
E37 ROI left must be lower than right.	The value of the left side of ROI must be lower than the right value.
E38 Too much output values for RS422 enabled.	Too much output values for RS422 enabled.
E39	not used
E40 It is not possibility to use UDP/IP for measurement-server.	It is not possibility to use UDP/IP for measurement-server.
E41 The repeated input of new password is not the same.	Password and verification password do not match.
E42	not used
E43 Triggermode SOFTWARE disabled.	Software trigger is disabled.
E44 Material table is full.	Material table is full.
E45 No video signal now	No video signal now
E46 Unsupported character	An unsupported character was received.
E47 The selection of signals is denied in current measurement mode	The signal selection may not be changed in this measurement setup.
E48 Materialtable is empty	Material table is empty.
E49 Software triggering is not active	Software triggering is not enabled, no software trigger pulse can be triggered.
E50 The number and length of the objects to be mapped would exceed PDO length	
E51 Not exactly one measuring value for RS422 enabled (C-Box)	No or more measurements are enabled for RS422 aktiviert (C-Box)
E52 User level not available for this sensor	Please contact Micro-Epsilon

Warning	Description
W03 Mastering/zeroing is deactivated	
W05 EtherCAT will be activated after saving the settings and restarting the controller.	
W06 GetValue for the selected output interface is not effective	
W07 The measuring output has been adapted automatically	

A 7 EtherCAT

A 7.1 Generall

EtherCAT® is, from the Ethernet viewpoint, a single, large Ethernet station that transmits and receives Ethernet telegrams. Such an EtherCAT system consists of an EtherCAT master and up to 65535 EtherCAT slaves. The fast transmission of the measurements is an essential task of the EtherCAT interface.

Master and slaves communicate via a standard Ethernet wiring. On-the-fly processing hardware is used in each slave. The incoming Ethernet frames are directly processed by the hardware. Relevant data are extracted or added from the frame. The frame is subsequently forwarded to the next EtherCAT® slave device. The completely processed frame is sent back from the last slave device. Various protocols can be used in the application level. CANopen over EtherCAT technology (CoE) is supported here. In the CANopen protocol, an object tree with Service Data Objects (SDO) and Process Data Objects (PDO) is used to manage the data.

Further information can be obtained from ® Technology Group (www.ethercat.org) or Beckhoff GmbH, (www.beckhoff.com). MICRO-EPSILON Optronic has the Vendor ID 0x00000607 of the EtherCAT® Technology Group.

A 7.2 Preamble

A 7.2.1 Structure of EtherCAT®-Frames

The transfer of data occurs in Ethernet frames with a special Ether type (0x88A4). Such an EtherCAT® frame consists of one or several EtherCAT® telegrams, each of which is addressed to individual slaves / storage areas. The telegrams are either transmitted directly in the data area of the Ethernet frame or in the data area of the UDP datagram. An EtherCAT® telegram consists of an EtherCAT® header, the data area and the work counter (WC). The work counter is incremented by each addressed EtherCAT® slave that exchanged the corresponding data.

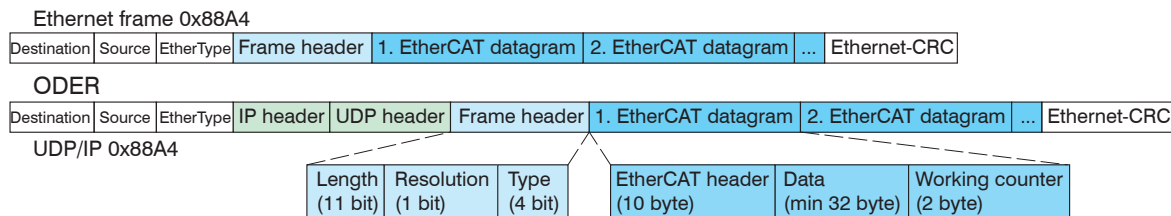

Fig. 59 Setup of EtherCAT frames

A 7.2.2 EtherCAT® Services

In EtherCAT® services for the reading and writing of data are specified in the physical memory of the slave hardware. The following EtherCAT® services are supported by the slave hardware:

- APRD (Autoincrement physical read, Reading of a physical area with auto-increment addressing)
- APWR (Autoincrement physical write, Writing of a physical area with auto-increment addressing)
- APRW (Autoincrement physical read write, Reading and writing of a physical area with auto-increment addressing)
- FPRD (Configured address read, Reading of a physical area with fixed addressing)
- FPWR (Configured address write, Writing of a physical area with fixed addressing)
- FPRW (Configured address read write, Reading and writing of a physical area with fixed addressing)
- BRD (Broadcast Read, Broadcast Reading of a physical area for all slaves)
- BWR (Broadcast Write, Broadcast Writing of a physical area for all slaves)
- LRD (Logical read, Reading of a logical storage area)
- LWR (Logical write, Writing of a logical storage area)
- LRW (Logical read write, Reading and writing of a logical storage area)
- ARMW (Auto increment physical read multiple write, Reading of a physical area with auto-increment addressing, multiple writing)
- FRMW (Configured address read multiple write, Reading of a physical area with fixed addressing, multiple writing)

A 7.2.3 Addressing and FMMUs

- In order to address a slave in the EtherCAT® system, various methods from the master can be used. The optoNCDT 2300 supports as full slave:
 - Position addressing
The slave device is addressed via its physical position in the EtherCAT® segment.
The services used for this are APRD, APWR, APRW.
 - Node addressing
The slave device is addressed via a configured node address, which was assigned by the master during the commissioning phase.
The services used for this are FPRD, FPWR and FPRW.
 - Logical addressing
The slaves are not addressed individually; instead, a segment of the segment-wide logical 4-GB address is addressed. This segment can be used by a number of slaves.
The services used for this are LRD, LWR and LRW.

The local assignment of physical slave memory addresses and logical segment-wide addresses is implemented via the field bus Memory Management Units (FMMUs). The configuration of the slave FMMUs is implemented by the master. The FMMU configuration contains a start address of the physical memory in the slave, a logical start address in the global address space, length and type of the data, as well as the direction (input or output) of the process data.

A 7.2.4 Sync Manager

Sync Managers serve the data consistency during the data exchange between EtherCAT® master and slaves. Each Sync Manager channel defines an area of the application memory. The optoNCDT2300 has four channels:

- Sync-Manager-Kanal 0: Sync Manager 0 is used for mailbox write transfers (mailbox from master to slave).
- Sync-Manager-Kanal 1: Sync Manager 1 is used for mailbox read transfers (mailbox from slave to master).
- Sync-Manager-Kanal 2: Sync Manager 2 is usually used for process output data. Not used in the sensor.
- Sync-Manager-Kanal 3: Sync Manager 3 is used for process input data. It contains the Tx PDOs that are specified by the PDO assignment object 0x1C13 (hex.).

A 7.2.5 EtherCAT State Machine

The EtherCAT® state machine is implemented in each EtherCAT®. Directly after switching on the op-toNCDT2300, the state machine is in the „Initialization“ state. In this state, the master has access to the DLL information register of the slave hardware. The mailbox is not yet initialized, i.e. communication with the application (sensor software) is not yet possible. During the transition to the pre-operational state, the Sync Manager channels are configured for the mailbox communication. In the „Pre-Operational“ state, communication via the mailbox is possible, and it can access the object directory and its objects. In this state, no process data communication occurs. During the transition to the „Safe-Operational“ state, the process-data mapping, the Sync Manager channel of the process inputs and the corresponding FMMU are configured by the master. Mailbox communication continues to be possible in the „Safe-Operational“ state. The process data communication runs for the inputs. The outputs are in the „safe“ state. In the „Operational“ state, process data communication runs for the inputs as well as the outputs.

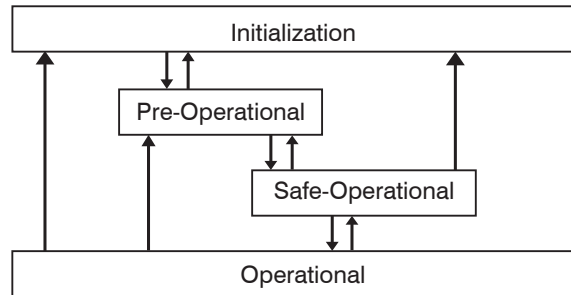

Fig. 60 EtherCAT State Machine

A 7.2.6 CANopen over EtherCAT

The application level communication protocol in EtherCAT is based on the communication profile CANopen DS 301 and is designated either as “CANopen over EtherCAT” or CoE. The protocol specifies the object directory in the sensor, as well as the communication objects for the exchange of process data and acyclic messages. The sensor uses the following message types:

- Process Data Object (PDO). The PDO is used for the cyclic I/O communication, therefore for process data.
- Service Data Object (SDO). The SDO is used for acyclic data transmission.

The object directory is described in the chapter CoE Object Directory.

A 7.2.7 Process Data PDO Mapping

Process Data Objects (PDOs) are used for the exchange of time-critical process data between master and slaves. Tx PDOs are used for the transmission of data from the slaves to the master (inputs), Rx PDOs are used to transmit data from the master to the slaves (outputs); not used in the optoNCDT2300. The PDO mapping defines which application objects (measurement data) are transmitted into a PDO. The optoNCDT2300 has a Tx PDO for the measuring data.

The following measurements are available as process data:

Designation	Description
Shutter time	Exposure time (32 bits)
Value counter	Measured value counter (32 bits)
Timestamp	Timestamp (32 bits)
Intensity 1	Intensity 1
Distance 1 (default)	Distance 1
Intensity 2	Intensity 2
Distance 2 (default)	Distance 2
Status	Status
Difference 1-2	Difference 1-2 (thickness)
Statistic minimum value	Statistical value (minimum)
Statistic maximum value	Statistical value (maximum)
Statistic peak-peak value	Statistical value (peak to peak)

Fig. 61 Measurements of the ILD2300

In EtherCAT the PDOs are transported in objects of the Sync Manager channel. The sensor uses the Sync Manager channel SM3 for input data (Tx data). The PDO assignments of the Sync Manager can only be changed in the “Pre-Operational” state. The mapping in the optoNCNT2300 is not carried out directly in the object 0x1A00, but rather by switching on and off individual measurements in the application object 0x21B0. The mapping result is available to the master after reloading the object directory.

Note: Subindex 0h of the object 0x1A00 contains the number of valid entries within the mapping report. This number also represents the number of application variables (parameters) that should be transmitted/received with the corresponding PDO. The sub-indices from 1h up to the number of objects contain information about the depicted application variables. The mapping values in the CANopen objects are coded in hexadecimal form.

The following table contains an example of the entry structure of the PDO mapping:

MSB		LSB	
31	16	15	8 7 0
Index e.g. 0x6064 (16 bits)		Subindex e.g. 0x02	
Object length in bits, e.g. 20h = 32 bits			

Fig. 62 Input structure of the PDO mapping, example

The fast transmission of the measurements is an important task of the EtherCAT interface.

When error “Invalid sync manager configuration” the PDO configuration is incorrect.

A 7.2.8 Service Data SDO Service

Service Data Objects (SDOs) are primarily used for the transmission of data that are not time critical, e.g. parameter values. EtherCAT specifies the SDO services as well as the SDO information services: SDO services make possible the read/write access to entries in the CoE object directory of the device. SDO information services make it possible to read the object directory itself and to access the properties of the objects. All parameters of the measuring device can be read or changed in this way, or measurements can be transmitted. A desired parameter is addressed via index and subindex within the object directory.

A 7.3 CoE – Object Directory

A 7.3.1 Characteristics

The CoE object directory (CANopen over EtherCAT) contains all the configuration data of the sensor.

The objects in CoE object directory can be accessed using the SDO services. Each object is addressed using a 16-bit index.

A 7.3.2 Communication Specific Standard Objects (CiA DS-301)

Overview		
Index (h)	Name	Description
1000	Device type	Device type
1001	Error register	Error register
1003	Error history	Predefined error field
1008	Device name	Manufacturer device name
1009	Hardware version	Hardware version
100A	Software version	Software version
1018	Identify	Device identification
1A00	Sample 0	TxPDO Mapping
1A01	Sample 1	TxPDO Mapping (for oversampling)
...	...	
1A63	Sample 99	
1C00	Sync. manager type	Sync. manager type
1C13	TxPDO assign	TxPDO assign
1C33	SM-input parameter	Sync. parameter (Switching FreeRun CD)

A 7.3.2.1 Object 1000h: Device type

1000	VAR	Device type	0x00200000	Unsigned32	ro
------	-----	-------------	------------	------------	----

Provides informations about the used device profile and the device type.

A 7.3.2.2 Object 1001h: Error register

1001	VAR	Error register	0x00	Unsigned8	ro
------	-----	----------------	------	-----------	----

The error register contains generic informations about the kind of the internally adjacent device errors. The general error bit is set on each case.

Structure of error register

7	6	5	4	3	2	1	0
Manufacturer	Reserved	Reserved	Reserved	Reserved	Reserved	Reserved	General

A 7.3.2.3 Object 1003h: Predefined error field

1003	RECORD	Error history			
------	--------	---------------	--	--	--

Subindices

0	VAR	Number of entries	1	Unsigned8	rw
1	VAR			Unsigned32	ro

The occurring device errors are registered here. The last error is saved in the error field. The entry under Sub-Index 0 contains the number of saved errors, by writing the value 0, the errors are eliminated.

A 7.3.2.4 Object 1008h: Manufacturer device name

1008	VAR	Device name	ILD2300	Visible String	ro
------	-----	-------------	---------	----------------	----

A 7.3.2.5 Object 1009h: Hardware version

1009	VAR	Hardware version	V x.xxx	Visible String	ro
------	-----	------------------	---------	----------------	----

A 7.3.2.6 Object 100Ah: Software version

100A	VAR	Software version	V x.xxx	Visible String	ro
------	-----	------------------	---------	----------------	----

A 7.3.2.7 Object 1018h: Device identification

1018	RECORD	Identity			
------	--------	----------	--	--	--

Subindices

0	VAR	Number of entries	4	Unsigned8	ro
1	VAR	Vendor ID	0x00000607	Unsigned32	ro
2	VAR	Product code	0x003EDE73	Unsigned32	ro
3	VAR	Revision	0x00010000	Unsigned32	ro
4	VAR	Serial number	0x009A4435	Unsigned32	ro

The article number is deposit in the product code, the serial number of the sensor in serial number.

A 7.3.2.8 Object 1A00h: TxPDO Mapping

1A00	RECORD	TxPDO Mapping			
------	--------	---------------	--	--	--

Subindices

0	VAR	Anzahl Einträge	13		
1	VAR	Shutter time	0x60650120	Unsigned8	ro
2	VAR	Value counter	0x60650220	Unsigned32	ro
3	VAR	Timestamp	0x60650320	Unsigned32	ro
4	VAR	Temperature	0x60651120	Signed32	ro
5	VAR	Intensity 1	0x60650420	Unsigned32	ro
6	VAR	Distance 1	0x60650520	Signed32	ro
7	VAR	Intensity 2	0x60650620	Unsigned32	ro
8	VAR	Distance 2	0x60650720	Signed32	ro
9	VAR	Sensor state	0x60650C20	Unsigned32	ro
10	VAR	Difference 1-2	0x60650D20	Signed32	ro

11	VAR	Statistic minimum value	0x60650E20	Signed32	ro
12	VAR	Statistic maximum value	0x60650F20	Signed32	ro
13	VAR	Statistic peak-peak value	0x60651020	Signed32	ro

A 7.3.2.9 Object 1A01 up to 1A63: TxPDO mapping

Contents are identical to object 1A00. The objects 1A01 - 1A63 are used for oversampling, see Chap. A 7.6.

A 7.3.2.10 Object 1C00h: Synchronous manager type

1C00	RECORD	Sync manager type			
------	--------	-------------------	--	--	--

Subindices

0	VAR	Number of entries	4	Unsigned8	ro
1	VAR	Subindex 001	0x01	Unsigned8	ro
2	VAR	Subindex 001	0x02	Unsigned8	ro
3	VAR	Subindex 001	0x03	Unsigned8	ro
4	VAR	Subindex 001	0x04	Unsigned8	ro

A 7.3.2.11 Object 1C13h: TxPDO assign

1C13	RECORD	TxPDO assign			
------	--------	--------------	--	--	--

Subindices

0	VAR	Number of entries	1	Unsigned8	ro
1	VAR	Subindex 001	0x1A00	Unsigned16	ro

A 7.3.2.12 Object 1C33h: Synchronous parameter

1C33	RECORD	SM input parameter
------	--------	--------------------

Subindices

0	VAR	Anzahl Einträge	9	Unsigned8	ro
1	VAR	Sync mode	0	Unsigned16	ro
2	VAR	Cycle time	200000	Unsigned32	ro
4	VAR	Sync modes supported	0x4005	Unsigned16	ro
5	VAR	Minimum cycle time	200000	Unsigned32	ro
6	VAR	Calc and copy time	0	Unsigned32	ro
8	VAR	Get Cycle time	0	Unsigned16	rw
11	VAR	SM event missed counter	0	Unsigned32	ro
12	VAR	Cycle exceeded counter	0	Unsigned32	ro
32	VAR	Sync error	false	BOOL	ro

A 7.3.3 Manufacturer Specific Objects

Overview

Index (h)	Name	Description
2001	User level	Login, logout, change password
2005	Sensor info	Sensor informations
2010	Setup	Load/save settings
2050	Advanced settings	Units sensor parameter
2131	Light source info	Laser power
2154	Measuring programs	Measuring programs
2161	Peak distance measurement selection	Selection of the peak at distance measurement
2181	Averaging/error handling / statistics	Averaging, error processing, statistics and spike correction
21B0	Digital interfaces	Digital interfaces, data selection
21C0	Ethernet	Ethernet
21E0	Zeroing/mastering	Zeroing/mastering
2250	Shutter mode/measuring rate	Measuring rate
2410	Trigger mode	Trigger modes
2711	ROI	Reduction of Region of Interest
2800	Material info	Actual material, description, refractive index
2801	Material select	Selection of used material
2802	Material table edit	Deleting, changing, adding, of materials
603F	Sensor - error	Sensor error (communication)
6065	Measvalues	Measurement values

The following describes the individual objects with their subindices. For a description of the functionality of the sensor parameters reference is made to the relevant chapters of the operating manual of the sensor.

A 7.3.3.1 Object 2001h: User level

2001	RECORD	User level			
Subindices					
0	VAR	Number of entries	7	Unsigned8	ro
1	VAR	Actual user	x	Unsigned8	ro
2	VAR	Login	*****	Visible string	wo
3	VAR	Logout	FALSE	BOOL	rw
4	VAR	Default user	x	Unsigned8	rw
5	VAR	Password old	*****	Visible string	wo
6	VAR	Password new	*****	Visible string	wo
7	VAR	Password repeat	*****	Visible string	wo

Further details can be found in the section Login, Change User Level, see Chap. 7.3.

Actual user, Default user

0 – User

1 – Expert

A 7.3.3.2 Object 2005h: Sensor informations (further)

2005	RECORD	Sensor info			
Subindices					
0	VAR	Number of entries	9	Unsigned8	ro
2	VAR	Sensor range	xx.xxxx	FLOAT32	ro
6	VAR	Sensor option no.	xxx	Visible String	ro
7	VAR	Date of correction table	xxxx/xx/xx	Visible String	ro
9	VAR	Name of correction table	DIFFUSE	Visible String	ro

Further details can be found in the section Sensor Information, see Chap. A 6.3.1.2 and object 1018h: Device identification.

A 7.3.3.3 Object 2010h: Loading/saving settings

2010	RECORD	Setup			
------	--------	-------	--	--	--

Subindices

0	VAR	Number of entries	4	Unsigned8	ro
1	VAR	Setup number	x	Unsigned8	rw
2	VAR	Setup save	FALSE	BOOL	rw
3	VAR	Setup load	FALSE	BOOL	rw
4	VAR	Keep device settings	FALSE	BOOL	rw

Further details can be found in the section Loading/saving settings, see Chap. [7.7.1](#).

A 7.3.3.4 Object 2050h: Advanced settings

2050	VAR	Advanced settings			
------	-----	-------------------	--	--	--

Subindices

0	VAR	Number of entries	1	Unsigned8	ro
1	VAR	Measuring unit	FALSE	BOOL	rw

Selects the unit for the sensor parameterization: 0 - Millimeter, 1 - Inch

A 7.3.3.5 Object 2101h: Reset

2101	VAR	Reset	FALSE	BOOL	rw
------	-----	-------	-------	------	----

Further details can be found in the section Booting the sensor, see Chap. [A 6.3.1.4](#).

A 7.3.3.6 Object 2105h: Factory settings

2105	RECORD	Factory settings			
Subindices					
0	VAR	Number of entries	3	Unsigned8	ro
1	VAR	Factory settings	FALSE	BOOL	rw
2	VAR	Keep device settings	FALSE	BOOL	rw
3	VAR	Reset material only	FALSE	BOOL	rw

Further details can be found in the section Extras, see Chap. 7.7.2, and Factory settings, see Chap. A 6.3.5.3.

A 7.3.3.7 Object 2131h: Light source

2131	RECORD	Light source info			
Subindices					
0	VAR	Number of entries	1	Unsigned8	ro
1	VAR	Laser power	2	Unsigned8	rw

Laser power, see Chap. 3.3 Exposure control)

0 - off, 1 - reduced, 2 - 100 % Laser power (1 mW)

A 7.3.3.8 Object 2154h: Measuring program

2154	VAR	Measuring program	0	Unsigned8	rw
------	-----	-------------------	---	-----------	----

Further details can be found in the section Measuring program, see Chap. 7.4.1.

0 - Displacement measurement diffuse, 1 - Displacement measurement direct, 2 - Thickness measurement

A 7.3.3.9 Object 2161h: Peak selection at distance measuring

2161	VAR	Peak distance measuring selection	0	Unsigned8	rw
------	-----	-----------------------------------	---	-----------	----

Further details can be found in the section Peak Selection displacement Measurement, see Chap. A 6.4.1.2.

0 – Output of peak with highest amplitude (standard for diffuse reflection)

1 – Output of peak with largest area

2 – Output of displacement 1 (complies with backside fading out of diffuse reflection)

A 7.3.3.10 Object 2181h: Averaging, error processing, statistics and spike correction

2181	RECORD	Averaging/error handling/statistics			
------	--------	-------------------------------------	--	--	--

Subindices

0	VAR	Number of entries	16	Unsigned8	ro
1	VAR	Measured value averaging type	x	Unsigned8	rw
2	VAR	Number of values for moving average	x	Unsigned32	rw
3	VAR	Number of values for median	x	Unsigned32	rw
4	VAR	Number of values for recursive average	x	Unsigned32	rw
5	VAR	Statistic depth	x	Unsigned16	rw
6	VAR	Reset statistic	x	BOOL	rw
7	VAR	Error handling	x	Unsigned8	rw
8	VAR	Number of held values	x	Unsigned16	rw
9	VAR	Video Averaging	x	Unsigned8	rw
12	VAR	Use spike correction	FALSE	BOOL	rw
13	VAR	Spike correction evaluation length	x	Unsigned8	rw
14	VAR	Spike correction range	xx	FLOAT32	rw
15	VAR	Spike correction count	x	Unsigned8	rw
16	VAR	Reset counter	x	Unsigned8	rw

Further details can be found in the section Averaging and error processing, see Chap. 7.4.4.

Measured value averaging type:

0 – No averaging

1 – Moving averaging (Number of values for moving average: 2, 4, 8, 16, 32, 64 and 128)

2 – Recursive averaging (Number of values for recursive average: 2...32768)

3 – Median (Number of values for median: 3, 5, 7 and 9)

Statistic depth: 0, 2, 4, 8, 16...16384; 0 = infinite

Error handling:

- 0 – Output of error value
- 1 – Hold last valid value for a number of measurement values (Number of held values: 0....1024, 0 = infinite)

Use spike correction

- 0 - without spike correction
- 1 - with spike correction

Spike correction evaluation length: Number of evaluated values (1 ... 10)

Spike correction range: Max. tolerance range in mm (0.0000000 ... 100.0000000)

Spike correction count: Number of corrected values (1 ... 100)

Reset counter:

- Bit 0: Reset time stamp counter
- Bit 1: Reset measured value counter
- Bit 2: Reset trigger counter

Resetting the individual counter is done by setting the corresponding bit to 1.

A 7.3.3.11 Object 21B0h: Digital interfaces, selection of transmitted data (measurements)

21B0	RECORD	Digital interfaces			
Subindices					
0	VAR	Number of entries	18	Unsigned8	ro
1	VAR	Output device	5	Unsigned8	rw
2	VAR	RS422 baud rate	x	Integer32	rw
3	VAR	Ethernet/EtherCAT	1	Integer8	rw
4	VAR	Distance 1	TRUE	BOOL	ro
5	VAR	Distance 2	FALSE	BOOL	ro
6	VAR	Intensity	FALSE	BOOL	rw
7	VAR	Sensor status	FALSE	BOOL	rw
8	VAR	Difference 1-2	FALSE	BOOL	ro
9	VAR	Statistic minimum value	FALSE	BOOL	rw
10	VAR	Statistic maximum value	FALSE	BOOL	rw
11	VAR	Statistic peak-peak value	FALSE	BOOL	rw
15	VAR	Shutter time	FALSE	BOOL	rw
16	VAR	Value counter	FALSE	BOOL	rw
17	VAR	Timestamp	FALSE	BOOL	rw
18	VAR	Temperature	FALSE	BOOL	rw

Further details can be found in the section Digital outputs, see Chap. 7.5.1.

21B0:01, Output device:

- 0 – No output channel
- 1 – RS422
- 5 – EtherCAT

21B0:02, RS422 baud rate: 9600, 115200, 230400, 460800, 691200, 921600, 1500000, 2000000, 3500000

21B0:03, EtherCAT-Ethernet: (Change of interface)

0 – Ethernet (works only from restarting, previously setup store)

1 – EtherCAT

➡ Save the settings with the object 2010:02 (setup store). Restart the sensor for activating the Ethernet interface subsequently.

Subindices 5...18: Data selection for the PDO mapping

Distance 1, Distance 2 and Difference 1-2 are not selectable, these values are selected automatically according to the selected measurement program.

A 7.3.3.12 Object 21C0h: Ethernet

21C0	RECORD	Ethernet			
------	--------	----------	--	--	--

Subindices

0	VAR	Number of entries	8	Unsigned8	ro
1	VAR	IP address	xxx.xxx.xxx.xxx	Visible String	rw
2	VAR	Subnet mask	xxx.xxx.xxx.xxx	Visible String	rw
3	VAR	Gateway	xxx.xxx.xxx.xxx	Visible String	rw
4	VAR	DHCP	FALSE	BOOL	rw
5	VAR	Measured value server protocol	0x00 (0)	Unsigned8	rw
6	VAR	Measured value server IP address	xxx.xxx.xxx.xxx	Visible String	rw
7	VAR	Measured value server port	x	Unsigned16	rw
8	VAR	MAC address	xxx.xxx.xxx.xxx	Visible String	ro

Further details can be found in the section Ethernet and Setting Measurement Server, see Chap. A 6.3.4.1, see Chap. A 6.3.4.2.

A 7.3.3.13 Object 21E0h: Zeroing/Mastering

21E0	RECORD	Zeroing/Mastering			
------	--------	-------------------	--	--	--

Subindices

0	VAR	Number of entries	5	Unsigned8	ro
2	VAR	Master value	x.xx	FLOAT32	rw
3	VAR	Zeroing/Mastering active	FALSE	BOOL	ro
4	VAR	Mastering	FALSE	BOOL	rw
5	VAR	Reset master value	FALSE	BOOL	rw

Further details can be found in the section Setting zero and masters, see Chap. [7.4.5](#).

A 7.3.3.14 Object 2250h: Measuring rate

2250	RECORD	Shutter mode/measuring rate			
------	--------	-----------------------------	--	--	--

Subindices

0	VAR	Number of entries	4	Unsigned8	ro
2	VAR	Measuring rate	x	Integer8	rw

Further details can be found in the section Measuring rate, see Chap. [7.4.2](#)

Measuring rate:

- 0 – 49.140 kHz
- 1 – 30 kHz
- 2 – 20 kHz
- 3 – 10 kHz
- 4 – 5 kHz
- 5 – 2.5 kHz
- 6 – 1.5 kHz

A 7.3.3.15 Object 2410h: Triggermodi

2410	RECORD	Trigger mode			
Subindices					
0	VAR	Number of entries	10	Unsigned8	ro
1	VAR	Trigger mode	0	Unsigned8	rw
2	VAR	Trigger edge/level	0	Unsigned8	rw
3	VAR	Number of values per trigger	1	Unsigned16	rw
8	VAR	Software triggering pulse	FALSE	BOOL	rw
9	VAR	Triggering measurement input / output	FALSE	BOOL	rw
10	VAR	Termination synchronous/trigger input	1	BOOL	rw

Further details can be found in the section Triggering, see Chap. 7.6.1.

Trigger mode:

- 0 – No triggering
- 1 – Level triggering
- 2 – Edge triggering
- 3 – Software triggering

Trigger edge/level:

- 0 – At edge triggering: Falling edge; at level triggering: Low
- 1 – At edge triggering: Rising edge; at level triggering: High

Number of values per trigger pulse: Number of output data after a trigger pulse for edge or software triggering, 0...16382, 16383 = infinite, 0 = Stop

Triggering measurement input or output:

- 0 – Triggering of measurement input
- 1 – Triggering of measurement output

A 7.3.3.16 Object 2711h: Reduction of region of interest

2711	RECORD	Range of interest			
------	--------	-------------------	--	--	--

Subindices

0	VAR	Number of entries	2	Unsigned8	ro
1	VAR	Range of interest start	x	Unsigned16	rw
2	VAR	Range of interest end	x	Unsigned16	rw

Further details can be found in the section Reduction of region of interest, see Chap. [A 6.4.2.1](#).

A 7.3.3.17 Object 2800h: Material info

2800	RECORD	Material info			
------	--------	---------------	--	--	--

Subindices

0	VAR	Number of entries	3	Unsigned8	ro
1	VAR	Material name	xxxxx	Visible String	rw
2	VAR	Material description	xxxxxx	Visible String	rw
3	VAR	n (refractive index)	x.xxxx	FLOAT32	rw

Further details can be found in the section Material data base, see Chap. [7.4.6](#).

Material name: actual selected material for a thickness measurement

Material description: Description of actual selected material

n: Refractive index of actual selected material

Here the current material can also be edited in expert mode. Any custom settings will be saved immediately.

A 7.3.3.18 Object 2801h: Material select

2801	RECORD	Material selection			
------	--------	--------------------	--	--	--

Subindices

0	VAR	Number of entries	2	Unsigned8	ro
1	VAR	Material names	„xx“ „xx“ ...	Visible String	ro
2	VAR	Selected material	xx	Visible String	rw

Material names: Output of all names of materials contained in the material table

Select material: Output of the actual selected material or input of a desired material from the material table

A 7.3.3.19 Object 2802h: Material table edit

2802	RECORD	Material table edit			
------	--------	---------------------	--	--	--

Subindices

0	VAR	Number of entries	3	Unsigned8	ro
1	VAR	Material delete	x	Visible String	rw
2	VAR	Reset materials	x	BOOL	rw
3	VAR	New material	x	BOOL	rw

Material delete: Specification of name to be deleted from the material table

Reset Materials: Resetting the material table to factory settings

New material: Creating a new material in the material table. Then the newly created material („NewMaterial“) is to be edit in object 2800h „Material info“.

A 7.3.3.20 Object 603Fh: Sensor - error

603F	RECORD	Sensor error			
------	--------	--------------	--	--	--

Subindices

0	VAR	Number of entries	2	Unsigned8	ro
1	VAR	Sensor error number	x	Unsigned16	ro
2	VAR	Sensor error description	x	Visible String	ro

Error messages, see Chap. [A 6.7](#).

Sensor error number: Output of sensor error in communication

Sensor error description: Sensor error as plain text

A 7.3.3.21 Object 6065h: Measurement values

6065	RECORD	Measuring values			
------	--------	------------------	--	--	--

Subindices

0	VAR	Number of entries	16	Unsigned8	ro
1	VAR	Distance 1	x	Unsigned32	ro
...		...			

All in the object 21B0h Digital interfaces selected measurement values.

A 7.4 Error Codes for SDO Services

In case of a negative evaluation of a SDO requirement, a corresponding error code is output in „Abort SDO Transfer Protocol“.

Error code hexadecimal	Meaning
0503 0000	Toggle-Bit has not changed.
0504 0000	SDO protocol timeout expired
0504 0001	Invalid command registered
0504 0005	Not enough memory

0601 0000	Access to object (parameter) not supported
0601 0001	Attempt to write to a “read-only parameter“
0601 0002	Attempt to write to a “read-only parameter“
0602 0000	Object (parameter) is not listed in the object directory
0604 0041	Object (parameter) is not mapped on PDO
0604 0042	Number or length of objects to be transmitted exceeds PDO length
0604 0047	General internal device incompatibility
0606 0000	Excess denied because of a hardware error
0607 0010	False data type or length of service parameter is incorrect
0607 0012	False data type or length of service parameter is too large
0607 0013	False data type or length of service parameter is too small
0609 0011	Subindex does not exist
0609 0030	Invalid value of parameter (only for write access)
0609 0031	Value of the parameter too large
0609 0032	Value of the parameter too small
0609 0036	Maximum value deceeds minimum value
0800 0000	General error
0800 0020	Data can not be transmitted or saved in application
0800 0021	Data can not be transmitted or saved in application, because of local control
0800 0022	Data can not be transmitted or saved in application, because device state
0800 0023	Dynamic generation of object directory failed or no object directory is available

A 7.5 Measurement Data Formats

Measurement values

- Exposure time (1 x 32 bit)
- Measurement value counter (1 x 32 bit)
- Time stamp (1 x 32 bit)
- Displacement values / Intensities ($n * ((i+1) * 2) * 32$ bit)
- Status (1 x 32 bit)
- Differences $((n-1) * 32$ bit)
- Statistic values (Min/Max/Peak2Peak) (per 32 bit)

$n = 1 \dots 2$

For $n = 1$: Displacement measurement (diffuse / direct reflection)

For $n = 2$: Difference = Thickness (direct reflection)

$i = 0 / 1$

für $i = 0$: Intensity output is off

für $i = 1$: Intensity output is on

The distance values are output in nanometers. You will find further details on the structure of the measuring values in data format, see Chap. 8.2.2.

A 7.6 ILD2300 with Oversampling in EtherCAT

Objects 1A00h...1A63: TxPDO Mapping

Object 1C13: TxPDO assign

The last arised measurement value data record is transmitted to EtherCAT Master with each fieldbus cycle during operation without oversampling. Many measurement value data records are not available therefore for large fieldbus cycle times. All (or selectable) measurement value data records are collected with the configurable oversampling and are transmitted together to the master with the next fieldbus cycle.

Example:

The fieldbus/EtherCAT is operated with a cycle time of 1 ms, because, for example the PLC is operated with 1 ms cycle time. For this reason an EtherCAT frame is sent to the ILD2300 for collection of process data every 1 ms. If the measuring rate in ILD2300 is set to 10 kHz, an oversampling of 10 should be set.

Procedure:

- ➔ Choose the measuring data to be set in the object 0x21B0 (Digital interfaces) in preoperational state, for example
- „Distance 1 Ethernet/EtherCAT“ (is always selected and not deselected)
 - „Value counter Ethernet/EtherCAT“

The screenshot displays the 'Unknown - TwinCAT System Manager' application. The left-hand tree view shows the configuration hierarchy: SYSTEM - Configuration > I/O - Configuration > I/O Devices > Device 3 (EtherCAT) > Digital interface (21B0:0). The right-hand pane shows the configuration table for the selected object. The 'Set Value Dialog' is open, showing the 'Value counter Ethernet/EtherCAT' parameter set to '1' in the 'Bool' field. The 'OK' button in the dialog is circled in red.

Index	Name	Flags	Value
2154	Measuring program	RW	0
2161	Peak distance measurement selection	RW	0
2181:0	Averaging/error handling/statistics	RO	> 11 <
21B0:0	Digital interface	RO	> 17 <
21B0:01	Output device	RW	5
21B0:02	RS422 baud rate	RW	2000000
21B0:03	Ethernet/EtherCAT	RW	1
	Distance 1 Ethernet/EtherCAT	RW	TRUE
	Distance 2 Ethernet/EtherCAT	RW	FALSE
	Intensity Ethernet/EtherCAT	RW	FALSE
	Error state Ethernet/EtherCAT	RW	FALSE
	Difference 1-2 Ethernet/EtherCAT	RW	FALSE
	Statistic minimum value Ethernet/Ethe...	RW	FALSE
	Statistic maximum value Ethernet/Eth...	RW	FALSE
	Statistic peak-peak value Ethernet/Et...	RW	FALSE
	Shutter time Ethernet/EtherCAT	RW	FALSE
	Value counter Ethernet/EtherCAT	RW	TRUE
	Timestamp Ethernet/EtherCAT	RW	FALSE
	Ethernet	RO	> 8 <
	Zeriong/Mastering	RO	> 5 <
	Measuring rate	RO	> 4 <

➔ Then read the object directory from the ILD2300.

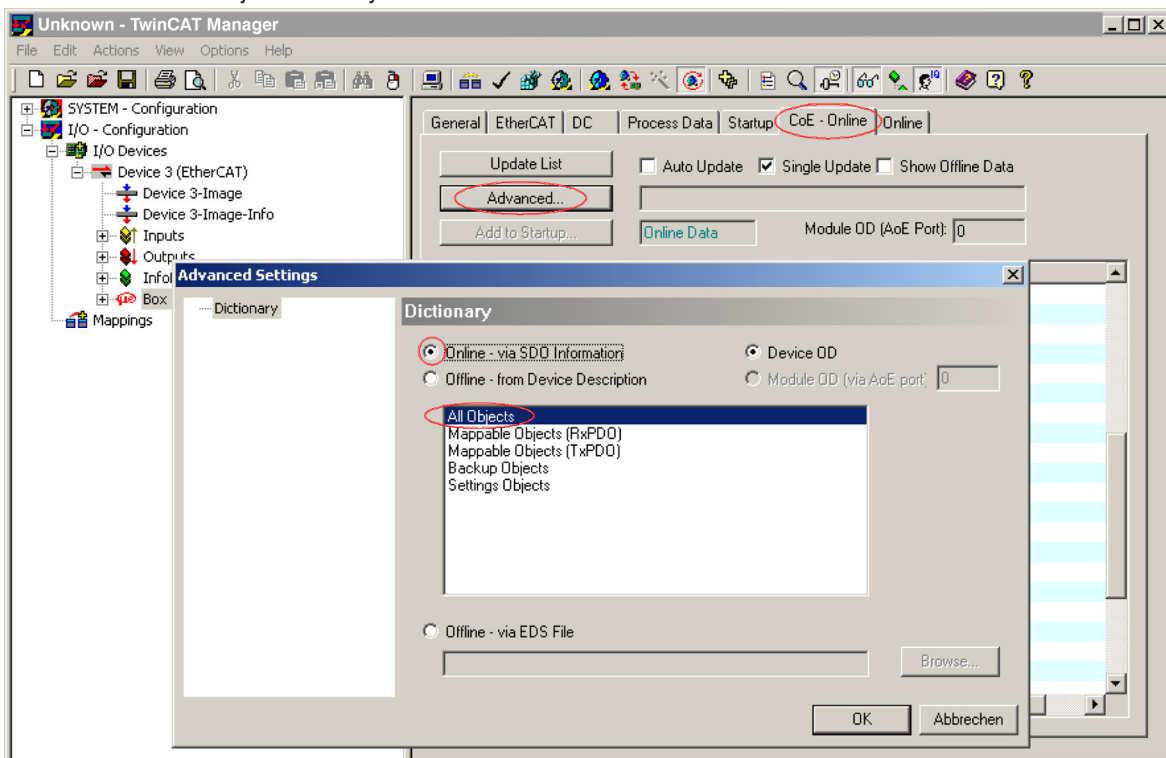

➔ Read the PDO info in the process data tab Load PDO info from device from the ILD2300.

The screenshot shows the TwinCAT Manager interface with the following components:

- Tree View (Left):**
 - SYSTEM - Configuration
 - I/O - Configuration
 - I/O Devices
 - Device 3 (EtherCAT)
 - Device 3-Image
 - Device 3-Image-Info
 - Inputs
 - Outputs
 - InfoData
 - Box 1 (ILD 2300)
 - Mappings

- Process Data Tab (Top):**
- General | EtherCAT | DC | **Process Data** | Startup | CoE - Online | Online
- Sync Manager Table:**

SM	Size	Type	Flags
0	256	MbxOut	
1	256	MbxIn	
2	0	Outputs	
3	4	Inputs	
- PDO List Table:**

Index	Size	Name	Flags
0x1A00	4.0	Measvalues	
- PDO Assignment (0x1C13):**
- 0x1A00
- PDO Content (0x1A00):**

Index	Size	Offs	Name
0x6065:05	4.0	0.0	Distance 1 ethernet/ECAT
		4.0	
- Download Section:**
- Download
 - PDO Assignment
 - PDO Configuration
- Predefined PDO Assignment:**
- Predefined PDO Assignment: (none)
- Load PDO info from device**
- Sync Unit Assignment...

The amount of process data and the assignment of SyncManager can now be seen as delivered:

The screenshot shows the TwinCAT Manager interface with the following components:

- Left Panel (Tree View):**
 - SYSTEM - Configuration
 - I/O - Configuration
 - I/O Devices
 - Device 3 (EtherCAT)
 - Device 3-Image
 - Device 3-Image-Info
 - Inputs
 - Outputs
 - InfoData
 - Box 1 (ILD 2300)
 - Mappings

- Right Panel (Configuration):**
- Tabs: General, EtherCAT, DC, Process Data, Startup, CoE - Online, Online
- Sync Manager:**

SM	Size	Type	Flags
0	256	MbxOut	
1	256	MbxIn	
2	0	Outputs	F
3	8	Inputs	
- PDD List:**

Index	Size	Name	Flg
0x1A00	8.0	Sample 0	F
0x1A01	8.0	Sample 1	F
0x1A02	8.0	Sample 2	F
0x1A03	8.0	Sample 3	F
0x1A04	8.0	Sample 4	F
0x1A05	8.0	Sample 5	F
0x1A06	8.0	Sample 6	F
0x1A07	8.0	Sample 7	F
0x1A08	8.0	Sample 8	F
0x1A09	8.0	Sample 9	F
- PDD Assignment (0x1C13):**
 - 0x1A00
 - 0x1A01
 - 0x1A02
 - 0x1A03
 - 0x1A04
 - 0x1A05
 - 0x1A06
 - 0x1A07
- PDD Content (0x1A00):**

Index	Size	Ofs	Name
0x6065:02	4.0	0.0	Value counter Ethernet/EtherCAT
0x6065:05	4.0	4.0	Distance 1 Ethernet/EtherCAT
		8.0	
- Buttons:**
 - Download
 - PDD Assignment
 - PDD Configuration
 - Predefined PDD Assignment: (none)
 - Load PDD info from device
 - Sync Unit Assignment...

10 measuring data records are selected in the PDD assignment (0x1C13) for setting the oversampling (in example 10).

The screenshot displays the TwinCAT Manager interface for configuring EtherCAT. The left sidebar shows the project tree with 'Device 3 (EtherCAT)' selected. The main window is divided into several panels:

- Sync Manager:** A table listing synchronization managers (SM) with columns for SM, Size, Type, and Flags. SM 3 is selected and circled in red.

SM	Size	Type	Flags
0	256	MbxOut	
1	256	MbxIn	
2	0	Outputs	F
3	80	Inputs	
- PDD List:** A table listing Process Data Objects (PDD) with columns for Index, Size, Name, Flags, and SM. SM 3 is assigned to Sample 0.

Index	Size	Name	Flags	SM
0x1A00	8.0	Sample 0	F	3
0x1A01	8.0	Sample 1	F	3
0x1A02	8.0	Sample 2	F	3
0x1A03	8.0	Sample 3	F	3
0x1A04	8.0	Sample 4	F	3
0x1A05	8.0	Sample 5	F	3
0x1A06	8.0	Sample 6	F	3
0x1A07	8.0	Sample 7	F	3
0x1A08	8.0	Sample 8	F	3
0x1A09	8.0	Sample 9	F	3
0x1A0A	8.0	Sample 10	F	
0x1A0B	8.0	Sample 11	F	
0x1A0C	8.0	Sample 12	F	
0x1A0D	8.0	Sample 13	F	
0x1A0E	8.0	Sample 14	F	
0x1A0F	8.0	Sample 15	F	
0x1A10	8.0	Sample 16	F	
0x1A11	8.0	Sample 17	F	
0x1A12	8.0	Sample 18	F	
0x1A13	8.0	Sample 19	F	
0x1A14	8.0	Sample 20	F	
0x1A15	8.0	Sample 21	F	
0x1A16	8.0	Sample 22	F	
0x1A17	8.0	Sample 23	F	
- PDD Assignment (0x1C13):** A list of PDDs assigned to SM 3, with checkboxes. SM 3 is assigned to PDDs 0x1A00 through 0x1A09.

PDD Index	Assignment
0x1A00	<input checked="" type="checkbox"/>
0x1A01	<input checked="" type="checkbox"/>
0x1A02	<input checked="" type="checkbox"/>
0x1A03	<input checked="" type="checkbox"/>
0x1A04	<input checked="" type="checkbox"/>
0x1A05	<input checked="" type="checkbox"/>
0x1A06	<input checked="" type="checkbox"/>
0x1A07	<input checked="" type="checkbox"/>
0x1A08	<input checked="" type="checkbox"/>
0x1A09	<input checked="" type="checkbox"/>
0x1A0A	<input type="checkbox"/>
0x1A0B	<input type="checkbox"/>
- PDD Content (0x1A00):** A table showing the content of PDDs.

Index	Size	Offs	Name
0x6065:02	4.0	0.0	Value counter Ethernet/EtherCAT
0x6065:05	4.0	4.0	Distance 1 Ethernet/EtherCAT
		8.0	

➡ Now select the input `Reload Devices (F4)` in the `Actions` menu. These settings are loaded in the `ILD2300`.

Sync Manager:

SM	Size	Type	Flags
0	256	MbxOut	
1	256	MbxIn	
2	0	Outputs	F
3	80	Inputs	

PDO List:

Index	Size	Name	Flags
0x1A00	8.0	Sample 0	F
0x1A01	8.0	Sample 1	F
0x1A02	8.0	Sample 2	F
0x1A03	8.0	Sample 3	F
0x1A04	8.0	Sample 4	F
0x1A05	8.0	Sample 5	F
0x1A06	8.0	Sample 6	F
0x1A07	8.0	Sample 7	F
0x1A08	8.0	Sample 8	F
0x1A09	8.0	Sample 9	F
0x1A0A	8.0	Sample 10	F

PDO Assignment (0x1C13):

<input checked="" type="checkbox"/>	0x1A00
<input checked="" type="checkbox"/>	0x1A01
<input checked="" type="checkbox"/>	0x1A02
<input checked="" type="checkbox"/>	0x1A03
<input checked="" type="checkbox"/>	0x1A04
<input checked="" type="checkbox"/>	0x1A05
<input checked="" type="checkbox"/>	0x1A06
<input checked="" type="checkbox"/>	0x1A07

PDO Content (0x1A00):

Index	Size	Offs	Name
0x6065:02	4.0	0.0	Value counter Ethernet/EtherCAT
0x6065:05	4.0	4.0	Distance 1 Ethernet/EtherCAT
	8.0		

Device Tree (Left):

- SYSTEM - Configuration
 - I/O - Configuration
 - I/O Devices
 - Device 3 (EtherCAT)
 - Device 3-Image
 - Device 3-Image-Info
 - Outputs
 - InfoData
 - optoNCDT 2300 (1)
 - Sample 0
 - Value counter Ethernet/EtherCAT
 - Distance 1 Ethernet/EtherCAT
 - Sample 1
 - Value counter Ethernet/EtherCAT
 - Distance 1 Ethernet/EtherCAT
 - Sample 2
 - Value counter Ethernet/EtherCAT
 - Distance 1 Ethernet/EtherCAT
 - Sample 3
 - Value counter Ethernet/EtherCAT
 - Distance 1 Ethernet/EtherCAT
 - Sample 4
 - Value counter Ethernet/EtherCAT
 - Distance 1 Ethernet/EtherCAT
 - Sample 5
 - Value counter Ethernet/EtherCAT
 - Distance 1 Ethernet/EtherCAT
 - Sample 6
 - Value counter Ethernet/EtherCAT
 - Distance 1 Ethernet/EtherCAT
 - Sample 7
 - Value counter Ethernet/EtherCAT
 - Distance 1 Ethernet/EtherCAT
 - Sample 8
 - Value counter Ethernet/EtherCAT
 - Distance 1 Ethernet/EtherCAT
 - Sample 9
 - Value counter Ethernet/EtherCAT
 - Distance 1 Ethernet/EtherCAT
 - Sample 10
 - Value counter Ethernet/EtherCAT
 - Distance 1 Ethernet/EtherCAT
 - WcState
 - InfoData
 - Mappings

Device Properties Table (Bottom):

| Name | Online | Type | Size |
|---------------------------------|-----------------------|------------|------|
| Value counter Ethernet/EtherCAT | 0x0056351B (5649691) | UDINT | 4.0 |
| Distance 1 Ethernet/EtherCAT | 0x00CB30D2 (13316306) | UDINT | 4.0 |
| Value counter Ethernet/EtherCAT | 0x0056351C (5649692) | UDINT | 4.0 |
| Distance 1 Ethernet/EtherCAT | 0x00CB3080 (13316224) | UDINT | 4.0 |
| Value counter Ethernet/EtherCAT | 0x0056351D (5649693) | UDINT | 4.0 |
| Distance 1 Ethernet/EtherCAT | 0x00CB3175 (13316469) | UDINT | 4.0 |
| Value counter Ethernet/EtherCAT | 0x0056351E (5649694) | UDINT | 4.0 |
| Distance 1 Ethernet/EtherCAT | 0x00CB3080 (13316224) | UDINT | 4.0 |
| Value counter Ethernet/EtherCAT | 0x0056351F (5649695) | UDINT | 4.0 |
| Distance 1 Ethernet/EtherCAT | 0x00CB3080 (13316224) | UDINT | 4.0 |
| Value counter Ethernet/EtherCAT | 0x00563520 (5649696) | UDINT | 4.0 |
| Distance 1 Ethernet/EtherCAT | 0x00CB302E (13316142) | UDINT | 4.0 |
| Value counter Ethernet/EtherCAT | 0x00563521 (5649697) | UDINT | 4.0 |
| Distance 1 Ethernet/EtherCAT | 0x00CB31C6 (13316550) | UDINT | 4.0 |
| Value counter Ethernet/EtherCAT | 0x00563522 (5649698) | UDINT | 4.0 |
| Distance 1 Ethernet/EtherCAT | 0x00CB2FDD (13316061) | UDINT | 4.0 |
| Value counter Ethernet/EtherCAT | 0x00563523 (5649699) | UDINT | 4.0 |
| Distance 1 Ethernet/EtherCAT | 0x00CB3F8B (13315979) | UDINT | 4.0 |
| Value counter Ethernet/EtherCAT | 0x00563524 (5649700) | UDINT | 4.0 |
| Distance 1 Ethernet/EtherCAT | 0x00CB3175 (13316469) | UDINT | 4.0 |
| WcState | 0 | BOOL | 0.1 |
| State | 0x0008 (8) | UINT | 2.0 |
| AdsAddr | 00 00 00 00 00 E9 03 | AMSADDRESS | 8.0 |

Every process data frame now contains 80 bytes measuring data (2 measurement values per 4 bytes * 10 measuring data records).

- ① Process data frame
- ② Size measuring data in byte
- ③ Number of measurement values (in example 2)
- ④ Memory requirements in bytes per measurement value

In order to ensure that no samples will disappear, due to the high asymmetry between master cycle and slave cycle, the master cycle time is subject to be less than the time which is required for the generation of a block consisting of x samples.

A complete block is generated from the stated samples and first presented to the EtherCAT side after all stated samples have been written into the block. If the time for the writing into the block is shorter than the master cycle time, unfortunately single blocks cannot be transmitted. Reason: The next block has already been picked up by the master cycle.

Time for n samples < master cycle time

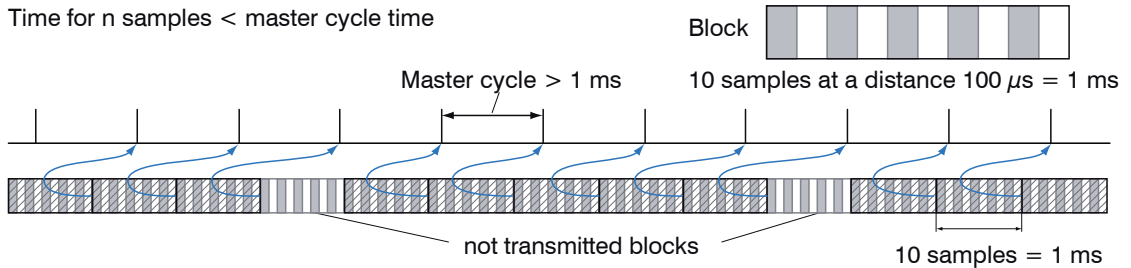

If the number of samples selected is too high, i.e. the time for the filling of a block is longer than the master cycle time, each block is picked up by a master cycle. However, single blocks and therefore samples are transmitted twice or even more often. This can be detected on the master side by the transmission of the Timestamp or Valuecounter, see object 0x21B0.

Time for n samples > master cycle time

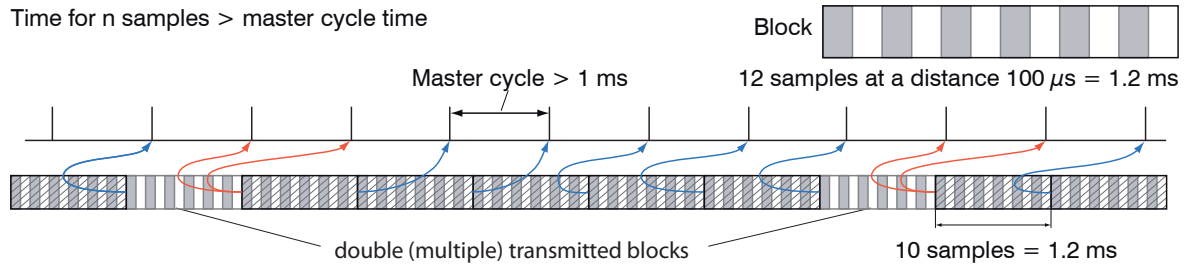

A 7.7 ILD2300 Distributed Clock

The synchronization of ILD2300 among each other in the EtherCAT is realized via the Distributed Clock. With it it is not necessary or possible to transmit the synchronous signals via the synchronous input or output of the sensor.

Unlike the Ethernet the synchronization does not occur via external signals but about the clocks in the sensors. This results in the synchronous modes *Synchronization from* (= Free Run), *Slave* and *Slave alternating*.

A 7.7.1 Synchronization

ILD2300, that support the synchronization in the EtherCAT, offer the additional tab **DC** in the TwinCat Manager. The different synchronous modes can be adjusted via this using the drop-down menu. Besides the mode *FreeRun* there are three possible settings for each measuring rate.

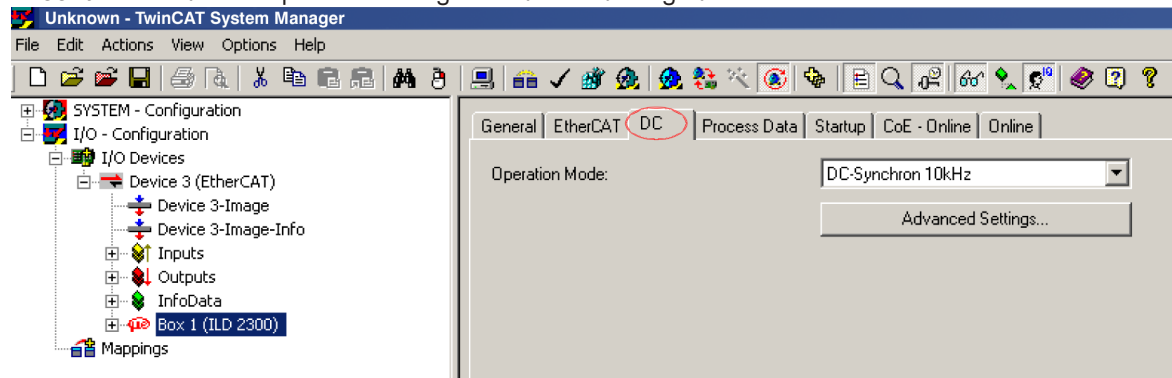

A 7.7.1.1 Synchronization off

In the mode `FreeRun` no synchronization of sensors occurs.

A 7.7.1.2 Slave

In the mode `DC_Synchron xxxkHz` the sensor is switched in the synchronization mode `Slave`.

Besides `xxx` means the measuring rate. The sensor measures with the rate selected by `xxx`.

A 7.7.1.3 Slave Alternating

The sensor is switched alternately in the synchronization mode `Slave` with the modes `DC_Synchronous xxxkHz alt. 1` and `DC_Synchronous xxxkHz alt. 2`. Besides `xxx` means the measuring rate, whereby it should be noted, that the laser is switched on in the alternating mode only in every second cycle and a measurement value is entered.

That means, the effective measurement rate corresponds to half the selected rate. It makes sense to use this mode, if two sensors “see” each other. For this case the first sensor is to be operated in the mode `DC_Synchron xxxkHz alt. 1` and the second sensor in the mode `DC_Synchron xxxkHz alt. 2` or vice versa.

A 7.7.1.4 Apply Selected Settings

Once the required synchronization mode is selected using the drop-down-menu, it is applied with F4.

A 7.7.1.5 Setting Regardless of TwinCat

The setting of the synchronisation mode in EtherCAT occurs via the setting of the registers for the Distributed Clocks. You will find details under www.beckhoff.de or www.ethercat.org. For reading the settings in the TwinCAT it is possible to display the requirements of the XML file using the button `Advanced Settings`.

A 7.7.1.6 Error Message

The error „Inconsistent Settings“ can occur in DC mode, if the `Sync0` frequency is not a valid sensor frequency.

A 7.8 Measuring Rates and Measurement Values with EtherCAT

The full data rate including all selectable additional data is to be reached with a measuring rate of 10 kHz maximum. If only one measurement value is selected all measurement values are transmitted to 20 kHz via EtherCAT. Only every second value is transmitted with 30 kHz and only every third measurement value is transmitted with 49.140 kHz via EtherCAT.

| | | Number of selected measurement values
(distance 1, intensity 1, measurement value counter, ..) | | | | |
|-----------------------|------------|---|---|------------|---|-----------|
| | | 1 | 2 | 3 | 4 | 5 |
| Measuring rate | 1.5 kHz | 1.5 kHz | | | | |
| | 2.5 kHz | 2.5 kHz | | | | |
| | 5 kHz | 5 kHz | | | | |
| | 10 kHz | 10 kHz | | | | |
| | 20 kHz | 20 kHz | | 10 kHz | | |
| | 30 kHz | 15 kHz | | | | 10 kHz |
| | 49.140 kHz | 16.34 kHz | | 12.225 kHz | | 9.804 kHz |
| | | Data rate | | | | |

A 7.9 Meaning of EtherCAT-STATUS-LED

| | |
|--|-----------------------------|
| green off | INIT status |
| green flashing 2.5 Hz | PRE-OP status |
| green Single Flash, 200 ms ON / 1000 ms OFF | SAFE-OP status |
| green on | OP status |
| red off | No error |
| red flashing 2.5 Hz | Invalid configuration |
| red Single Flash, 200 ms ON / 1000 ms OFF | Not requested status change |
| red Double Flash, 200 ms ON / 200 ms OFF
200 ms ON 400 ms OFF | Timeout of watchdog |
| red flashing 10 Hz | Error initializing |

A 7.10 EtherCAT Configuration with the Beckhoff TwinCAT®-Manager

EtherCAT®-Slave information files are XML files, which specify the characteristics of the Slave device for the EtherCAT® Master and contain informations to the supported communication objects. EtherCAT®-Slave information files for micro-epsilon sensors are available via www.micro-epsilon.com. For example the Beckhoff TwinCAT Manager can be used as EtherCAT Master on the PC.

- ➔ Copy the device description file (EtherCAT®-Slave-Information) optoNCDT2300.xml from the included CD in the directory \\TwinCAT\IO\EtherCAT.
- ➔ Restart the TwinCAT Manager.

Now, the sensor can be configured via EtherCAT®.

Searching for a device:

- ➔ Select the tab I/O Devices, then Scan Devices.
- ➔ Confirm with OK.

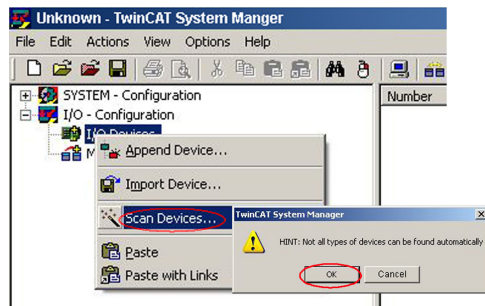

- ➔ Select a network card, where EtherCAT®-Slaves should be searching for.



- ➔ Confirm with OK.



It appears the window Search for new boxes (EtherCAT®-Slaves).

- ➔ Confirm with Yes.

The ILD 2300 is now shown in a list.

➡ Now confirm the window Activate Free Run with Yes.

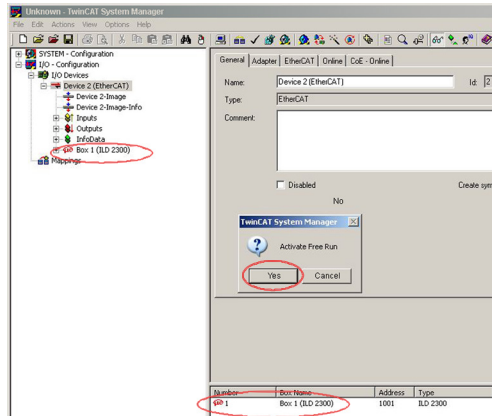

The current status should be at least PREOP, SAFEOP or OP on the Online side.

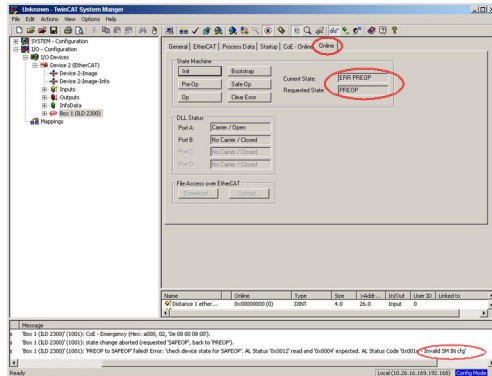

If ERP PREOP appears in the “current status”, the cause is reported in the message window. In the example here the incorrect initialization of the synchronization manager is the reason. This will be the case if the settings for the PDO mapping in the sensor are different from the settings in the ESI file (optoNCDT2300.xml). On delivery of the sensor only one measurement value (distance 1) is set as output size (in both the sensor and in the ESI file). To configure the synchronous manager correctly, it is first necessary to read the object directory of ILD2300:

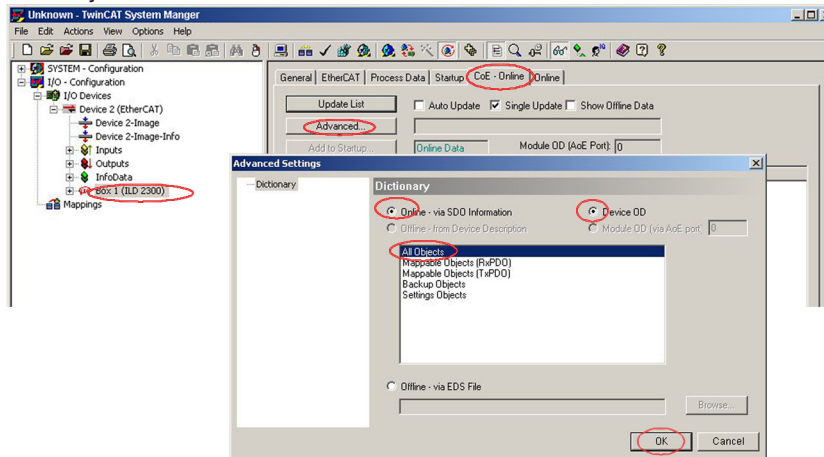

➡ Confirm with OK.

After reading the object directory:

The screenshot shows the TwinCAT System Manager interface. The left sidebar displays a tree view of the system configuration, including I/O Devices, Device 2 (EtherCAT), and its various components like Device 2-Image, Inputs, Outputs, InfoData, and Mappings. The main window is titled 'Unknown - TwinCAT System Manager' and shows the 'Process Data' tab selected. The 'Update List' section has 'Auto Update' and 'Single Update' checked. Below this is a table of objects with the following columns: Index, Name, Flags, and Value.

| Index | Name | Flags | Value |
|----------|-------------------------------------|-------|----------------------|
| 1000 | Device type | RO | 0x00020000 (1 31072) |
| 1001 | Error register | RO | 0x00 (0) |
| 1003.0 | Error history | RW | > 0 c |
| 1008 | Device name | RO | ILD2300 |
| 1009 | Hardware version | RO | V 4.076 |
| 100A | Software version | RO | V 4.104 |
| + 1018.0 | Identity | RO | > 4 c |
| + 1A00.0 | TxPDO | RO | > 1 c |
| + 1C00.0 | Sync manager type | RO | > 4 c |
| + 1C13.0 | TxPDO assign | RW | > 11 c |
| + 2001.0 | Use level | RO | > 7 c |
| + 2005.0 | Controller info | RO | > 9 c |
| + 2010.0 | Setup | RO | > 5 c |
| + 2131.0 | Light source info | RO | > 2 c |
| - 2154 | Measuring programme | RW | 0 |
| - 2161 | Peak distance measurement selection | RW | 0 |
| + 2181.0 | Averaging/error handling/statistics | RO | > 11 c |
| + 2180.0 | Digital interfaces | RO | > 17 c |
| + 21C0.0 | Ethernet | RO | > 8 c |
| + 21E0.0 | Zeroing/Mastering | RO | > 5 c |
| + 2250.0 | Measuring rate | RO | > 4 c |
| + 2410.0 | Trigger mode | RO | > 10 c |
| + 2711.0 | ROI | RO | > 2 c |
| + 2800.0 | Material info | RO | > 3 c |
| + 2801.0 | Material selection | RO | > 2 c |
| + 2802.0 | Material table edit | RO | > 2 c |
| + 603F.0 | Sensor error | RO | > 2 c |
| - 60E5.n | Measurement values | DN | > 16 c |

Below the object list is a table showing the online status and configuration of these objects:

| Name | Online | Type | Size | Addr... | In/Out | User ID | Linked to |
|---------------------|---------------------|-------------|------|---------|--------|---------|-----------|
| Distance 1 Ether... | 0x005997FB (S871... | UINT | 4.0 | 26.0 | Input | 0 | |
| WcState | 0 | BOOL | 0.1 | 1522.0 | Input | 0 | |
| State | 0x0008 (8) | UINT | 2.0 | 1548.0 | Input | 0 | |
| AddrAddr | 00 00 00 00 00 E... | AMSDADDRESS | 8.0 | 1550.0 | Input | 0 | |
| ... | ... | ... | ... | ... | ... | ... | ... |

On the Process Data side the PDO assignments can be read from the device.

The screenshot shows the TwinCAT System Manager interface with the following components:

- Tree View:** SYSTEM - Configuration > I/O - Configuration > Device 2 (EtherCAT) > InfoData > Box 1 (ILD 2300)
- Process Data Tab:**
 - Sync Manager:**

| SM | Size | Type | Flags |
|----|------|---------|-------|
| 0 | 256 | MbxOut | |
| 1 | 256 | MbxIn | |
| 2 | 0 | Outputs | |
| 3 | 8 | Inputs | |
 - PDO List:**

| Index | Size | Name | Flags |
|--------|------|-------|-------|
| 0x1A00 | 8.0 | TxPDO | F |
 - PDO Assignment (0x1C13):**

| Index | Size | Offs | Name |
|-----------|------|------|------------------------------|
| 0x0065:04 | 4.0 | 0.0 | Intensity 1 |
| 0x0065:05 | 4.0 | 4.0 | Distance 1 Ethernet/EtherCAT |
 - Buttons:** Download (PDD Assignment, PDD Configuration), Load PDO info from device
- Message Log:**

| Server (Port) | Timestamp | Message |
|---------------|----------------------------|---|
| (65535) | 07.10.2011 09:33:20 372 ms | 'Box 1 (ILD 2300)' (1001): CoE - Emergency (Hex: a000_02, '0e 08 00 08 00'). |
| (65535) | 07.10.2011 09:33:20 325 ms | 'Box 1 (ILD 2300)' (1001): state change aborted (requested 'SAFEOP', back to 'PREOP'). |
| (65535) | 07.10.2011 09:33:20 325 ms | 'Box 1 (ILD 2300)' (1001): 'PREOP to SAFEOP' failed! Error: 'check device state for 'SAFEOP'. AL Status '0x0012' read and '0x00 |

➡ Now select the tab `Reload Devices` under the menu item `Actions`.
The configuration is now complete.

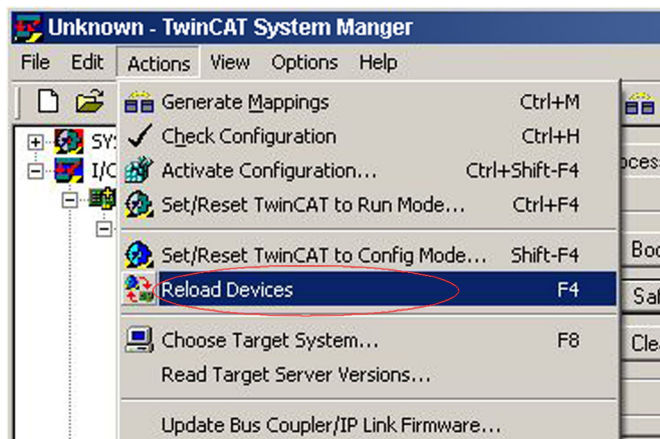

The selected measurement values are transmitted as process data in the status SAFEOP and OP.

| Name | Online | Type | Size | >Addr... | In/Out | User ID | Linked to |
|------------------------------|-------------------------|------------|------|----------|--------|---------|-----------|
| Intensity 1 | 0x00E203C0 (14812096) | UDINT | 4.0 | 26.0 | Input | 0 | |
| Distance 1 Ethernet/EtherCAT | 0x0133D7C2 (20174786) | UDINT | 4.0 | 30.0 | Input | 0 | |
| WcState | 0 | BOOL | 0.1 | 1522.0 | Input | 0 | |
| State | 0x0008 (8) | UINT | 2.0 | 1548.0 | Input | 0 | |
| AdsAddr | 00 00 00 00 00 00 E9 03 | AMSADDRESS | 8.0 | 1550.0 | Input | 0 | |

Local (10.26.16.169.192.168) Free Run

A 7.11 Finish EtherCAT

The sensor is in the Run mode; the EtherCAT/Ethernet LED is green.

➔ Choose the Actions > Start/Restart menu point of TwinCAT in config mode in TwinCAT Manager. Confirm the window Activate Free Run with No.

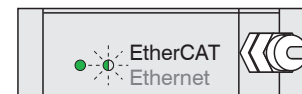
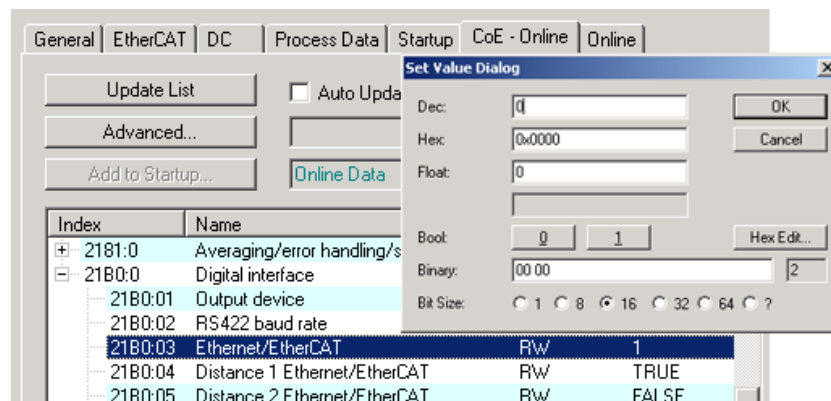

➔ Choose the 21B0:03 object and set the value of the parameter to 0.

➔ Confirm the dialog with OK.

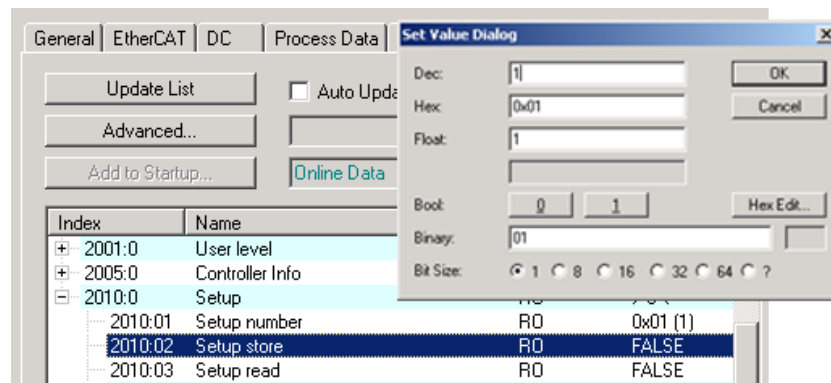

➔ Choose the 2010:02 object and set the value of the parameter to 1.

➔ Confirm the dialog with OK.

Therewith, save the settings.

➡ Finish the TwinCAT Manager.

The LED EtherCAT/Ethernet on sensor is off.

➡ Restart the sensor.

The LED EtherCAT/Ethernet on sensor is yellow.

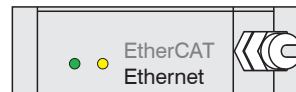

A 7.12 Troubleshooting

Initial situation: Sensor erroneously converted to EtherCAT.

Purpose: Enable Ethernet interface.

The TwinCAT-Manager program is installed, the device description file <optoNCDT2300.xml > is copied from the product-CD in the directory \\TwinCAT\IO\EtherCAT.

➡ Restart the sensor.

➡ Restart the TwinCAT-Manager

➡ Select the menu File > New.

➡ Select the tab I/O Devices, then Scan Devices.

➡ Confirm with OK.

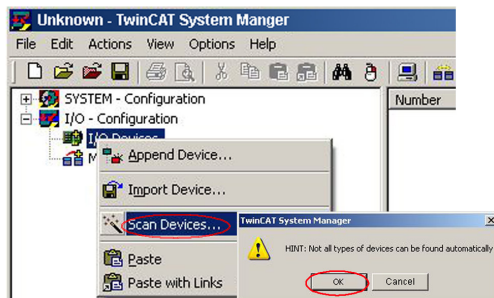

➡ Select a network card, where EtherCAT®-Slaves should be searching for.



➔ Confirm with OK.



It appears the window Scan for boxes (EtherCAT®-Slaves).

➔ Confirm with Yes.

The ILD 2300 is now shown in a list.

➔ Now confirm the window Activate Free Run with Yes.

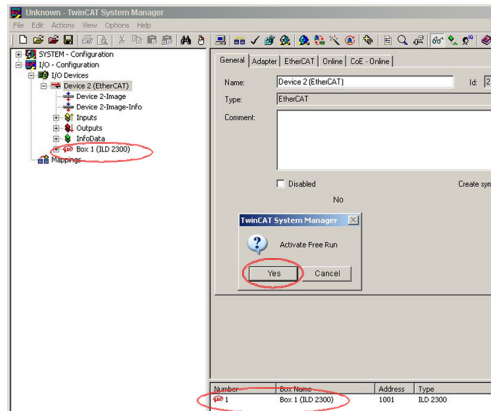

The current status should be at least PREOP, SAFEOP or OP on the Online side, see Chap. A 7.10.

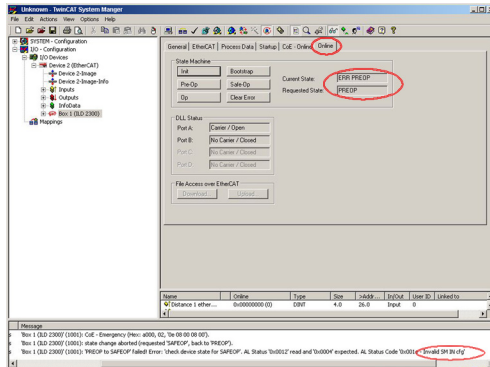

To configure the synchronous manager correctly, it is first necessary to read the object directory of ILD2300:

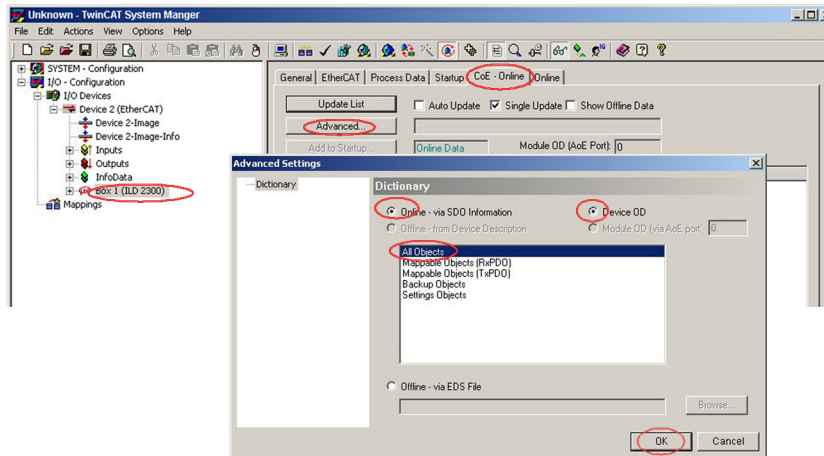

➡ Confirm with **OK**.

After reading the object directory:

The screenshot shows the TwinCAT System Manager interface. The left sidebar displays a tree view of the system configuration, including I/O Devices, Device 2 (EtherCAT), and its various components like Inputs, Outputs, InfoData, and Box 1 (ILD 2300). The main window displays the 'Object Directory' for the selected device, showing a list of objects with their indices, names, flags, and values.

| Index | Name | Flags | Value |
|----------|-------------------------------------|-------|---------------------|
| 1000 | Device type | RO | 0x00020000 (131072) |
| 1001 | Error register | RO | 0x00 (0) |
| + 1003.0 | Error history | RW | > 0 < |
| 1008 | Device name | RO | ILD2300 |
| 1009 | Hardware version | RO | V 4.076 |
| 100A | Software version | RO | V 4.104 |
| + 1018.0 | Identity | RO | > 4 < |
| + 1A00.0 | TxFDO | RO | > 1 < |
| + 1C00.0 | Sync manager type | RO | > 4 < |
| + 1C13.0 | TxFDO assign | RW | > 1 < |
| + 2001.0 | User level | RO | > 7 < |
| + 2005.0 | Controller info | RO | > 9 < |
| + 2010.0 | Setup | RO | > 5 < |
| + 2131.0 | Light source info | RO | > 2 < |
| 2154 | Measuring programme | RW | 0 |
| 2161 | Peak distance measurement selection | RW | 0 |
| + 2181.0 | Averaging/error handling/statistics | RO | > 11 < |
| + 2180.0 | Digital interfaces | RO | > 17 < |
| + 21C0.0 | Ethernet | RO | > 8 < |
| + 21E0.0 | Zeroing/Mastering | RO | > 5 < |
| + 2250.0 | Measuring rate | RO | > 4 < |
| + 2410.0 | Trigger mode | RO | > 10 < |
| + 2711.0 | ROI | RO | > 2 < |
| + 2800.0 | Material info | RO | > 3 < |
| + 2801.0 | Material selection | RO | > 2 < |
| + 2802.0 | Material table edit | RO | > 3 < |
| + 603F.0 | Sensor error | RO | > 2 < |
| + 60CE.0 | Material selection | RO | > 1 < |

Below the object directory, a table shows the properties of the selected object:

| Name | Online | Address | Type | Size | Address | In/Out | User ID | Linked to |
|---------------------|------------------------|------------|------|--------|---------|--------|---------|-----------|
| Distance 1 Ether... | 0x00599776 (5871...) | UDINT | 4.0 | 26.0 | | Input | 0 | |
| WcState | 0 | BOOL | 0.1 | 1522.0 | | Input | 0 | |
| State | 0x0008 (8) | UINT | 2.0 | 1548.0 | | Input | 0 | |
| AdsAddr | 00 00 00 00 00 00 E... | AMSADDRESS | 8.0 | 1550.0 | | Input | 0 | |

➡ Continue with the instructions for closing EtherCAT, see Chap. A 7.11.

A 8 Control Menu

| | | | |
|---------------------|------------------------------|---|------------------|
| Login, user level | Logged in as | <i>Value</i> | <i>Read only</i> |
| | Change user level | <i>Button Logout or password required</i> | |
| | Change password | Old password | <i>Value</i> |
| | | New password | <i>Value</i> |
| Repeat new password | | <i>Value</i> | |
| | User level upon switching on | <i>Professional / User</i> | |

| | | | |
|-------------------|-------------------------|--|--|
| Measuring program | Measurement arrangement | <i>Diffuse reflection /
Direct reflection distance measurement /
Direct reflection thickness measurement</i> | <i>Displacement measurement by diffuse reflection; Sensor evaluates the reflected stray light. Displacement or thickness measurement by direct reflection; Sensor evaluates the light, which is reflected at the target surface.</i> |
| | Peak to be measured | <i>first Peak /
highest Peak /
widest Peak</i> | <i>Defines, which signal is used for the evaluation in the line signal. First Peak: Nearest peak to sensor. Highest peak: Standard, peak with the highest intensity. Widest Peak: Signal with the largest area, use by small adjacent faults</i> |
| | Laser power | <i>full / reduced / off</i> | <i>Reduction of the laser power. Recommended for strongly reflective targets.</i> |
| | Material | <i>Selection from material data base</i> | <i>Material selection necessary for the thickness measuring program. The factory setting of the data base can be restored, if the factory setting is loaded. In the material data base up to 20 materials can be stored.</i> |

| | | | | | |
|---------------------------------------|---|--|-----------------------------|--|---|
| Measuring rate | 1.5 / 2.5 / 5 / 10 / 20 / 30 / 49,140 kHz | | | For dark or bright measuring objects a slower measuring rate may be required. The control may however expose no longer than the measuring rate allows. The measurement range of the sensor is reduced at 49,140 kHz. | |
| Averaging, error handling, statistics | Video averaging | No averaging / Recursive 2 / 4 / 8
Moving 2 / 3 / 4
Median 3 | | | Video averaging is effected before the calculation of the displacement or thickness. Recommended for very small peaks respectively to receive more valid data. |
| | Measurement averaging | No averaging | | | Indication of averaging mode. The averaging number N indicates the number of consecutive measurement values to be averaged in the sensor. |
| | | Moving N values | 2 / 4 / 8 ... 128 | Value | |
| | | Recursive N values | 2 ... 32768 | Value | |
| | | Median N values | 3 / 5 / 7 / 9 | Value | |
| | Error handling | Error output, no measurement value | | | Sensor emits error value. |
| | | Keep last value | 0 ... 1024 | Value | If no valid measurement value is determined, the last valid value can be hold for a certain period, that is, output repeatedly. The last valid value is kept indefinitely at „0“. |
| | | Keep last value infinitely | | | The last valid value is output indefinitely. |
| | Spike correction | No | | | |
| | | Yes | Evaluation length, 1 ... 10 | Value | This filter removes individual very high spikes from a relatively constant course of measurement value. Smaller spikes are preserved. |
| Max. tolerance range [mm], 0 ... 100 | | | Value | | |
| Number of correct value, 1 ... 100 | Value | | | | |

| | | | |
|---|---------------------------------|---|---|
| Averaging,
error handling,
statistics | Statistics | 2 / 4 / 8 / 16 ... 16384 / all measuring values | Beyond a certain number of measurement values the statistical values minimum, maximum and peak-to-peak are determined and output. |
| Mastering/Zeroing | Master value
in mm | Value | Data, for example of the thickness, of a master piece.
Value range max. - 2 x measuring range up to + 2 x measuring range |
| Material data base | Material | Value | Read only |
| | Input of material
parameters | Material name | Value |
| | | Material description | Value |
| | | n (refractive index) | Value |

| | | | | | | |
|--------------------|---------------------------------|--|-------------------|--|---|--|
| Digital interfaces | Selection of digital interfaces | <i>Web diagram / Ethernet measurement transmission / RS422</i> | | <i>Decides via the used interface for measurement output. A parallel measurement output via multiple channels is not possible.</i> | | |
| | Data selection | <i>Distance 1, 2 / Difference 1 to 2 / Statistics Min / Statistics Max / Statistics peak-to-peak / Exposure time / Intensity of distance value / Status / Measurement value counter / Time stamp / Trigger counter / Temperature</i> | | <i>The data which are provided for the transmission are to activate with the checkbox.</i> | | |
| | Ethernet settings | IP settings basic unit | Address type | <i>Static IP address / DHCP</i> | | |
| | | | IP address | <i>Value</i> | <i>Values for IP address / Gateway / Subnet mask. For static IP address only.</i> | |
| | | | Gateway | <i>Value</i> | | |
| | | | Subnet mask | <i>Value</i> | | |
| | | Settings of Ethernet measurement transmission | Transmission type | <i>Server TCP IP / Client TCP IP / Client UDP IP / no transfer</i> | | |
| | | | IP address | <i>Value</i> | <i>for Client TCP IP and Client UDP IP only</i> | |
| | Port | | <i>Value</i> | | | |
| RS422 settings | Baud rate | <i>9.6 / 115.2 / 230.4 / 460.8 / 691.2 / 921.6 / 1500 / 2000 / 2500 / 3000 / 3500 / 4000 kBps</i> | | | | |
| Ethernet/EtherCAT | Operation mode after start | <i>Ethernet / EtherCAT</i> | | | | |
| Output data rate | Every measured value | <i>Value</i> | | <i>Only every nth measurement value is output (n = 1, 2 ... 3.000.000). The other values are rejected.</i> | | |
| | Reduction interfaces | <i>RS422 / Ethernet</i> | | <i>The interfaces, which are provided for the sub-sampling, are to be selected with the checkbox.</i> | | |

| | | | | | | | |
|-----------------------------|----------------------|----------------------------|---|-------------------------------|-----------------------------------|---|--|
| Trigger mode | Selected mode | <i>Level triggering</i> | <i>Measurement value input
Measurement value output</i> | Measured value output at | <i>Low level / High level</i> | | |
| | | <i>Edge triggering</i> | <i>Measurement value input
Measurement value output</i> | Start measurement output with | <i>Falling edge / Rising edge</i> | | |
| | | | | Number of values | Value | „0“ stop triggering, „1 ... 16382“ values per triggering, „16383“ continuous triggering | |
| | | | | Number of values | Value | „0“ stop triggering, „1 ... 16382“ values per triggering, „16383“ continuous triggering | |
| | | <i>Software triggering</i> | <i>Measurement value input
Measurement value output</i> | Number of values | Value | „0“ stop triggering, „1 ... 16382“ values per triggering, „16383“ continuous triggering | |
| | <i>No triggering</i> | | | | | | |
| Termination Sync/Trig input | <i>Checkbox</i> | | <i>Checkbox activates the terminating resistor for line matching.</i> | | | | |

| | | | |
|-----------------|-----------------------------|----------------------------------|--|
| Synchronization | Synchronization mode | Master on | Use at simultaneous synchronization. Both sensors measure in the same cycle. Application: Measurement of differences (thickness, difference in height) on opaque objects. Here, Sensor 1 must be programmed as the "Master" and Sensor 2 as the "Slave". |
| | | Master on alternately / Slave in | Use at alternating synchronization. Both sensors measure alternately. Output rate \leq measuring rate / 2. Application: Thickness measurements on translucent objects or measurements of difference on closely spaced measurement points. The alternating synchronization requires that the lasers are switched on and off alternately so that the two sensors do not interfere with each other optically. Therefore one sensor is to program as "Master alternating" and one as "Slave". There can be only one master to be connected to a slave. |
| | | No synchronization | |
| | Termination Sync/Trig input | Checkbox | Checkbox activates the terminating resistor for line matching. |

| | | | |
|----------------------------|-------------------------|-----------------|---|
| Load /
save
settings | Setup no.: | 1 / 2 / 3 ... 8 | <i>Selection of the set of parameters to be load/save. The user selects a number when loading/saving a complete configuration. Allows fast duplicating of parameter sets.</i> |
| | Keep interface settings | Checkbox | <i>You should load the interface settings only when the sensor is operated on different networks respectively with different baud rates of the RS422 interface.</i> |
| | Activate | Button | <i>If you press Activate the upper selected parameter set is loaded from the internal memory of the sensor.</i> |
| | Save setup | Button | <i>The current sensor settings are stored in the selected parameter set in the internal memory of the sensor.</i> |

| | | | | |
|--------------------|---------------------------------|----------------------------|--|--|
| Load/save settings | Data selection for transmission | Setup / Material data base | | A parameter set contains settings for measuring, for example measuring rate and the interface settings. The material data base contains refractive indices of different materials. |
| | Setup no.: | 1 / 2 / 3 ... 8 | | Selection of the set of parameters to be load/save. The user selects a number when loading/saving a complete configuration. Allows fast duplicating of parameter sets. |
| | Export setup | Button | | If you press <code>Export</code> , the download manager of your browser opens and offers to save the setting values in a specified file "setup. meo" in the PC. |
| | Keep interface settings | Checkbox | | You should load the interface settings only when the sensor is operated on different networks respectively with different baud rates of the RS422 interface. |
| | Browse / Import | Button | | If you press <code>Browse . . .</code> Windows opens the selection window to select a configuration file saved in the PC. By opening the selected file in the selection window, the path is cached. Loading the file will be effected by the <code>Import</code> button. |

| | | | | |
|--------|-----------------|-------------------------------|------------------|--|
| Extras | Language | | German / English | Language of the interactive websites. |
| | Unit | | mm / inch | Units in the measurement representation |
| | Factory setting | Reset material data base only | Checkbox | Allows to replace only the values in the material database. |
| | | Keep interface settings | Checkbox | This enables to leave all the settings for the Ethernet and the RS422 interface unchanged. |

 Selection required or checkbox

 Specification of a value required

i The settings will be effective, if you click on the button `Apply`. After the programming, all settings must be permanently stored under a parameter set, so that they are available again when the sensor is switched on the next time.

A 9 Measuring Value Format Ethernet

An Ethernet measuring value frame is built up dynamically, i.e. not selected values are not transferred.

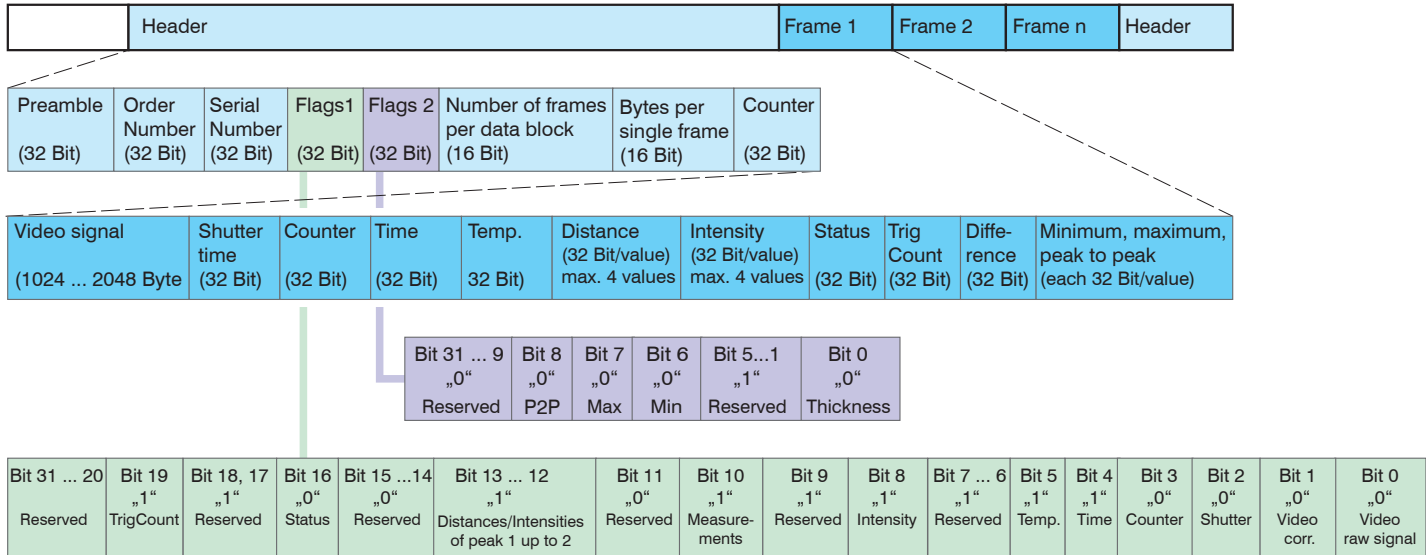

Fig. 63 Example for a data transmission with Ethernet

You will find further information in the Ethernet range, see Chap. 8.2.



MICRO-EPSILON MESSTECHNIK GmbH & Co. KG
Königbacher Str. 15 · 94496 Ortenburg / Germany
Tel. +49 (0) 8542 / 168-0 · Fax +49 (0) 8542 / 168-90
info@micro-epsilon.de · www.micro-epsilon.com

X9751234-C061047HDR
© MICRO-EPSILON MESSTECHNIK

