



Good Thinking, Good Future

*FASTUS is a product brand of Optrix FA.

Through-beam Edge Sensor TD1 Series

User's manual

Before using this product, please read this manual carefully.
Keep this manual at hand so that it can be used whenever necessary.
Store the manual in a safe location.



OPTEX FA CO., LTD.

Introduction



Thank you for purchasing the **TD1 series Through-beam Edge Sensor**.

This manual contains the information necessary for using the **TD1 series Through-beam Edge Sensor**.

Read this manual thoroughly before using the product to ensure correct product use with full understanding of the functions and performance of the product. Also, after you have finished reading this manual, store it safely for future reference.

- Trademarks and registered trademarks appearing in this manual are the property of their respective owners.
- The copyright of this user's manual is owned by OPTEX FA CO., LTD. All the contents contained herein are protected by copyright law. Unauthorized copying of this manual is strictly prohibited.



Safety Precautions

This manual uses the following symbols to display safety precautions for ensuring safe operation of the TD1 series of through-beam edge sensors.











Precautions listed here describe important information about safety. Make sure to follow them accordingly.

■ Safety Symbols



The safety symbols and their meanings are as follows.

 Warning	Indicates that any improper operation or handling may result in moderate or minor injury, and in rare cases, serious injury or death. Also indicates a risk of serious property damage.
 Caution	Indicates that any improper operation or handling may sometimes result in moderate or minor injury or property damage.











■ Notes

 Warning	
	This product cannot be used as protective equipment for the purpose of protecting the human body.
	Do not disassemble, repair, modify, deform under pressure, or attempt to incinerate this product. Doing so may cause injury or fire.
	Do not use this product in water or in a location where it may be exposed to water. Do not use this product if wet. Doing so may cause a fire or damage the product.
 	This product is not explosion-proof and should not be used around flammable or explosive gases or liquids. Doing so may cause ignition resulting in an explosion or fire.
 	Do not use air dusters or any spray that uses flammable gas around the product or on the inside of the product. Doing so may cause ignition resulting in an explosion or fire.
	Do not install this product or its cables in any of the following locations. Doing so may cause a fire, damage, or a malfunction. <ol style="list-style-type: none"> 1. Locations where dust, salt, iron powders, or vapor (steam) is present. 2. Locations subjected to corrosive gases or flammable gases. 3. Locations where water, oil, or chemical splashes may occur. 4. Locations where heavy vibrations or impacts may occur. 5. Locations where the ambient temperature exceeds the rated range. 6. Locations subject to rapid temperature changes (or where condensation occurs). 7. Locations with strong electric or magnetic fields. 8. Outdoor locations or locations subject to direct light.
	Do not use the product at voltages or with AC power supplies that exceed the rated voltage. Doing so may cause a fire or damage the product.



Warning

	<p>What to do in the event of a malfunction such as smoke being emitted from the product</p> <p>If you detect any malfunction including emission of smoke, abnormal smells or sounds, or the body becoming very hot, immediately stop operating the product and turn off the power. Doing so may cause a fire.</p> <p>Repairing the product is dangerous and should in no way be performed by the customer. Contact an OPTEX FA sales representative for repairs.</p>
	<p>What to do if water enters the product</p> <p>If water or any other liquid enters the product or the cable, immediately stop operating the product and turn off the power. Using the product in this condition may cause a fire.</p>

Caution

	Do not touch the product or the cable with wet hands. Doing so may damage the product.
	Follow the instructions in this manual or the specified instruction manual when wiring the product or the dedicated controller for the correct wiring method. Incorrect wiring can damage the product or the controller, or cause a malfunction.
	Use the dedicated cable for connecting the product. Use of anything other than the dedicated cable may cause a malfunction or damage the product.
	Route wiring separately from high-voltage circuits and power circuits. If the wires are routed together, induction may occur, which can cause a malfunction or damage the product. If this is unavoidable, use a conductive object such as a properly grounded conduit as a shield.
	Install this product as far away from high-voltage equipment, power equipment, equipment that generates large switching surges, welders, inverter motors, or any equipment that can be a source of noise.
	Install the product and the dedicated controller securely. Ensure that any lock mechanisms available have been locked before use. Failure to ensure secure installation can result in the product falling and becoming damaged.
	Tighten mounting screws to the torque specified in this manual.
	Do not twist or apply stress to the cable. Doing so may damage the cable or the connector. In addition, install the cable while ensuring that the minimum bend radius or more is secured.
	Do not drop the product or subject the product to strong impacts. Doing so may damage the product.
	During operation, this product becomes very hot. Do not touch it for long periods of time. Doing so may cause a low-temperature burn.
	Use the product and dedicated controller within the rated ranges.

Caution

	Make sure to turn the power off before connecting or disconnecting the cable. Connecting or disconnecting while energized may damage the product.
	When connecting the cable, make sure to hold it by the connector portion, and do not apply excessive force to the cable.
	When disconnecting the connector, be careful not to touch the terminals inside the connector, and do not allow foreign objects to enter the connector.

■ Handling Precautions

1. After carefully considering the intended use, required specifications, and usage conditions, install and use the product within the specified ranges.
2. Due to advances in technology, published content, including the hardware, software, and system information published in this user's manual are subject to change without notice.
3. When using this product, it is the responsibility of the customer to ensure necessary safety designs in hardware, software, and systems in order to prevent any threat to life, physical health, and property due to product malfunction or failure.
4. This product is not intended for use with nuclear power, railways, aviation, vehicles, medical equipment, food-handling equipment, or any application where particular safety measures are required. Absolutely do not use this product for any of these fields.
5. This product cannot be used in applications that directly or indirectly detect human bodies for the purpose of ensuring safety. Do not use this product as a detection device for protecting the human body.
6. Do not use this product for the development of weapons of mass destruction, for military use, or for any other military application. Moreover, if this product is to be exported, comply with all applicable export laws and regulations, including the "Foreign Exchange and Foreign Trade Act" and the "Export Administration Regulations," and carry out the necessary procedures pursuant to the provisions therein.
7. For more details on conformity to the Restriction of Hazardous Substances Directive for this product, please contact an Optex FA sales representative.

Before using this product, fully examine the applicable environmental laws and regulations, and operate the product in conformity to such laws and regulations.

Optex FA does not assume any responsibility for damages or losses occurring as a result of noncompliance with applicable laws and regulations.

■ Precautions for Laser Use

Caution

- This product emits a Class 1 visible laser beam that is compliant with JIS C6802 / IEC60825-1 laser safety standards.
- If this product will be exported to the United States, approval must first be obtained from the FDA (Food and Drug Administration), the laser regulating body of the United States.
- A report for this product has been submitted to the CDRH (Center for Devices and Radiological Health).
- Do not look directly at the laser beam or intentionally shine the laser beam in another person's eyes. Doing so may have adverse effects on the eyes, including temporary blindness.
- If installing this product in your own equipment, ensure that the product is properly handled according to the laws and regulations of the relevant country or region.
- This product does not have a function that stops the emission of light from the laser during disassembly. Do not disassemble the product.

Contents

.....

Introduction	1
Safety Precautions	2
1 Configuring the Settings	7
2 Included Items / Optional Accessories	8
2.1 Included Items	8
2.2 Optional Accessories (Sold Separately)	9
3 Specifications	10
4 Dimensions	11
5 Connecting TD1 Series to CDA Series / Mounting..	12
5.1 Connecting.....	12
5.2 Mounting	12
5.3 Light Axis Adjustment.....	14
5.4 Direction Checking (Light Axis Checking, Simple Adjustment)	15
5.5 Light Axis Checking (Simplified)	17
6 Measurement Type Setting.....	18
6.1 Edge Measurement and Width/Gap Measurement	18
6.2 Switching Between Edge Measurement and Width/Gap Measurement.....	19
7 Measurement Polarity Setting.....	20
7.1 Measurement Polarity Options	20
7.2 Measurement Polarity Setting.....	21
8 Measuring Transparent Objects	22
8.1 Sensitivity Adjustment For Transparent Objects.....	22
8.2 Measurement Direction Setting	23

9	Zero Teaching	25
9.1	Zeroing.....	25
9.2	Zeroing.....	27
9.3	Checking/Resetting Zeroing Value	28
10	Setting Channel 2 to Not Be Used	29
10.1	Checking the PWR Indicator.....	29
10.2	Setting Channel 2 to Not Be Used.....	29
11	Setting Menu Overview.....	30
12	CDA Series (Amplifier) Output Settings.....	32
12.1	No. and Types of Control Outputs	32
12.1.1	Control Output Setup Procedure.....	34
12.1.2	Control (Upper/Lower) Output Settings	35
12.2	Analog Output Settings.....	39
12.2.1	Analog Scaling Settings	40
12.2.2	Analog Output Specifications	41
13	CDA Series Calculation	42
13.1	Mounting and Measurement Polarity	42
13.2	Calculation Settings.....	43



1 Configuring the Settings

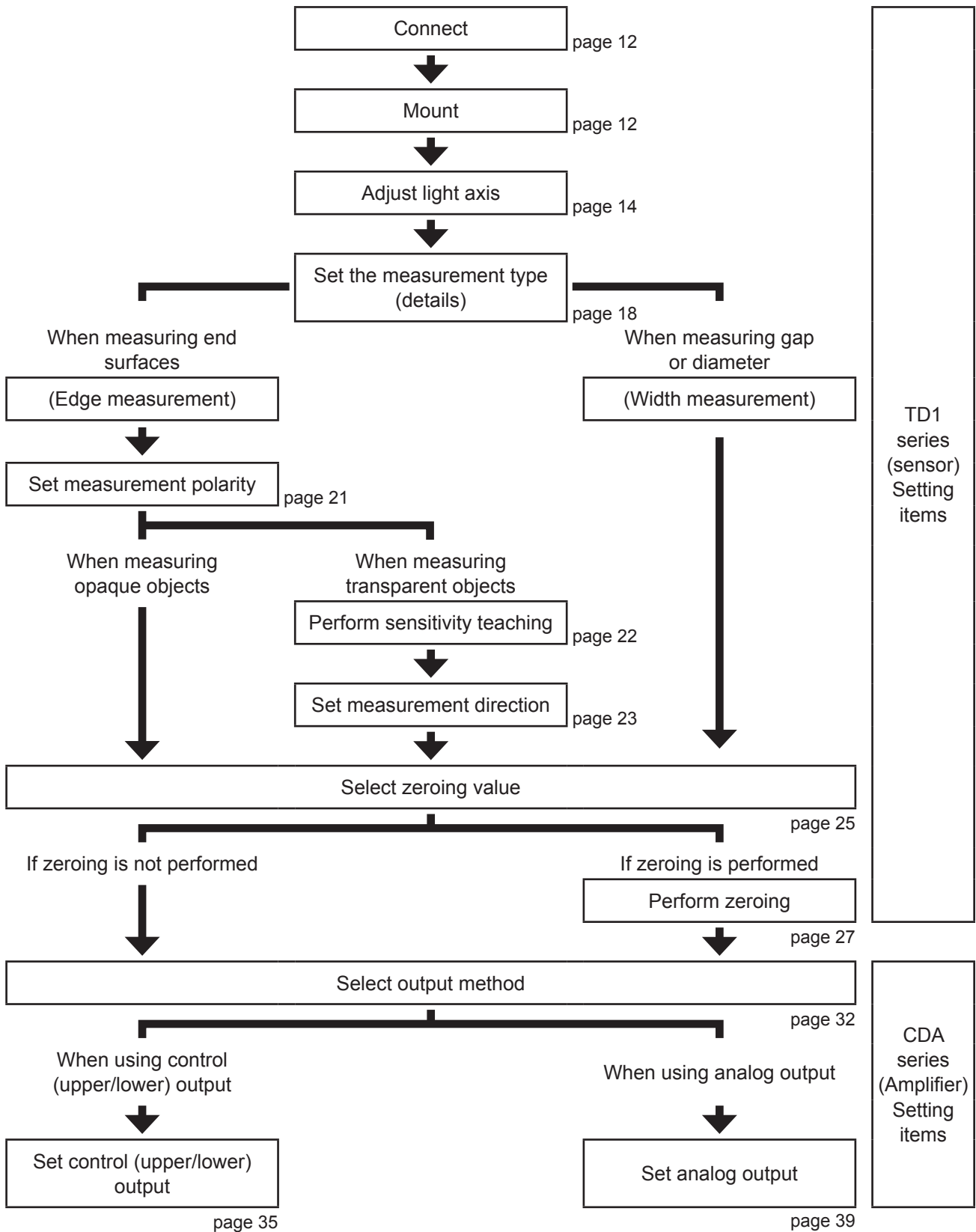

2 Included Items / Optional Accessories

2.1 Included Items

Before using this product, confirm that the following items are contained in the package.

TD1 sensor head emitting part and receiving part ×1 each

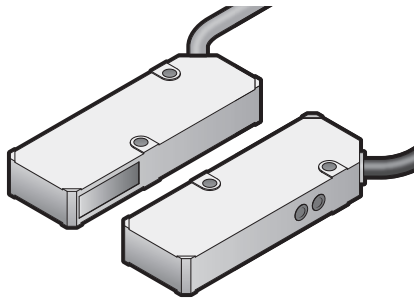

Sensor/amplifier connection cable (Y branch cable) ×1

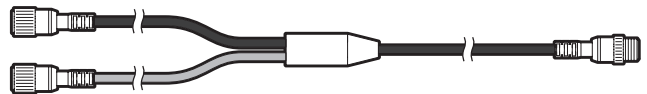

Instruction Manual ×1

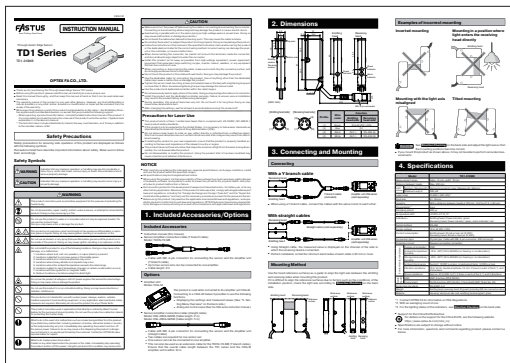

2.2 Optional Accessories (Sold Separately)

- CDA series amplifier unit

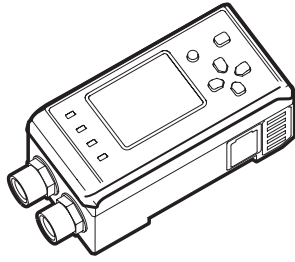

This product is used while connected to a CDA series amplifier unit. Connecting to a CDA series product makes it possible to use the following functions.

- Displaying various settings and measured values
- Analog output and control output

- Sensor/amplifier connection cable (straight connector)

DSL-0804-G02M (2 m robot cable)

DSL-0804-G05M (5 m robot cable)



- The cable features an M8, 4-pin connector for connecting the sensor and the amplifier unit.
- The included Y branch cable can also be used for extension.
- Ensure that the overall cable extension length between the TD1 series and the amplifier unit is no more than 10 m.

3 Specifications

Model		TD1-010M8
Measurement range		Edge: ±5 mm, Width: 10 mm
Distance between heads		Max. 300 mm
Light source	Medium / Wavelength	Red semiconductor laser / 660 nm
	Maximum output	390 µW
Laser class		Class 1 (IEC/JIS/FDA ^{*1})
Spot size		3 × 14 mm
Linearity		With a distance between heads of 100 mm: ±0.4% of F.S. (±40 µm)
Repeatability ^{*2}		4 µm
Sampling period		500 µs
Temperature drift		±0.02% of F.S./°C
Indicators ^{*3}		[Emitting head] Power indicator: Green [Receiving head] Power indicator: Green, Alarm indicator: Red
Serial interface		RS-485
Supply voltage		12 to 24 VDC ±10%
Current consumption		Emitting head: 20 mA or less (at 12 VDC) Receiving head: 80 mA or less (at 12 VDC)
Connection type		Pig-tail cable with M8 4-pin connector, 300 mm length
Protection circuit		Reverse connection protection
Environmental resistance	Degree of protection	IP50
	Ambient temperature/humidity	-10 to +50°C / 35 to 85% RH (no freezing or condensation)
	Storage temperature/humidity	-20 to +60°C / 35 to 85% RH (no freezing or condensation)
	Ambient illuminance	Sunlight: 10,000 lx or less, Incandescent lamp: 3,000 lx or less
	Vibration resistance	10 to 55 Hz; double amplitude 1.5 mm; 2 hours in each of the X, Y, and Z directions
	Shock resistance	Approx. 50 G (500 m/s ²), 3 times in each of the X, Y, and Z directions
Applicable regulations	EMC	EMC directive (2014/30/EU)
	Environment	RoHS directive (2011/65/EU), China RoHS (Order No. 32)
Applicable standards		EN 60947-5-2
Weight		Emitting head, receiving head: Approx. 30 g (including 300 mm connector cable)
Material		Housing: Aluminum die cast, Emitting/receiving part: Glass

*1. In accordance with the FDA provisions of Laser Notice No. 50, the laser is classified as Class 1 per the IEC 60825-1:2007 standard.

*2. With a moving average of one.

*3. For the lighting status of the indicators, see page 15.

4 Dimensions

TD1-010M8

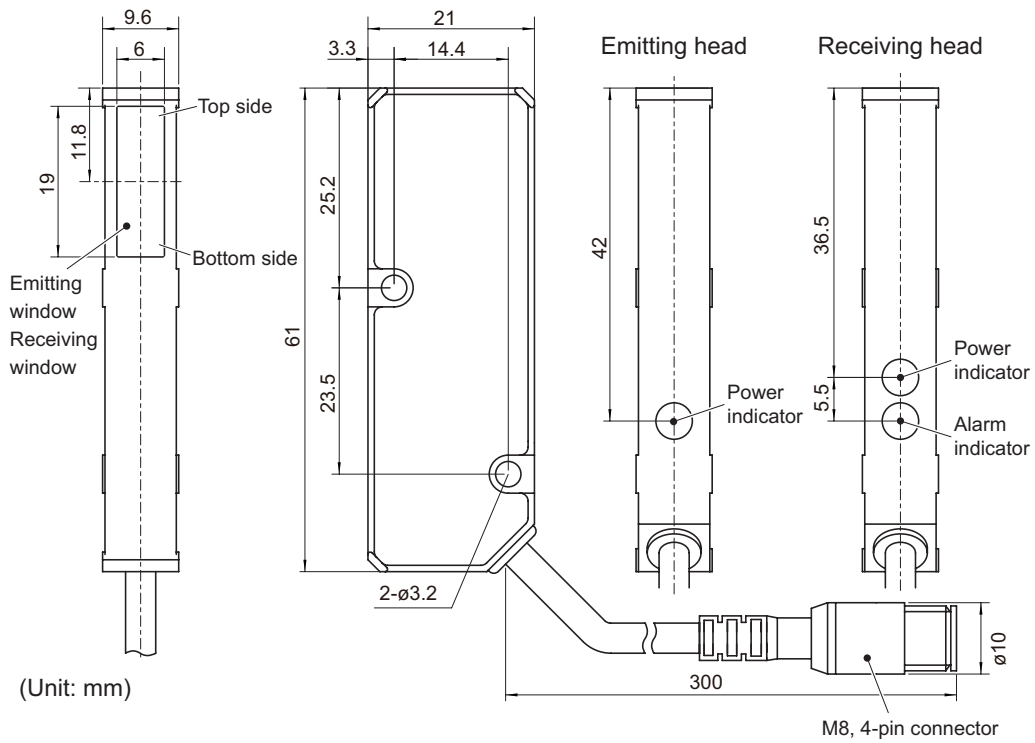

Connector pin layout

[Emitting head side] [Receiving head side]

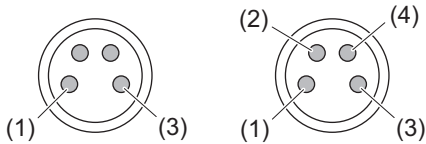

Pin No.	Wire color	Function	
		Emitting head side	Receiving head side
(1)	Brown	12 to 24 VDC \pm 10%	
(3)	Blue	0 V	
(4)	Black	(N.C.)	RS-485 (A)
(2)	White	(N.C.)	RS-485 (B)

5 Connecting TD1 Series to CDA Series / Mounting

This chapter explains how to connect a TD1 series sensor head to a CDA series amplifier, and how to mount the product.

5.1 Connecting

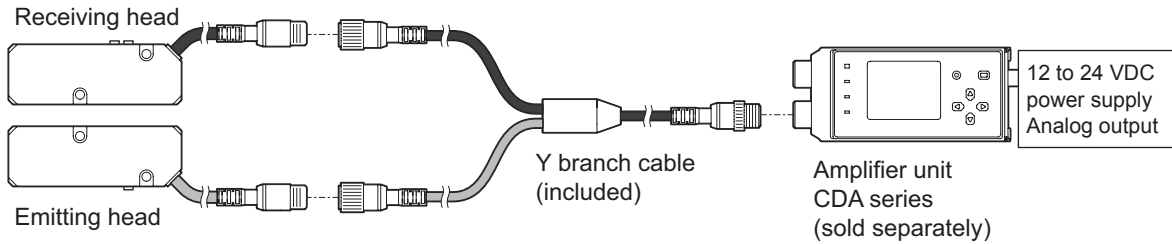

- Be sure to connect the Y branch cable to the same color of cable from the sensor head.
- A gray cable is used for the emitting head, and a black cable is used for the receiving head.

5.2 Mounting

A reference surface is set within the sensor head housing. Install the head vertically or horizontally based on this reference surface.

Correct measurement will not be possible if the product is not mounted in alignment with the reference surface.

Place the sensor heads no more than 300 mm apart.

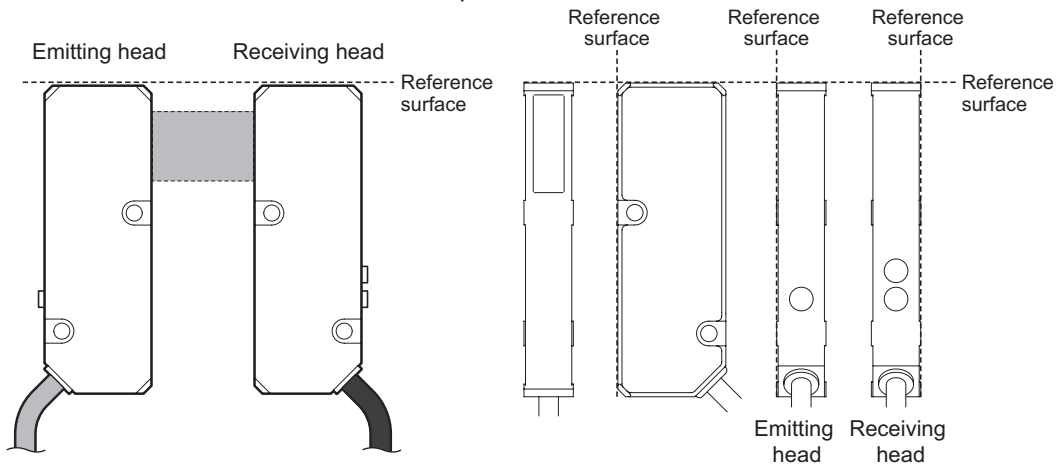

Caution

The following are examples of incorrect mounting.

Inverted mounting

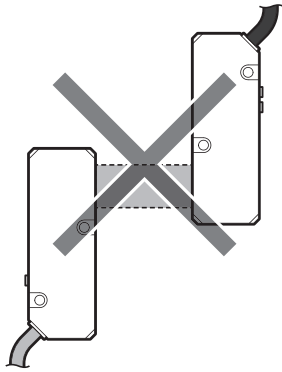

Mounting in a position where light enters the receiving head directly

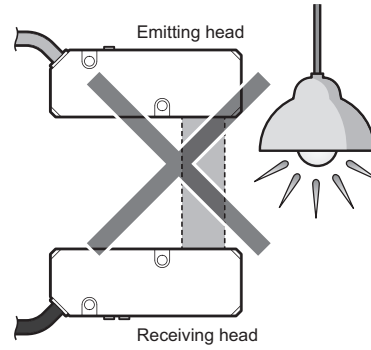

Mounting with the light axis misaligned

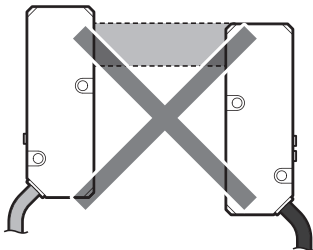

Tilted mounting

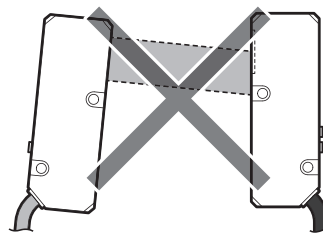

- Mounting the product as shown above may prevent accurate measurements from being possible.

5.3 Light Axis Adjustment

When mounting is difficult due to the reference surface, easily check the light axis using Direction Checking mode.

■ Direction Checking Mode Configuration

For a complete list of the setting menu options, see “11 Setting Menu Overview” (page 30).

- 1 Select the channel for which the settings will be changed.**
Press the up or down button to select a channel, and then press the A button.
- 2 Select “Setup mode.”**
Press the up button.
- 3 Press the left or right button to select “Direction Checking.”**
- 4 Switch direction checking to “ON.”**
Press the down button to select “ON,” and then press the A button.

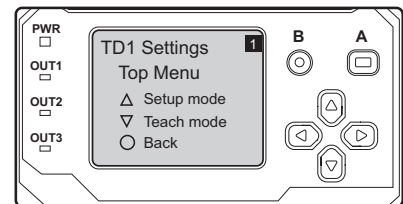
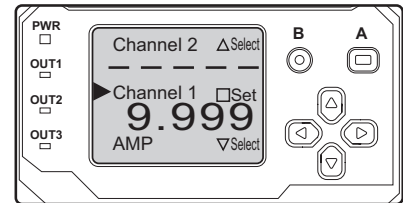

Direction Checking

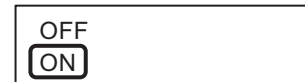

5.4 Direction Checking (Light Axis Checking, Simple Adjustment)

Direction Checking mode makes it possible to check and adjust for deviation of the light axis toward the top or bottom by turning on, flashing, and turning off the indicator during mounting. This function is used to check whether all of the light is being received.

● Correct reception of light

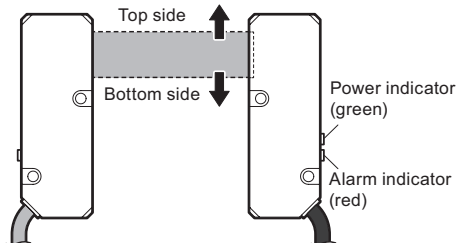

Display Power indicator (green): Lit continuously
Alarm indicator (red): Lit continuously

Status Light received correctly

● No light received

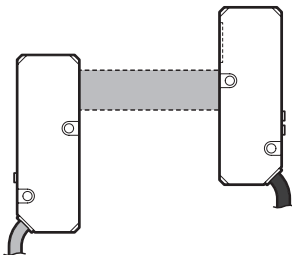

Display Power indicator (green): Not lit
Alarm indicator (red): Not lit

Status No light received

Countermeasure Confirm position of emitted light using a white paper, and align light axes as closely as possible

● Misaligned to the top side

The power indicator (green) on the receiving head side lights continuously, and the alarm indicator (red) flashes or turns off.

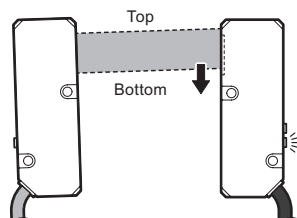

Display Power indicator (green): Lit continuously
Alarm indicator (red): Flashing quickly

Status Misaligned slightly toward top

Countermeasure Move light axis toward bottom

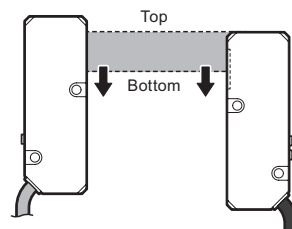

Display Power indicator (green): Lit continuously
Alarm indicator (red): Not lit

Status Only about half the light is received on top

Countermeasure Move light axis toward bottom

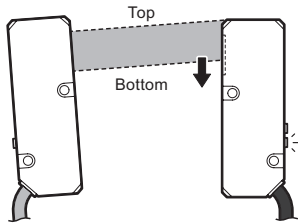

Display Power indicator (green): Lit continuously
 Alarm indicator (red): Flashing slowly
Status Misaligned toward top
Countermeasure Move light axis toward bottom

● Misaligned to the bottom side

The alarm indicator (red) on the receiving head side lights continuously, and the power indicator (green) flashes or turns off.

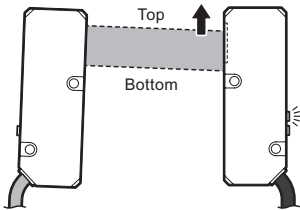

Display Power indicator (green): Flashing quickly
 Alarm indicator (red): Lit continuously
Status Misaligned slightly toward bottom
Countermeasure Move light axis toward top

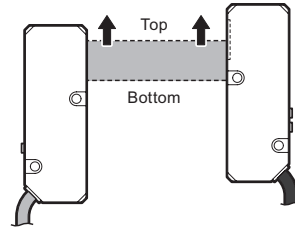

Display Power indicator (green): Not lit
 Alarm indicator (red): Lit continuously
Status Only about half the light is received on bottom
Countermeasure Move light axis toward top

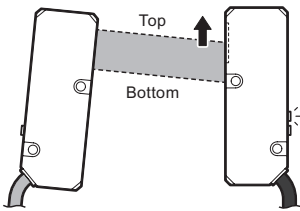

Display Power indicator (green): Flashing slowly
 Alarm indicator (red): Lit continuously
Status Misaligned toward bottom
Countermeasure Move light axis toward top

- After completing adjustment of the light axis, switch direction checking to “OFF.”

5.5 Light Axis Checking (Simplified)

With direction checking set to "OFF," return to the measurement screen. If "9999" is displayed inverted with no measurement target, all of the light is being detected.

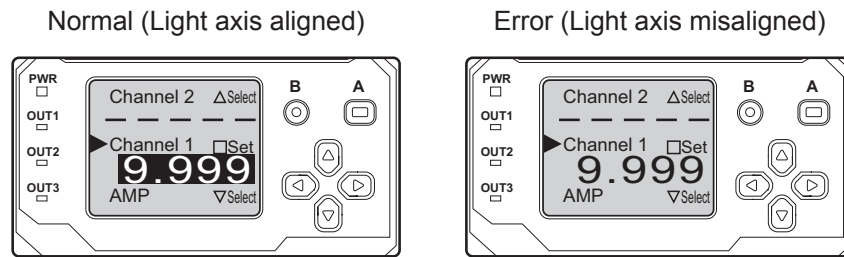

* Any number other than 9999 on the inverted display indicates an error.

6 Measurement Type Setting

6.1 Edge Measurement and Width/Gap Measurement

The TD1 Series is capable of two types of measurement: “Edge” (single edge measurement) and “Width” (width or gap measurement).

- **To measure the edge of the target**

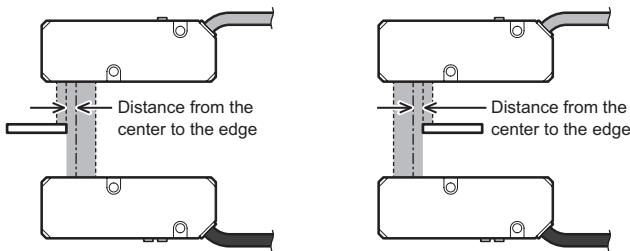

The displacement from the center of the light axis for a single edge is measured. The target insertion direction can be set to either Top or Bottom. Measurement cannot be performed if two or more edges exist within the measurement range.

- **To measure the target width or the gap between targets**

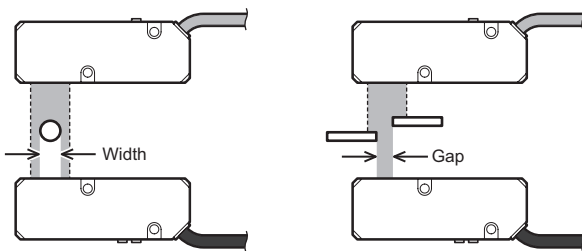

The distance between two edges will be measured. You can measure either the target width or the gap between two targets. Measurement cannot be performed if only one edge exists or three or more edges exist within the measurement range.

6.2 Switching Between Edge Measurement and Width/Gap Measurement

Edge measurement is set by default.

■ Setting the Measurement Type

For a complete list of the setting menu options, see “11 Setting Menu Overview” (page 30).

- 1 Select the channel for which the settings will be changed.**
Press the up or down button to select a channel, and then press the A button.

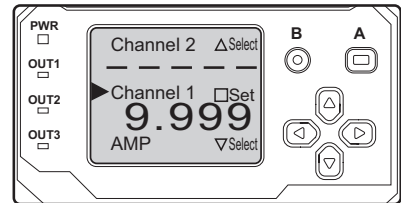

- 2 Select “Setup mode.”**
Press the up button.

- 3 Use the left or right button to select “Measure Type.”**

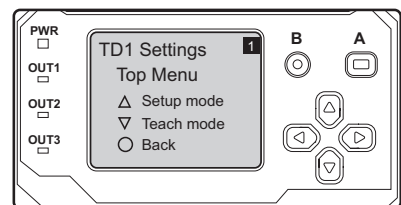

- 4 Change the measurement type.**

- **When measuring the edge of an end surface**
Select “Edge” for edge measurement.
- **When measuring the gap or width**
Select “Width” for width or gap measurement.

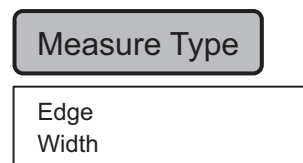

Press the up or down button to change the measurement type, and then press the A button.

7 Measurement Polarity Setting

Select whether to set the top side to -5.000 mm and the bottom side to +5.000 mm or vice-versa when measuring edge positions.

The "Measure polarity" setting is only enabled during "Edge" measurement.

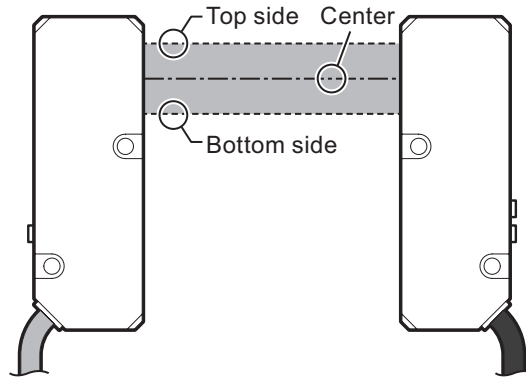

7.1 Measurement Polarity Options

The "Measure polarity" setting can be set to either "Positive" or "Negative." "Positive" is set by default.

Values when "Positive" is selected: Top side: -5.000 mm, Bottom side: +5.000 mm, Center: 0 mm

Values when "Negative" is selected: Top side: +5.000 mm, Bottom side: -5.000 mm, Center: 0 mm

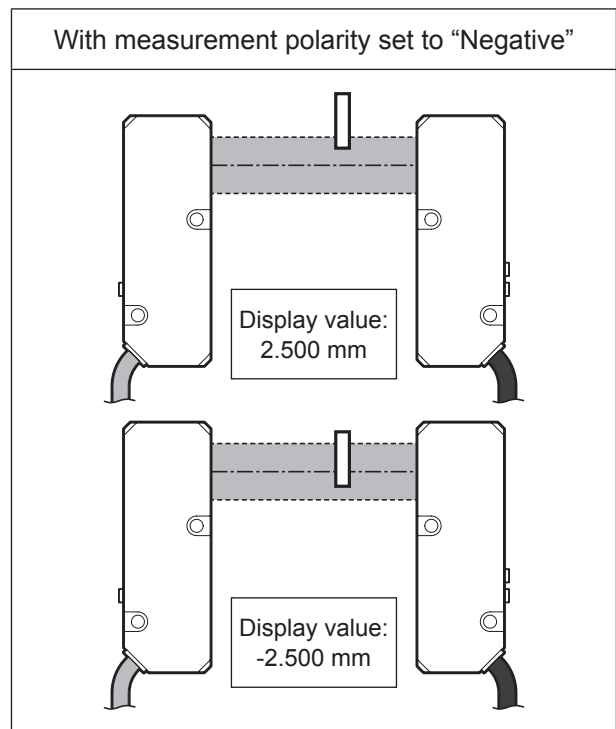
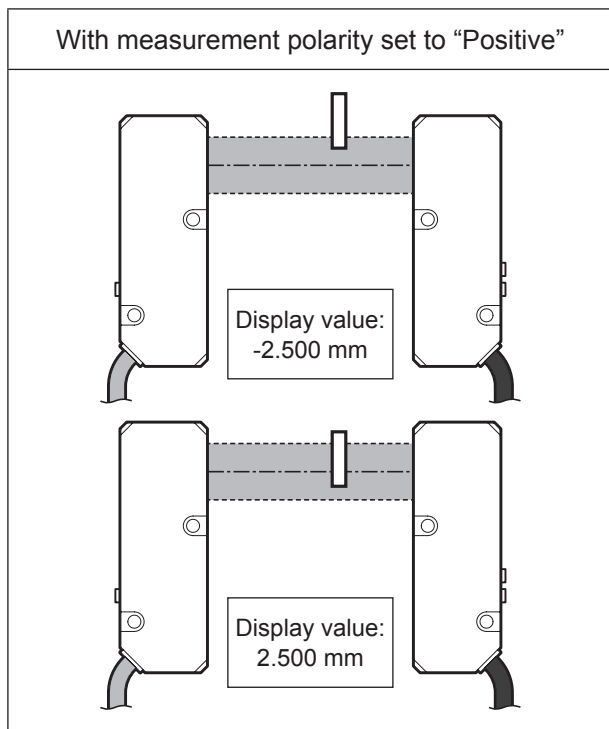

7.2 Measurement Polarity Setting

This section explains how to set “Measure polarity” to “Positive” or “Negative.”

■ Setting Measurement Polarity

For a complete list of the setting menu options, see “11 Setting Menu Overview” (page 30).

- 1 Select the channel for which the settings will be changed.**
Press the up or down button to select a channel, and then press the A button.

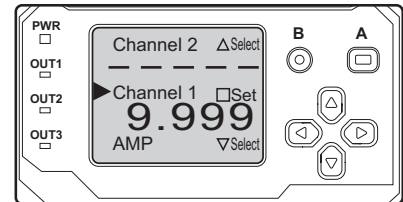

- 2 Select “Setup mode.”**
Press the up button.

- 3 Use the left or right button to select “Measure polarity.”**

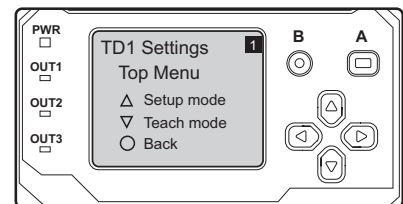

- 4 Change the measurement polarity.**

- **Setting “Measure polarity” to “Positive”**
Select “Positive” for the measurement polarity.
- **Setting “Measure polarity” to “Negative”**
Select “Negative” for the measurement polarity.

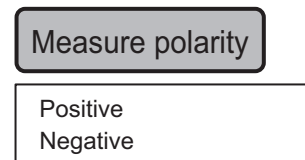

Press the up or down button to change the measurement polarity, and then press the A button.

* “Positive” is set by default.

8 Measuring Transparent Objects

8.1 Sensitivity Adjustment For Transparent Objects

This function is useful when the measurement target has a high transmittance and the measurement is not stable with preset “sensitivity” values. Set the sensitivity setting to “Adjusted,” and then perform translucent teaching. “Adjusted” can only be selected for edge measurement. This option cannot be selected for gap/width measurement.

■ Setting for Transparent Objects

For a complete list of the setting menu options, see “11 Setting Menu Overview” (page 30).

- 1 Select the channel for which the settings will be changed.**
Press the up or down button to select a channel, and then press the A button.
- 2 Select “Setup mode.”**
Press the up button.
- 3 Select “Sensitivity.”**
Use the left or right button to select “Sensitivity.”
- 4 Select “Adjusted.”**
Press the up or down button to select “Adjusted,” and then press the A button.
- 5 Go back to the TD1 series Top Menu.**
Press the B button.
- 6 Select “Teach mode.”**
Press the down button.
- 7 Use the left or right button to select “Translucent Teach.”**
- 8 Execute Teaching.**
With no measurement target being used and with “Translucent Teach” selected, press the A button.

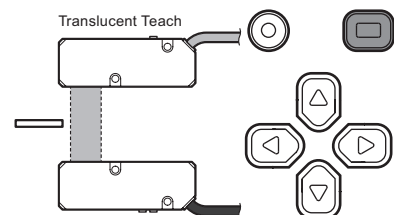
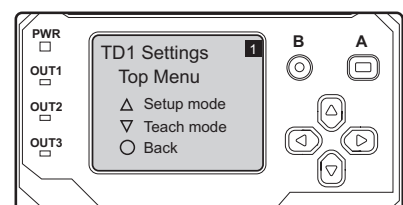
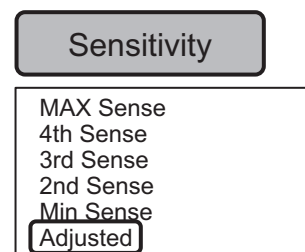
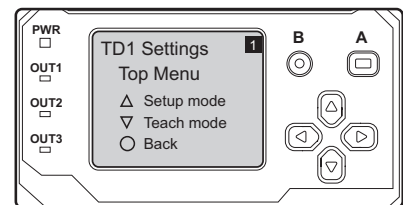
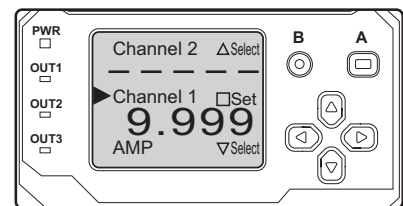

Caution

Following translucent teaching (after pressing the A button), the optimum sensitivity will be applied.

However, detection may not be possible in the case of highly transparent objects.

* Even though no completion message will be displayed, the settings will be applied when the A button is pressed.

8.2 Measurement Direction Setting

When setting sensitivity to "Adjusted," setting the insertion direction of the workpiece is required.

- **Inserting a measurement target from the top**

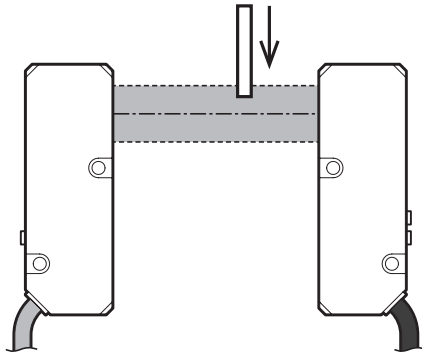

- **Inserting a measurement target from the bottom**

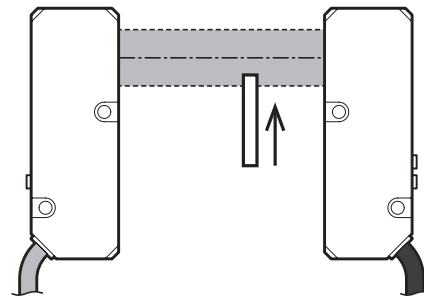

The default setting is for measurement to be performed for targets inserted from the top.

■ Setting Measurement Direction

For a complete list of the setting menu options, see “11 Setting Menu Overview” (page 30).

- 1 Select the channel for which the settings will be changed.**

Press the up or down button to select a channel, and then press the A button.

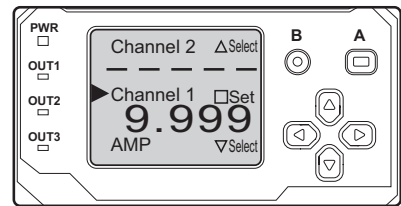

- 2 Select “Setup mode.”**

Press the up button.

- 3 Use the left or right button to select “Measure Direction.”**

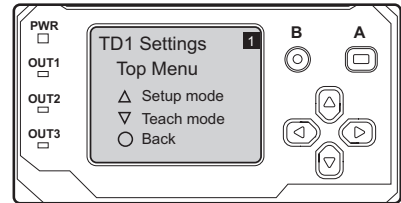

- 4 Select “Measure Direction.”**

- **When inserting a measurement target from the top**

Select “Top” for the measurement direction.

- **When inserting a measurement target from the bottom**

Select “Bottom” for the measurement direction.

Press the up or down button to change the measurement direction, and then press the A button.

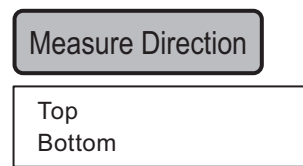

9 Zero Teaching

9.1 Zeroing

The measurement center position can be set (offset) to any position. This zeroing function is useful for checking the displacement amount from the reference position.

● Edge measurement

Measurement value when "Measure polarity" is set to "Positive":

Top side: -5.000 mm

Bottom side: +5.000 mm

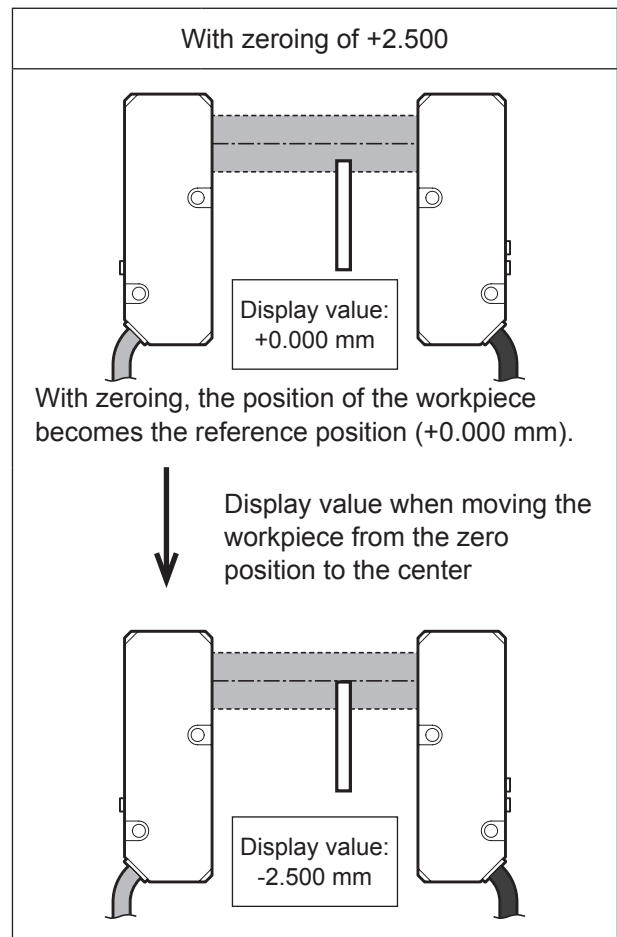
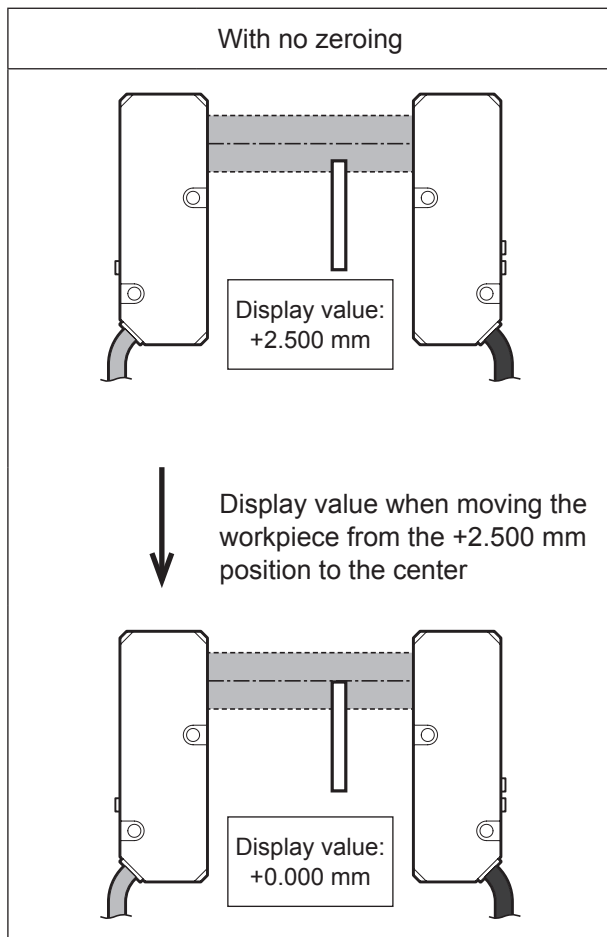

● Width/gap measurement

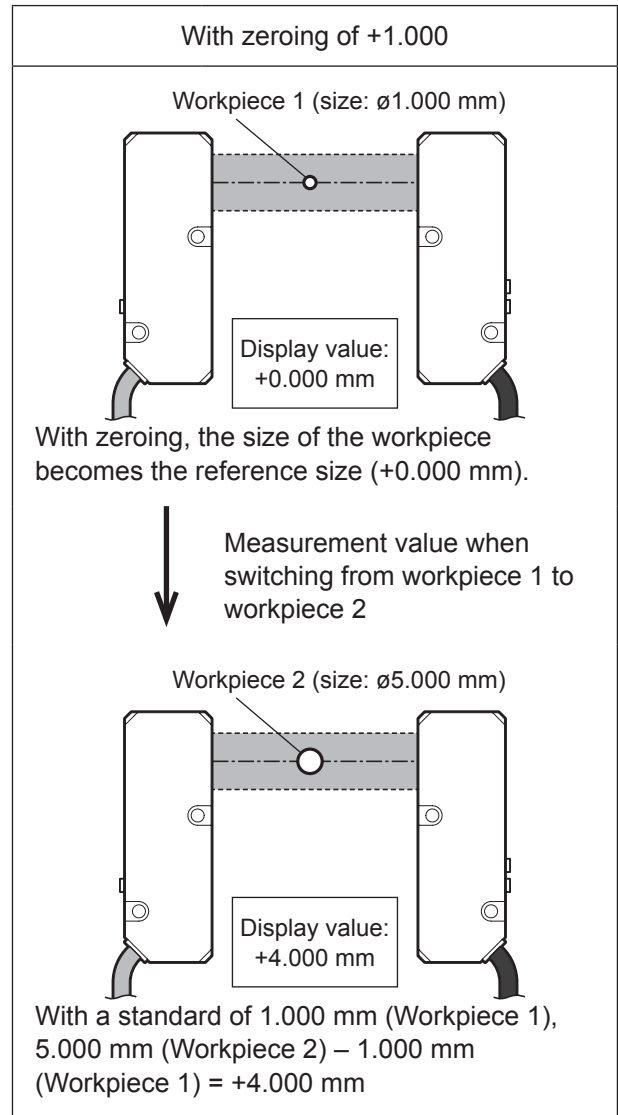
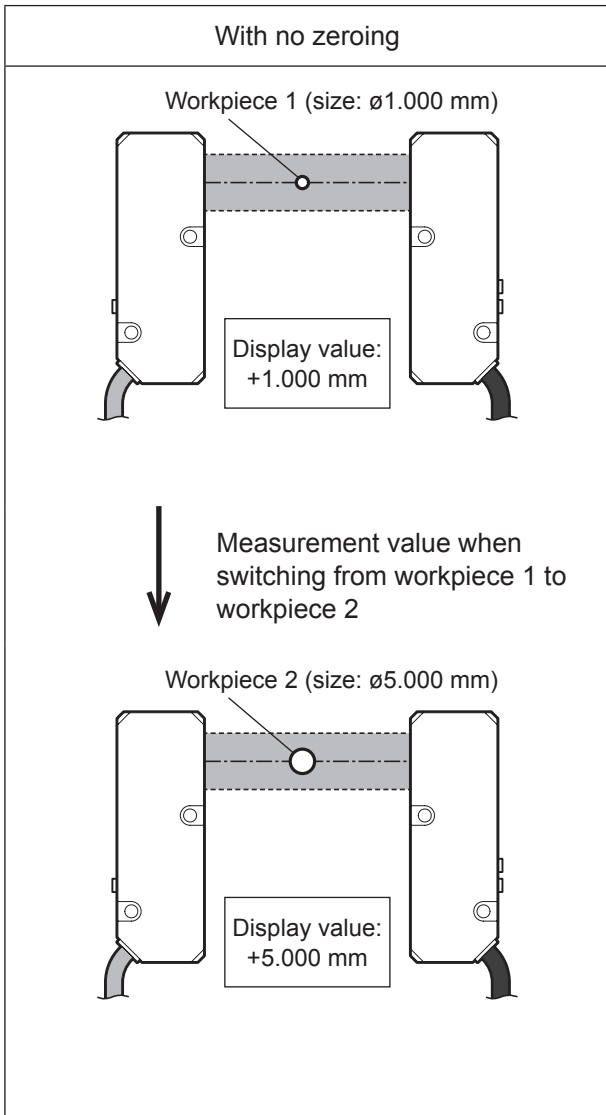

9.2 Zeroing

This section explains how performing zeroing.

Zeroing: Sets the measurement center position to any position.

Useful for checking the displacement amount from the reference position.

■ Performing Zeroing

For a complete list of the setting menu options, see “11 Setting Menu Overview” (page 30).

- 1 Select the channel for which the settings will be changed.**
Press the up or down button to select a channel, and then press the A button.
- 2 Select “Teach mode.”**
Press the down button.
- 3 Select “Zeroing.”**
Use the left or right button to select “Zeroing.”
- 4 Execute Zeroing.**
Place the measurement target in the desired reference position, and press the A button with “Zeroing” displayed.

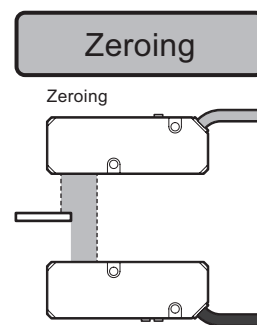
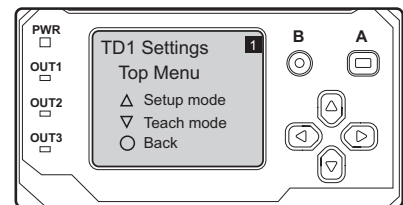
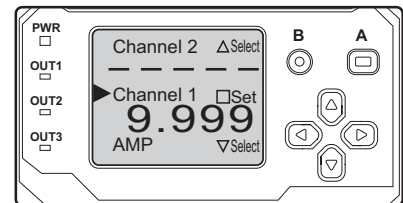

9.3 Checking/Resetting Zeroing Value

■ Checking or Changing a Zeroing Value

For a complete list of the setting menu options, see “11 Setting Menu Overview” (page 30).

- 1 Select the channel for which the settings will be changed.**
Press the up or down button to select a channel, and then press the A button.
- 2 Select “Setup mode.”**
Press the up button.
- 3 Use the left or right button to select “Zeroing value.”**
- 4 Select “Zeroing value.”**
The currently set zeroing value will be displayed. Press the A button to change the zeroing value.
Up/down button: Change value
Left/right button: Select digit
A button: Set
* For information on changing the values, refer to the memo on page 38.
 - The default Zeroing value is 0.

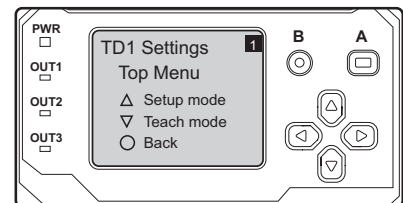
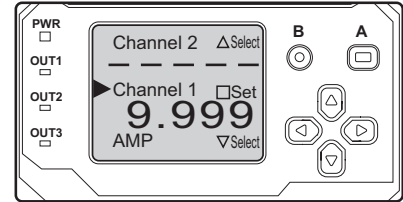

Zeroing value

Measure Type	"Edge"
	-5.000 to +5.000
Measure Type	"Width"
	0.000 to +9.999

■ Resetting the Zeroing Value

For a complete list of the setting menu options, see “11 Setting Menu Overview” (page 30).

- 1 Select the channel for which the settings will be changed.**
Press the up or down button to select a channel, and then press the A button.
- 2 Select “Teach mode.”**
Press the down button.
- 3 Use the left or right button to select “Reset Zeroing.”**
- 4 Execute Resetting.**
Press the A button with “Reset Zeroing” displayed.

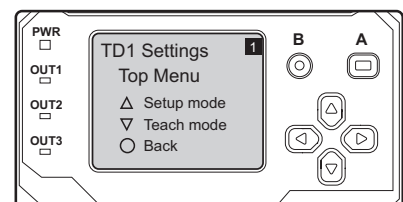
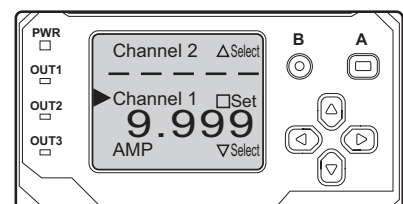

Reset Zeroing

10 Setting Channel 2 to Not Be Used

When Channel 2 will not be used, the settings can be configured to prevent reception of the Channel 2 signal. Configuring this setting will cancel signal communication errors for Channel 2. Canceling such errors will change the PWR indicator from orange to yellow-green.

10.1 Checking the PWR Indicator

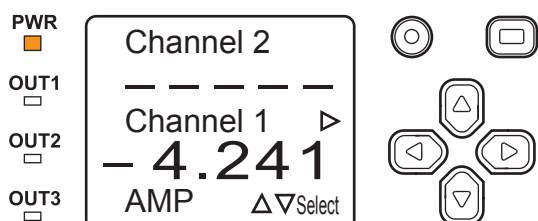

If the PWR indicator is lit in orange, there is a signal communication error with Channel 2. Review the setting procedure in 10.2 below, and configure the settings so that the Channel 2 signal is not received.

10.2 Setting Channel 2 to Not Be Used

From the top screen, press the down button with ► displayed next to “AMP”, and then press the A button.
→ Press the right button to select “Channel Settings”, and then press the up button to display “Channel 2”.
→ Press the up or down button several times to display “No Head”, and then press the A button to enter.

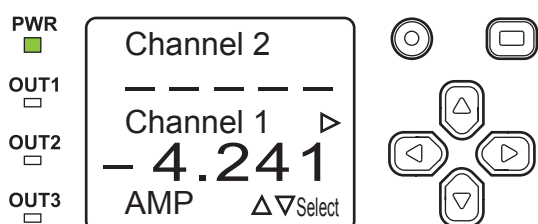

Configuration of the settings is complete if the PWR indicator turns yellow-green.

* Reset the settings when using Channel 2.

11 Setting Menu Overview

● Amplifier unit channel selection menu

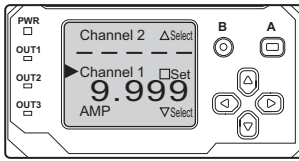

[To the TD1 series menu]
Select the channel for which the settings will be changed.

[To the amplifier unit menu]
Select "AMP."

• For details on how to change the amplifier unit settings, see the CDA series manual.

△ button: Select / □ button: Set

● TD1 series Top Menu

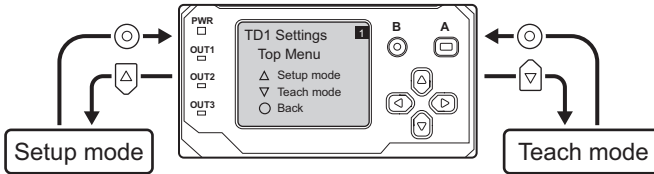

● Setup mode menu

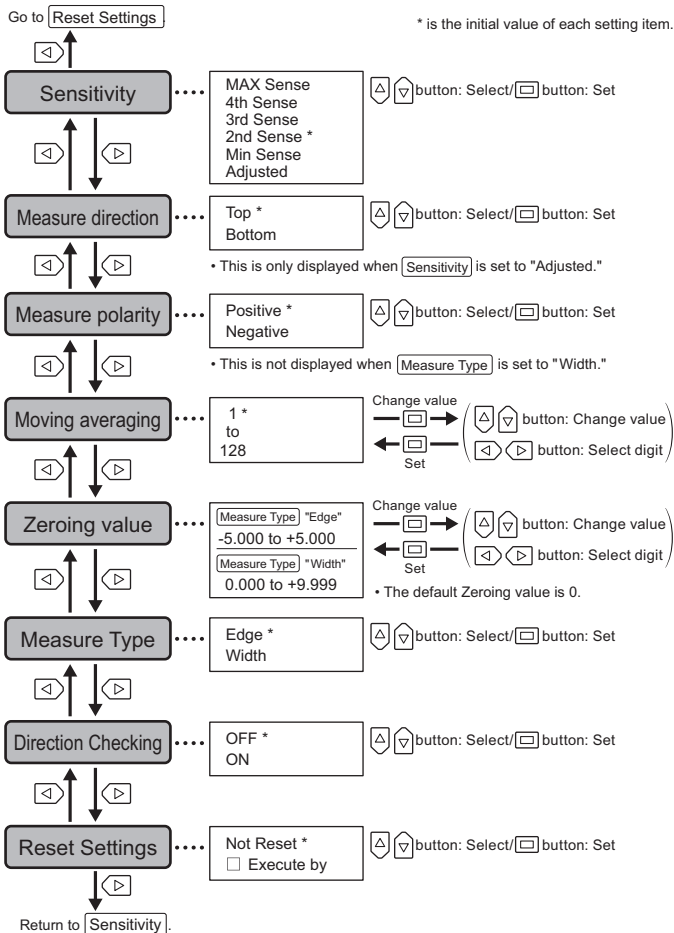

● Teaching menu

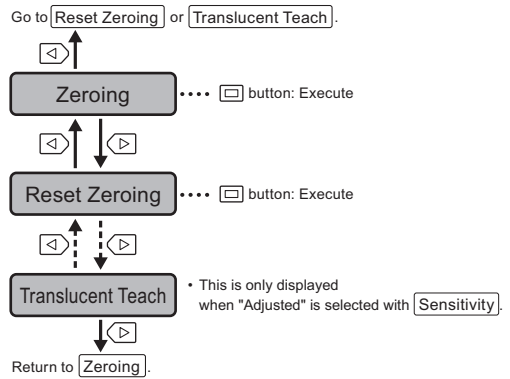

● Amplifier unit channel selection menu

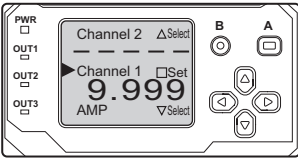

[To the TD1 series menu]
Select the channel for which the settings will be changed.

[To the amplifier unit menu]
Select "AMP."

• For details on how to change the amplifier unit settings, see the CDA series manual.

button: Select/ button: Set

● Amplifier unit Top Menu

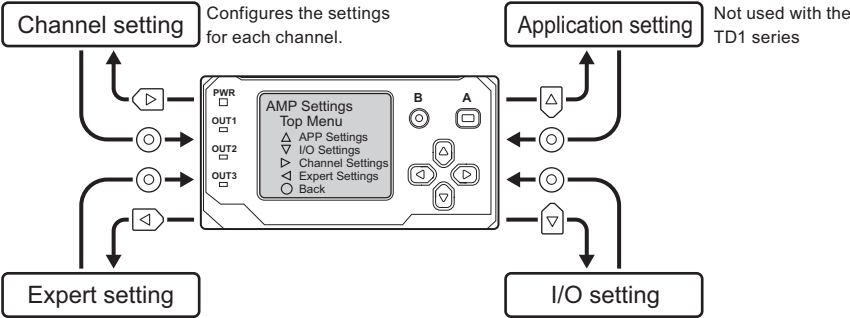

● Expert Setting Menu

* is the initial value of each setting item.

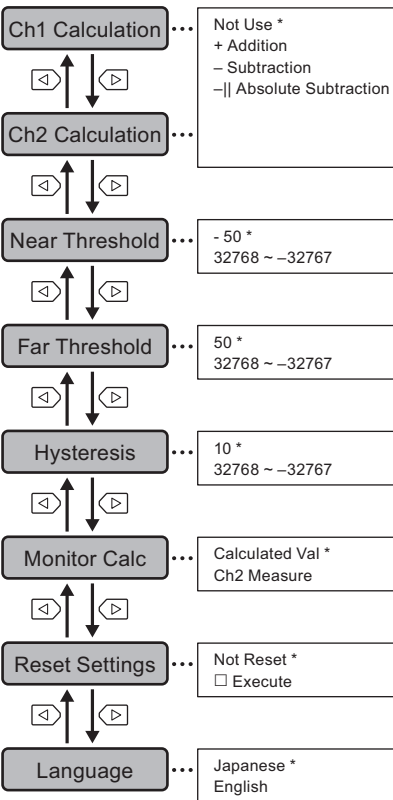

● I/O Setting Menu

* is the initial value of each setting item.

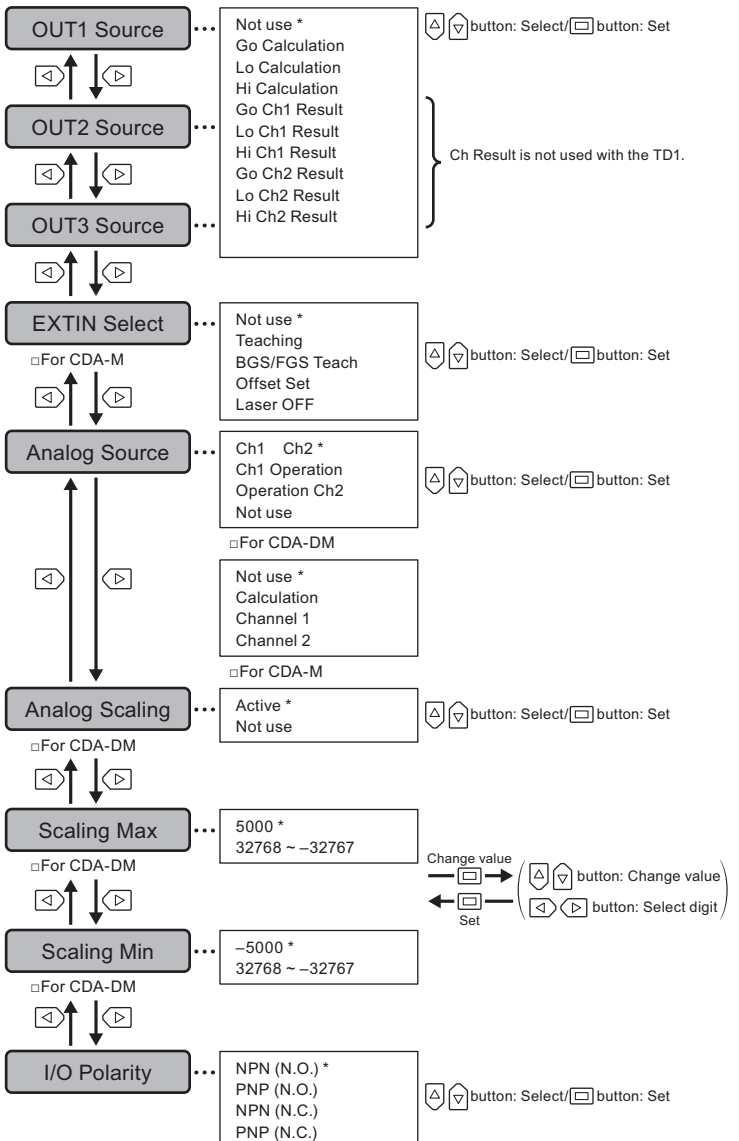

12 CDA Series (Amplifier) Output Settings

12.1 No. and Types of Control Outputs

The CDA series is equipped with three control outputs per unit. The CDA series' three calculation functions for judgment (Hi, Go, and Lo) can be allocated as desired for any control output. However, since there is only one circuit for the calculation function, judgment using the calculation function can be used for only one of the channels.

■ Control Output Setup Flow

- 1** Set the far threshold and near threshold.
- 2** Set the assignments for each control output.

■ Judgment Types

- Hi: Output when measurement is at or above the far threshold
- Go: Output when measurement is between Hi and Lo
- Lo: Output when measurement is at or below the near threshold

■ Threshold Types

- Far Threshold: Values from 0 and toward the + side
- Near Threshold: Values from 0 and toward the – side
- * Make sure to set a near threshold that is less than the far threshold.

■ Assigning Far Threshold and Near Threshold (Upper/Lower Limit)

The following is an example for measurement with “Measure polarity” set to “Positive,” the far threshold sent to +2.500 mm, and the near threshold set to -2.500 mm.

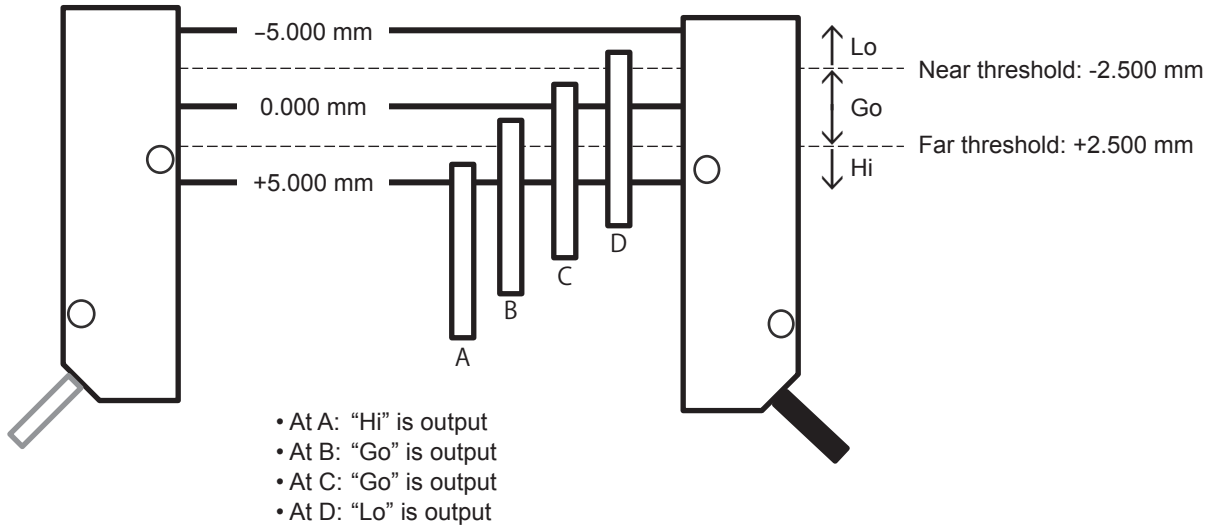

■ Assigning Control Outputs 1 to 3

For actual output operation, control outputs 1 to 3 must be assigned.

The following is an example based on Control Output 1 set to “Hi,” Control Output 2 set to “Go,” and Control Output 3 set to “Lo.”

- [With A] Control Output 1: ON, Control Output 2: OFF, Control Output 3: OFF
- [With B] Control Output 1: OFF, Control Output 2: ON, Control Output 3: OFF
- [With C] Control Output 1: OFF, Control Output 2: ON, Control Output 3: OFF
- [With D] Control Output 1: OFF, Control Output 2: OFF, Control Output 3: ON

12.1.1 Control Output Setup Procedure

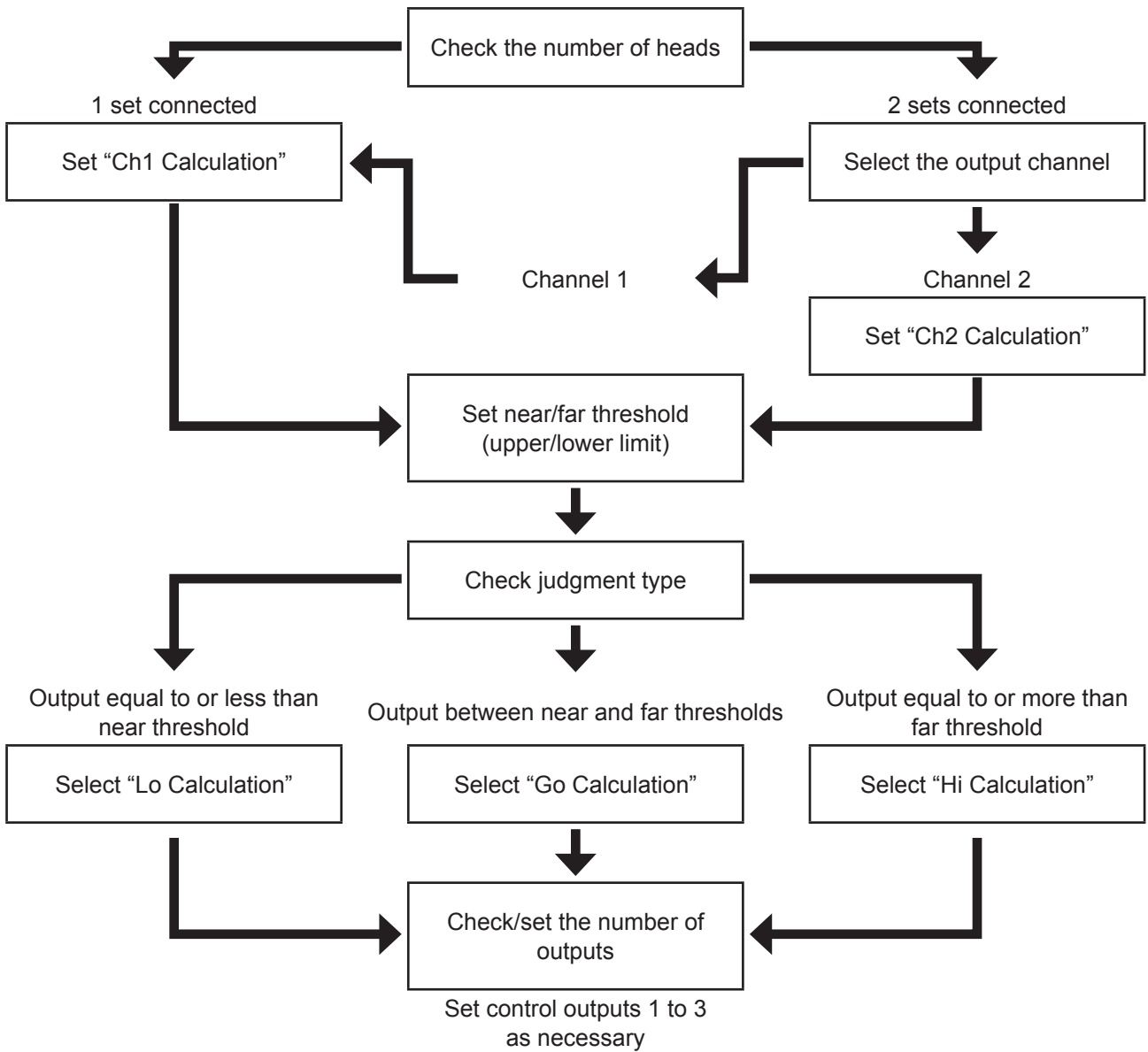

12.1.2 Control (Upper/Lower) Output Settings

This section explains how to set control outputs. As an example, control outputs 1 to 3 are assigned for measurement values from Channel 1.

For a complete list of the setting menu options, see “11 Setting Menu Overview” (page 30).

For details on setting conditions, see “Setting Examples” on page 38.

1 Press the down button.

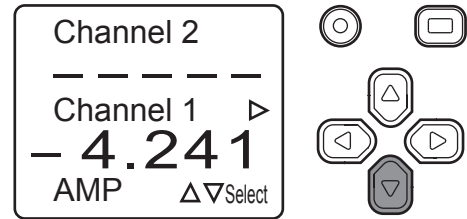

2 Press the A button with ▶ displayed next to “AMP.”

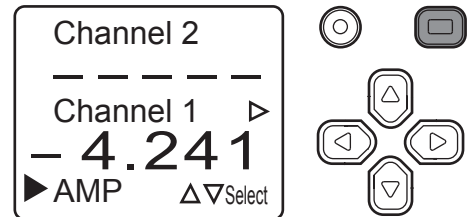

3 Press the left button.

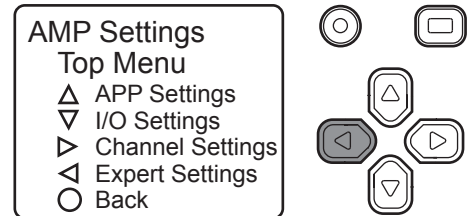

4 Press the up button.

* If “Ch1 Calculation” is not displayed, press the left or right button several times.

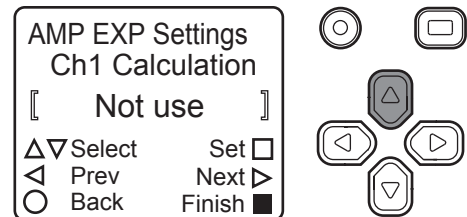

5 Press the A button with “+ Addition” displayed.

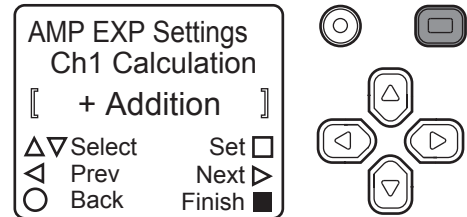

6 Press the right button twice.

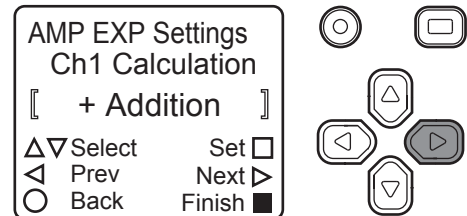

● **Setting the near threshold**

- 7** Press the **A** button to change the value to **-1500**.
 * To change the value: Press the left or right button to change the number of digits. Press the up or down button to change the value.
 * For details, refer to the memo on page 38.

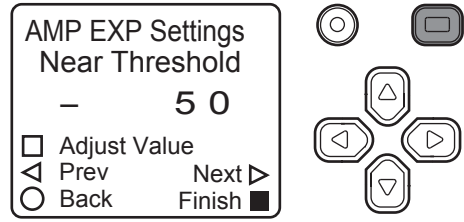

- 8** Press the **A** button with “**-1500**” displayed.

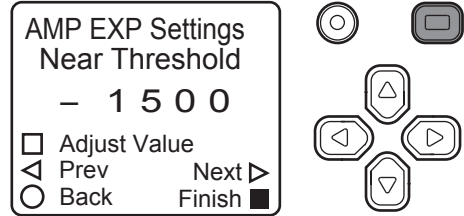

- 9** Press the right button.

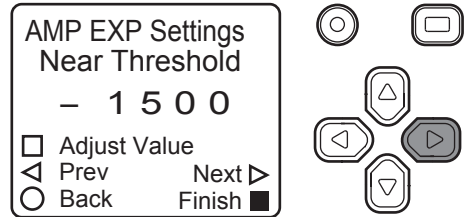

● **Setting the far threshold**

- 10** Press the **A** button to change the value to **-1500**.
 * To change the value: Press the left or right button to change the number of digits. Press the up or down button to change the value.
 * For details, refer to the memo on page 38.

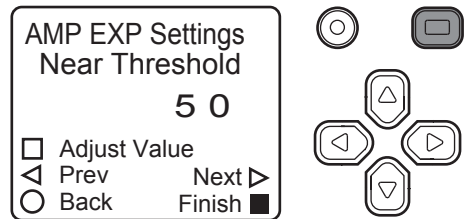

- 11** Press the **A** button with “**1500**” displayed.

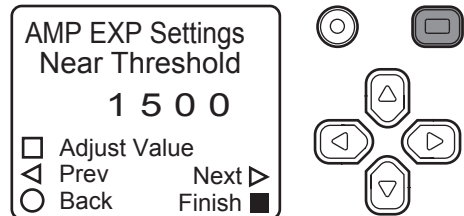

- 12** Press the **B** button.

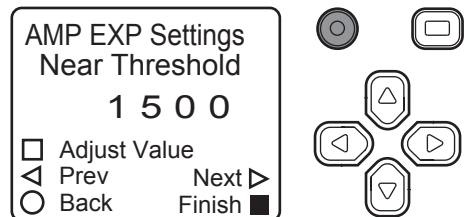

● **Setting the assignments for each control output**

Setting Control Output 1

13 Press the down button.

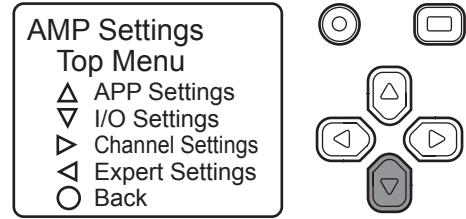

14 Press the up button with “OUT1 Source” displayed.
 * If “OUT1 Source” is not displayed, press the left or right button several times.

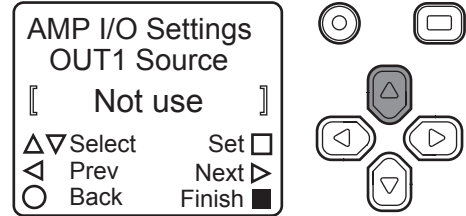

15 Press the A button with “Hi Calculation” displayed.

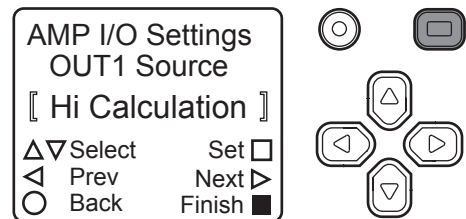

16 Press the right button.

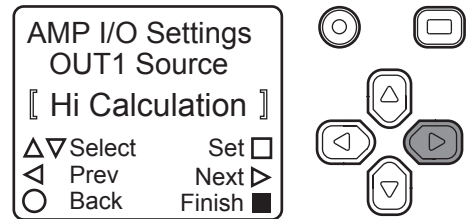

Setting Control Output 2

17 Press the A button with “Go Calculation” displayed.

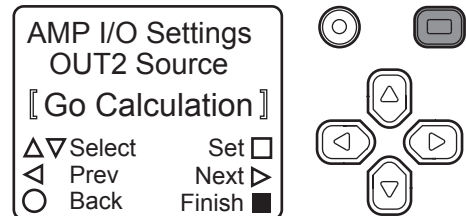

18 Press the right button.

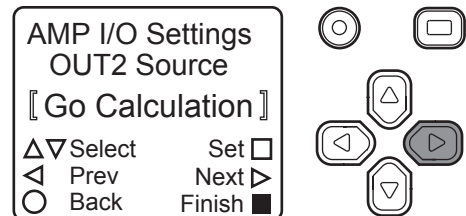

Setting Control Output 3

19 Press the A button with “Lo Calculation” displayed.

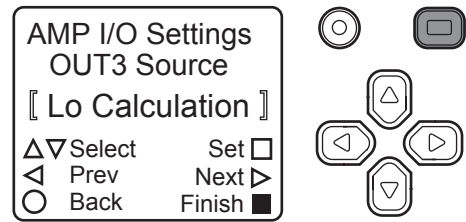

20 Press and hold the B button.

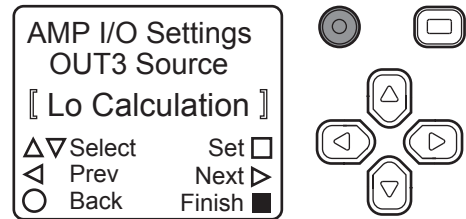

21 The display returns to the top screen (measurement value display screen), signifying that the settings have been configured.

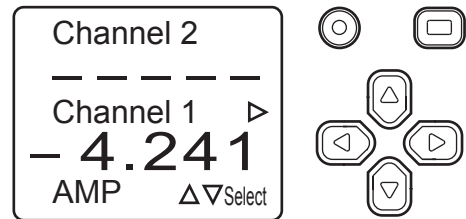

● Setting example

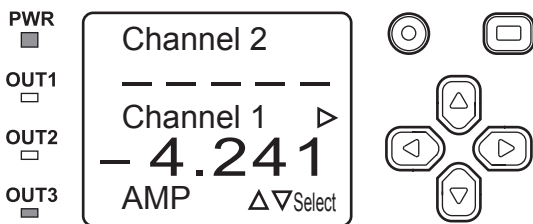

At +1.500 mm or more, Control Output 1 (OUT1) is ON. At ±1.500 mm or more, Control Output 2 (OUT2) is ON. At -1.500 mm or less, Control Output 3 (OUT3) is ON. When an output is ON, the indicator is illuminated. The figure to the left shows Channel 1 as 1.500 mm or less, so Control Output 3 (OUT3) turns ON.

●●● MEMO ●●●

• As shown in the following operation example, it may be possible to move the frame to a digit that is not displayed.

Example: Setting “Clamp holding time” to a four-digit numeric value

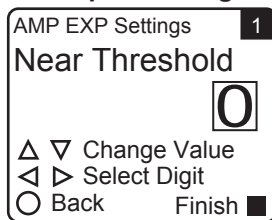

As shown in the above figure, this item's default value is “0.”

Up button: Increases the numeric value.

Down button: Decreases the numeric value.

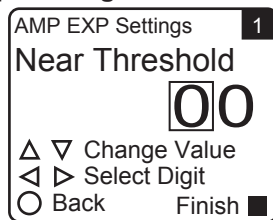

Press the left button once to move to the digit on the left and display a “0.”

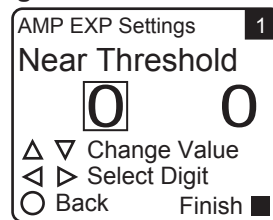

Press the left button twice more to move to the thousands position. The digits between the ones position and the thousands position are not displayed.

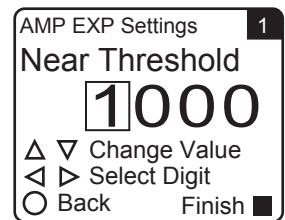

Pressing the up button to change the thousands position value to something other than “0” will cause the intervening digits to be displayed as “0.”

Press the down button with “0000” displayed to show “-”.

• Pressing the B button before pressing the A button to confirm the value change will cancel the change and return to the setting screen.

12.2 Analog Output Settings

This section explains how to set analog output.

■ Configuring Analog Output Settings

For a complete list of the setting menu options, see “11 Setting Menu Overview” (page 30).

1

Select “AMP.”

Press the down button to select “AMP,” and then press the A button.

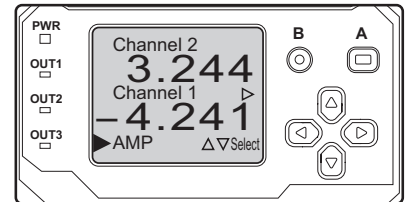

2

Select “I/O Settings.”

Press the down button.

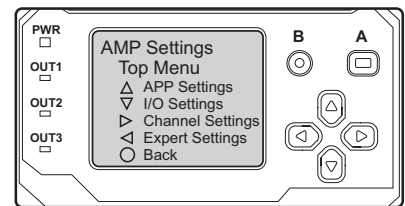

3

Use the left or right button to select “Analog Source.”

- An “EXTIN Select” setting is available when using a CDA-M, but configuration of this setting is not necessary.

4

Select the output target.

■ For CDA-DM

- With “Ch1 Ch2” selected: The measurement values for each channel will be assigned to analog output.
- With “Ch1 Operation” selected: The value from Channel 1 will be used for Output 1, and the calculation value will be used for Output 2.
- With “Operation Ch2” selected: The calculation value will be used for Output 1, and the value from Channel 2 will be used for Output 2.

Analog Source

Ch1 Ch2 *
Ch1 Operation
Operation Ch2
Not use

* is the initial value of each setting item.

■ For CDA-M

- With “Channel 2” selected: The measurement value for Channel 2 will be assigned to analog output.
- With “Channel 1” selected: The measurement value for Channel 1 will be assigned to analog output.
- With “Calculation” selected: The calculation will be assigned to Analog Output 1.

Analog Source

Not use *
Calculation
Channel 1
Channel 2

* is the initial value of each setting item.

Press the A button with the selected output target displayed.

12.2.1 Analog Scaling Settings

The CDA series makes it possible to convert analog current or voltage output to actual sensor measurement values. Changing the analog scaling setting makes it possible to set any analog current or voltage output.

■ Configuring Analog Scaling Settings

For a complete list of the setting menu options, see “11 Setting Menu Overview” (page 30).

1 Verify that any setting other than “Not use” is selected for “Analog Source.”

For information on configuring the settings, refer to page 39.

2 Select “Amplifier.”

Press the down button to select “AMP,” and then press the A button.

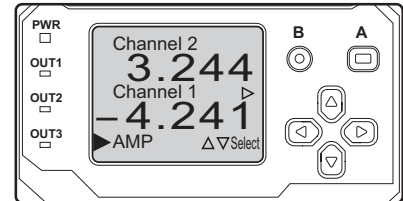

3 Select “I/O Settings.”

Press the down button.

4 Use the left or right button to select “Analog Scaling.”

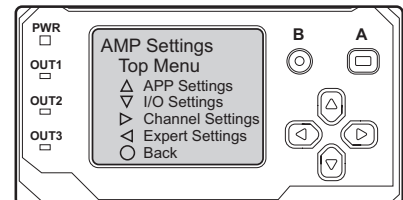

5 Change “Analog Scaling” to “Active.”

Press the up button to select “Active,” and then press the A button.

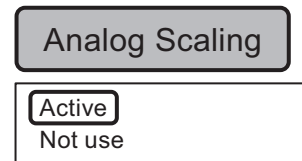

● **Analog scaling maximum setting**

6 Use the left or right button to select “Scaling Max.”

Press the A button to change the maximum analog scaling value.

* For information on changing the values, refer to the memo on page 38.

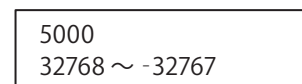

● **Analog scaling minimum setting**

7 Use the left or right button to select “Scaling Min.”

Press the A button to change the minimum analog scaling value.

* For information on changing the values, refer to the memo on page 38.

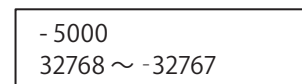

12.2.2 Analog Output Specifications

Analog output and scaling when using a TD1 series product and a CDA series product are as follows. Note that the output type varies depending on the model.

CDA-M: Analog current output of 4 to 20 mA

CDA-DM: Analog voltage output of 0 to 10 V, for 2 heads (2 outputs)

Scaling can be set as desired between +32767 and -32768.

Analog output when using the CDA-DM to set “Scaling Max” to 5000 and “Scaling Min” to -5000:

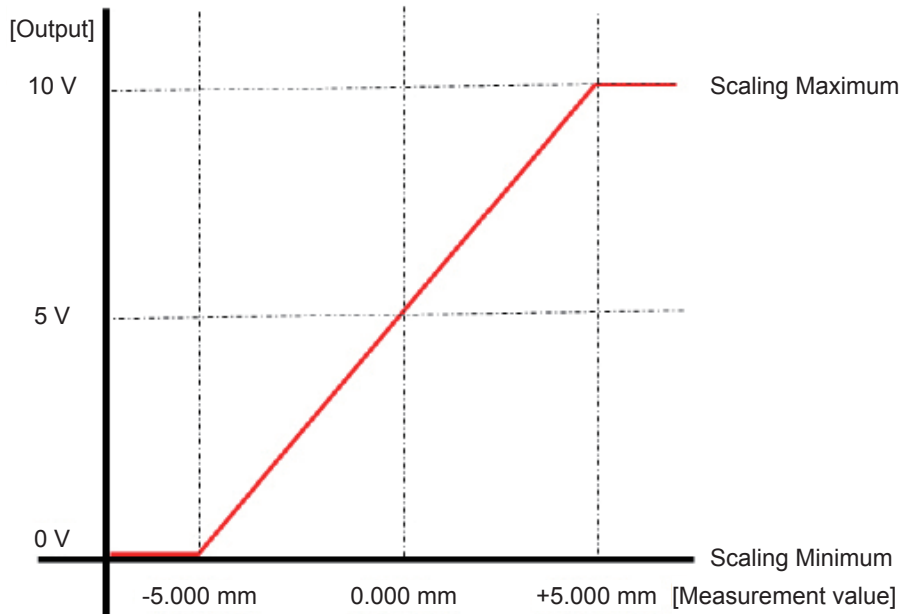

- There are two situations in which measurement is not possible with the TD1 series. During complete light detection or with a measurement error, output becomes 10 V or 20 mA, and with no light detection, output becomes 0 V or 4 mA.

Complete light detection

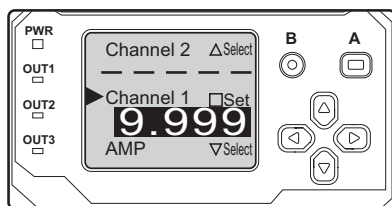

No light detection (complete interruption)

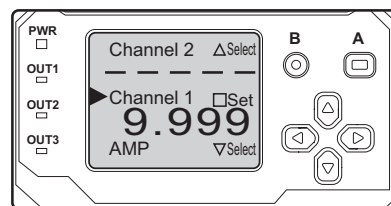

13 CDA Series Calculation

When measuring the width of sheet material or cylindrical object with a diameter of 10 mm or more using two sets of TD1 series products and the calculation function of a CDA series product, measurement of the increase or decrease in diameter and width is possible. The difference from the master workpiece is displayed. (However, the measurement range of 10 mm for all TD1 series products does not change.)

When measuring a master workpiece

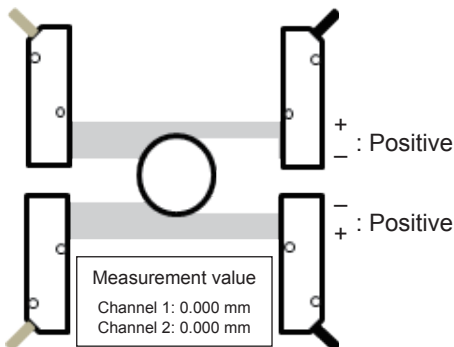

When measuring an item smaller than the master workpiece

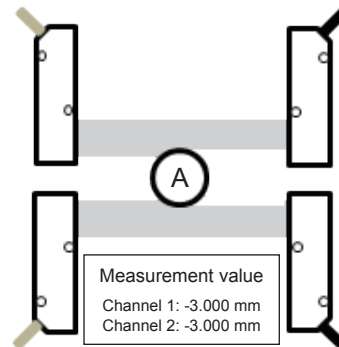

When measuring an item larger than the master workpiece

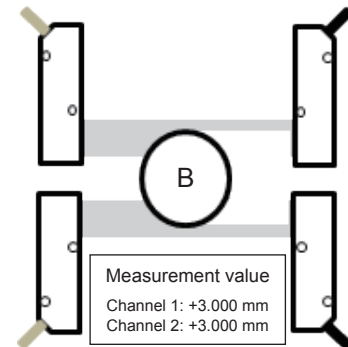

- The increase or decrease in width from the zeroed measurement value is output.
With Workpiece A, -6.000 mm will be output as the total of the Channel 1 and 2 measurement values.

13.1 Mounting and Measurement Polarity

There are three mounting methods when using two sets of TD1 series products for width or diameter measurement. Set "Measure polarity" according to the mounting method.

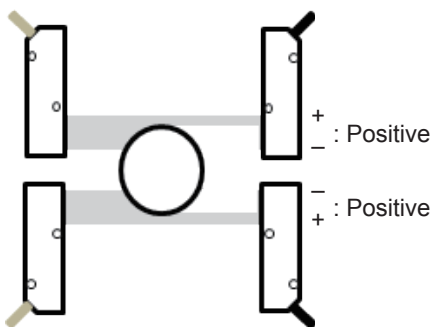

With two devices both with "Measure polarity" set to "Positive"

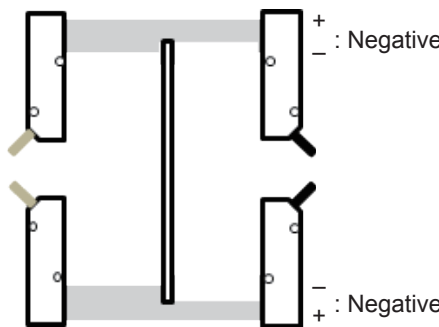

With two devices both with "Measure polarity" set to "Negative"
* "Positive" mode is selected by default.

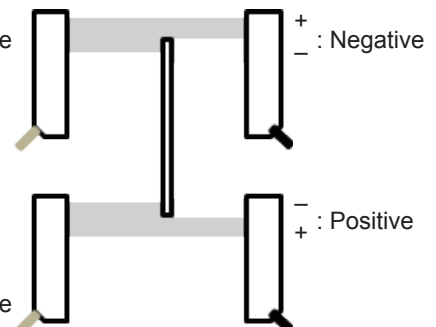

With the upper sensors set to "Negative" and the bottom sensors set to "Positive"

13.2 Calculation Settings

What is the calculation function? — When measuring the width of sheet material or cylindrical object with a diameter of 10 mm or more using two sets of TD1 series products and the calculation function of a CDA series product, measurement of the increase or decrease in diameter and width is possible. The difference from the master workpiece is displayed. (However, the measurement range of 10 mm for all TD1 series products does not change.)

The items that must be set for calculation are as follows.

- Measurement Polarity Setting
- Channel Calculation Setting
- Analog Output Settings
- Zeroing

■ Measurement Polarity Setting (When setting “Measure polarity” to “Negative”)

For a complete list of the setting menu options, see “11 Setting Menu Overview” (page 30).

- 1** Press the up button.
Press the up or down button to select Channel 1.
- 2** Press the A button.
- 3** Press the up button.
- 4** Use the left or right button to select “Measure polarity.”

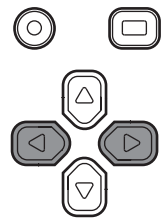
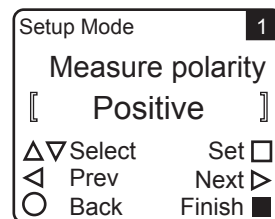
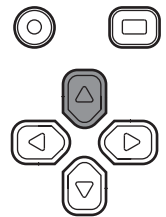
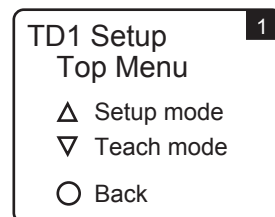
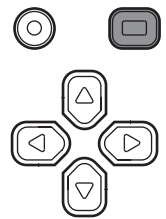
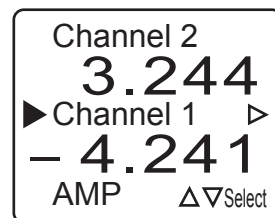
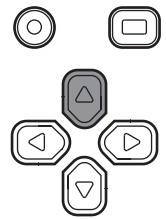
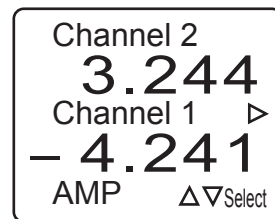

5 Use the up button to select “Negative.”

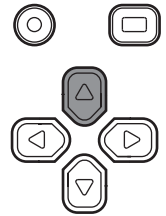
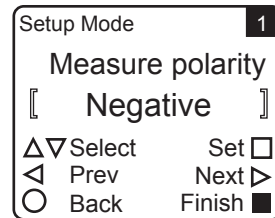

6 Press the A button with “Negative” displayed.

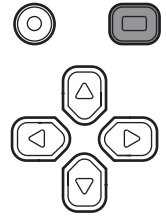
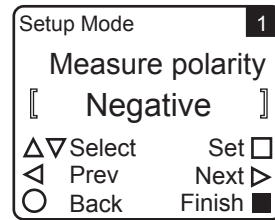

■ Channel Calculation Setting

Setting Channel 1 and 2 calculation to “+ Addition” will result in calculation showing the amount of change in width. The output value is the increase or decrease in width from the zeroed measurement value. For details, see page 42.

For a complete list of the setting menu options, see “11 Setting Menu Overview” (page 30).

1 Press the down button.

* If zeroing has been performed, “0.000” will be displayed for both Channel 1 and Channel 2.

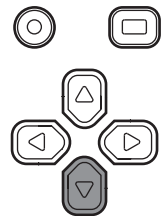
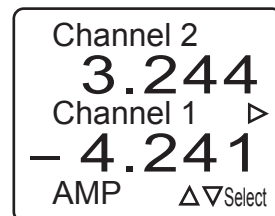

2 Press the A button with “AMP” selected.

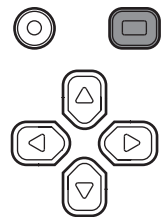
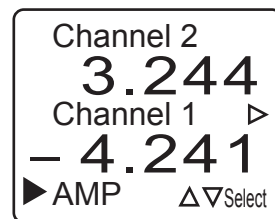

3 Press the left button.

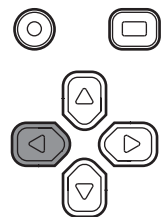
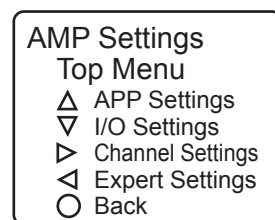

4 Press the A button with “+ Addition” selected.
Press the right button to select “Ch2 Calculation.”

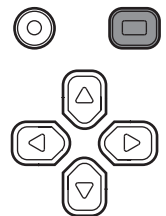
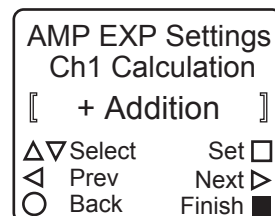

5 Press the A button with “+ Addition” selected.

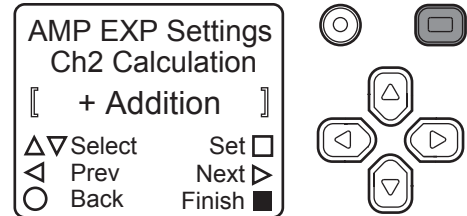

6 Press the B button twice.

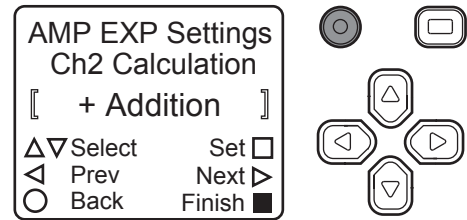

7 Press the right button.

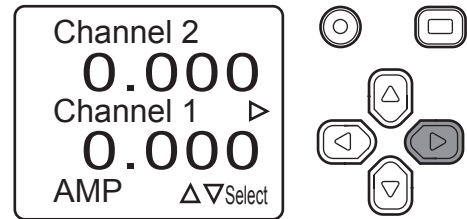

8 Check the calculated value.

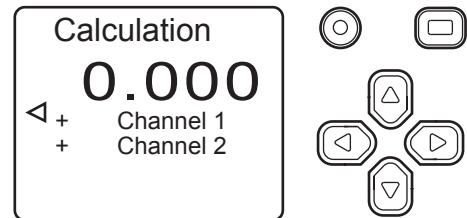

■ Analog Output Settings

For details, see page 39.

■ Zeroing

Zeroing will be performed for both sensor pairs with the master workpiece set. The setting for Channel 1 will be changed.

For a complete list of the setting menu options, see “11 Setting Menu Overview” (page 30).

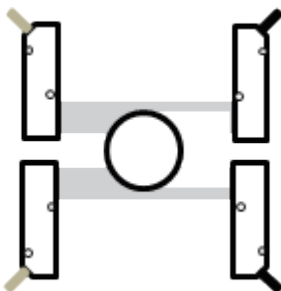

Configure the settings with the workpiece to be used as the reference measurement target (master workpiece) already set.

1 Press the up button.
Press the up or down button to select Channel 1.

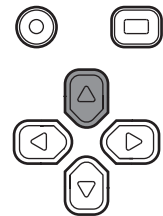
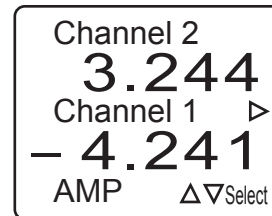

2 Press the A button.

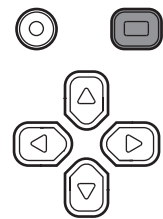
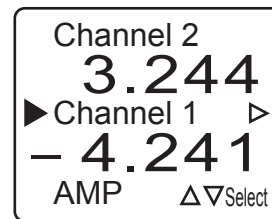

3 Press the down button.
Select "Teach mode."

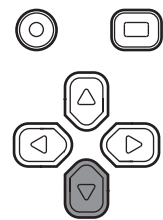
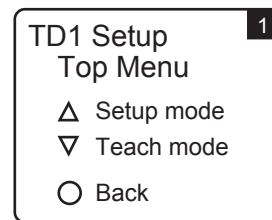

4 Execute Zeroing.
Place the measurement target in the desired reference position, and press the A button with "Zeroing" displayed.
* If "Zeroing" is not displayed, press the left or right button several times.

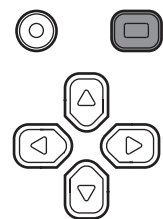
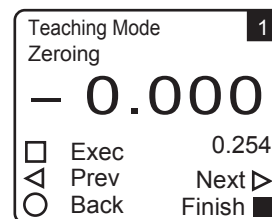

5 Press the B button twice.
The zeroing value is displayed.

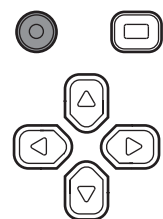
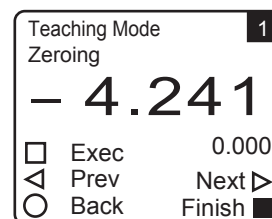

6 Configuration is complete if the Channel 1 display value is "0.000." Follow the same procedure to configure Channel 2.
* The display is not guaranteed to be 0.000.

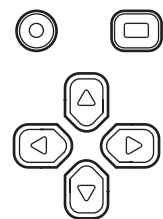

■ Zeroing from External Input (Only for CDA-M)

Zeroing can be performed through external input when using the CDA-M. This is useful, for example, when measuring a large variety of products or when changing the size of the master workpiece. The ability to perform zeroing using only external inputs means it is possible to skip “Zeroing.”

Ex. 1: Frequent changes of the master workpiece size

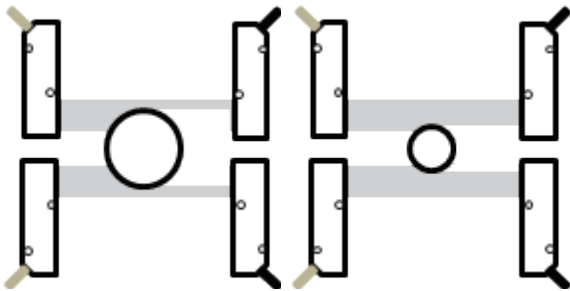

Ex. 2: Measurement of various product types

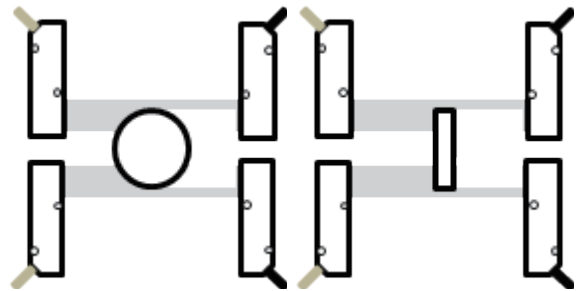

■ Configuring Zeroing from External Input

For a complete list of the setting menu options, see “11 Setting Menu Overview” (page 30).

1 Press the down button.

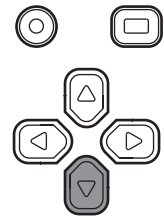
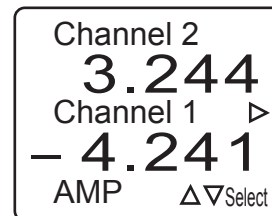

2 Press the A button with “AMP” selected.

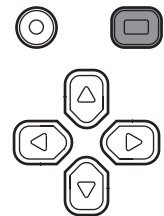
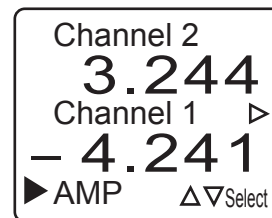

3 Press the down button.

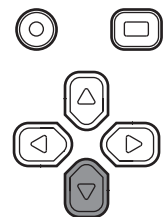
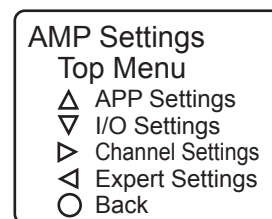

4 Use the left or right button to select “EXTIN Select.”

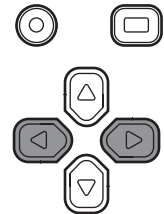
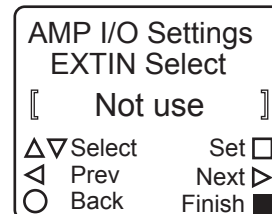

5 Use the up or down button to select “Teaching.”

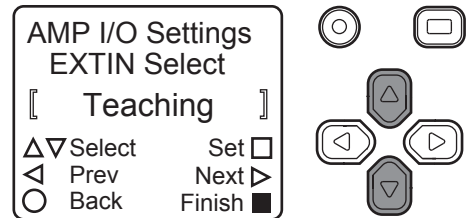

6 Press the A button with “Teaching” selected.

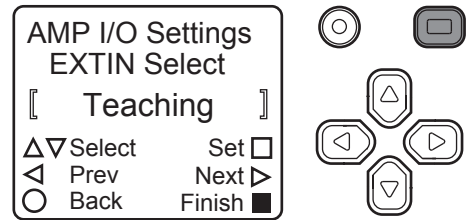

This setting saves time and effort spent on navigating from the Settings screen to “Zeroing” each time the master workpiece is changed.

Configuring these settings makes it possible to simply replace the master workpiece and perform zeroing from a signal inputted externally.



INSTRUCTION MANUAL

Through-beam Edge Sensor

TD1 Series

TD1-010M8

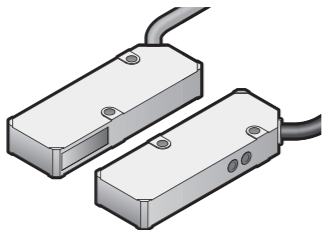

OPTEX FA CO.,LTD.

- Thank you for purchasing this Through-beam Edge Sensor TD1 series.
- Before using this product, please read this manual carefully to ensure proper use.
- Read this manual thoroughly, and then keep this manual at hand so that it can be used whenever necessary.
- The warranty period of this product is one year after delivery. However, any fault attributable to natural disasters or any other similar disasters or modification or repair will be excluded from the scope of the warranty.
- When exporting a device in which this product is embedded to an EU nation*, the EU Battery Directive applies even to embedded devices, so we ask that you provide the following support.
 - When exporting a product to an EU nation*, include the latest instruction manual of this product. If it is not possible to include the instruction manual of this product, write the section <Symbol mark explanation> in the device's manual.
- *: The term EU nation includes Switzerland, Ireland, Norway, Liechtenstein, and Turkey in addition to the member nations of EU.

Safety Precautions

Safety precautions for ensuring safe operation of this product are displayed as follows with the following symbols.

Precautions listed here describe important information about safety. Make sure to follow them accordingly.

Safety Symbols

	WARNING	Indicates that any improper operation or handling may result in moderate or minor injury, and in rare cases, serious injury or death. Also indicates a risk of serious property damage.
	CAUTION	Indicates that any improper operation or handling may result in minor injury or property damage.

WARNING	
	This product cannot be used as protective equipment for the purpose of protecting the human body.
	Do not disassemble, repair, modify, deform under pressure, or attempt to incinerate this product. Doing so may cause injury or fire.
	Do not use this product in water or in a location where it may be exposed to water. Do not use this product if wet. Doing so may cause a fire or damage the product.
	This product is not explosion-proof and should not be used around flammable or explosive gases or liquids. Doing so may cause ignition resulting in an explosion or fire.
	Do not use air dusters or any spray that uses flammable gas around the product or on the inside of the product. Doing so may cause ignition resulting in an explosion or fire.
	Do not install this product in any of the following locations. Doing so may cause a fire, damage, or a malfunction. <ol style="list-style-type: none"> 1. Locations where dust, salt, iron powders, or vapor (steam) is present. 2. Locations subjected to corrosive gases or flammable gases. 3. Locations where oil or chemical splashes may occur. 4. Locations where heavy vibrations or impacts may occur. 5. Locations where the ambient temperature exceeds the rated range. 6. Locations subject to rapid temperature changes (or where condensation occurs). 7. Locations with strong electric or magnetic fields. 8. Outdoor locations or locations subject to direct light.
	Do not use the product at voltages or with AC power supplies that exceed the rated voltage. Doing so may cause a fire or damage the product.
	Do not use this product in a non-industrial setting. Doing so may cause induction or radiation interference.
	This product is not intended for use with nuclear power, railways, aviation, vehicles, medical equipment, food-handling equipment, or any application where particular safety measures are required. Absolutely do not use this product for any of these fields.
	This product cannot be used in applications that directly or indirectly detect human bodies for the purpose of ensuring safety. Do not use this product as a detection device for protecting the human body.
	What to do in the event of a malfunction such as smoke being emitted from the product If you detect any malfunction including emission of smoke, abnormal smells or sounds, or the body becoming very hot, immediately stop operating the product and turn off the sensor power. Failure to do so may cause a fire. Repairing the product is dangerous and should in no way be performed by the customer. Contact an OPTEX FA sales representative for repairs.
	What to do if water enters the product If water or any other liquid enters the product or the cable, immediately stop operating the product and turn off the power. Using the product in this condition may cause a fire.

CAUTION

- Make sure to turn the power off before wiring the cable or connecting/disconnecting the connector. Connecting or disconnecting while energized may damage the product or cause electric shock.
- Avoid wiring in parallel with or in the same piping as high-voltage wires or power lines. Doing so may cause malfunction or damage by induction.
- Do not bend the cable when below the freezing point. This may cause the cable to break.
- Do not drop the product or subject the product to strong impacts. Doing so may damage the product.
- Follow the instructions in this manual or the specified instruction manual when wiring the product or the dedicated controller for the correct wiring method. Incorrect wiring can damage the product or the controller, or cause a malfunction.
- When disconnecting the connector, be careful not to touch the terminals inside the connector, and do not allow foreign objects to enter the connector.
- Install this product as far away as possible from high-voltage equipment, power equipment, equipment that generates large switching surges, inverter motors, welders, or any equipment that can be a source of noise.
- When connecting or disconnecting the cable, make sure to hold it by the connector portion, and do not apply excessive force to the cable.
- Do not touch the product or the cable with wet hands. Doing so may damage the product.
- Use the dedicated cable for connecting the product. Use of anything other than the dedicated cable may cause a malfunction or damage the product.
- Tighten the sensor head mounting screws (included screws or the like) with a tightening torque of no more than 0.5N·m. Excessive tightening torque may damage the sensor head.
- Use the product and dedicated controller within the rated ranges.
- Do not excessively twist or apply stress to the cable. Doing so may damage the cable or its connector.
- Install the product and the dedicated controller securely. Failure to ensure secure installation may result in the product falling and becoming damaged.
- During operation, this product becomes very hot. Do not touch it for long time. Doing so may cause a low-temperature burn.
- After changing the settings, wait for at least 3 seconds before turning this product off.

Precautions for Laser Use

- This product emits a Class 1 visible laser beam that is compliant with JIS C6802/IEC 60825-1 laser product safety standards.
- If this product is to be exported to the United States, it is necessary to follow laser standards as stipulated by the American Food and Drug Administration (FDA).
- A report for this product has been submitted to the CDRH (Center for Devices and Radiological Health).
- Do not allow a laser beam to enter an eye, either directly or reflected from a reflective object. Short-term visual disturbances such as flash-blindness and after-images may result from direct-beam viewing.
- If installing this product in your own equipment, ensure that the product is properly handled according to the laws and regulations of the relevant country or region.
- This product does not have a function that stops the emission of light from the laser during disassembly. Do not disassemble the product.
- Do not disassemble or modify this product. Using the product after it has been modified may cause induction and radiation interference.

NOTICE

- After carefully considering the intended use, required specifications, and usage conditions, install and use the product within the specified ranges.
- All specifications may be changed without notice.
- When using this product, it is the responsibility of the customer to ensure necessary safety designs in hardware, software, and systems in order to prevent any threat to life, physical health, and property due to product malfunction or failure.
- Do not use this product for the development of weapons of mass destruction, for military use, or for any other military application. Moreover, if this product is to be exported, comply with all applicable export laws and regulations, including the "Foreign Exchange and Foreign Trade Act" and the "Export Administration Regulations," and carry out the necessary procedures pursuant to the provisions therein.
- Before using this product, fully examine the applicable environmental laws and regulations, and operate the product in conformity to such laws and regulations. OPTEX FA does not assume any responsibility for damages or losses occurring as a result of noncompliance with applicable laws and regulations.

1. Included Accessories/Options

Included Accessories

- Instruction manual (this manual)
- Sensor/amplifier connection cable (Y branch cable)
Model: TDCN-Y2-M8

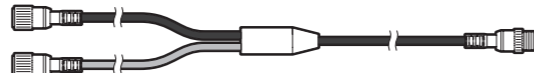

- Cable with M8, 4-pin connector for connecting the sensor and the amplifier unit (Y branch cable)
- Up to two sensor sets can be connected to one amplifier.
- Cable length: 2 m
- This is not included in the package of TD1-010M8J.

Options

- Amplifier Unit
Model: CDA-M/DM

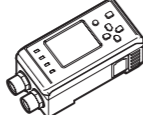

This product is used while connected to the amplifier unit CDA-M/DM. Connecting to a CDA-M/DM makes it possible to use the following functions.

- Displaying the settings and measured values (See "5. Setting Menu Overview" on the back side.)
- Analog and control output (See the CDA series instruction manual.)

- Sensor/amplifier connection cable (straight cable)
Model: DSL-0804-G02M (Cable length: 2 m)
Model: DSL-0804-G05M (Cable length: 5 m)



- Cable with M8, 4-pin connector for connecting the sensor and the amplifier unit (straight cable)
- Two cables are required for one sensor set.
- One sensor set can be connected to one amplifier.
- This can also be used as an extension cable for the TDCN-Y2-M8 (Y branch cable). Ensure that the overall cable length between the TD1 series and the CDA series amplifier unit is within 10 m.

2. Dimensions

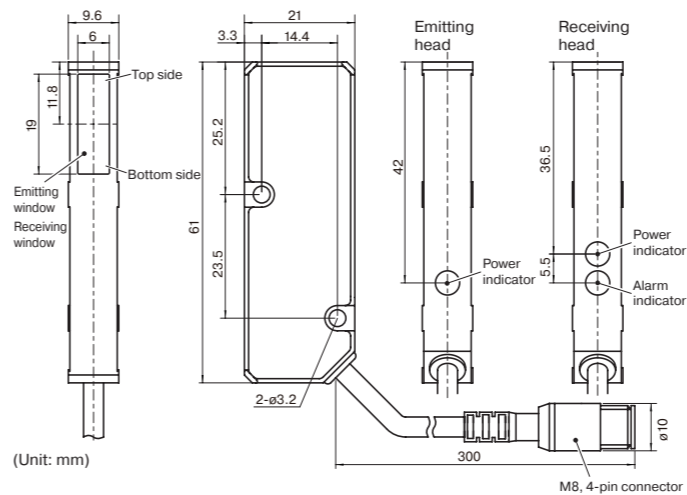

Pin No.	Wire color	Function	
		Emitting head side	Receiving head side
(1)	Brown	12 to 24 VDC ± 10%	
(3)	Blue		0 V
(4)	Black	(N.C.)	RS-485 (A)
(2)	White	(N.C.)	RS-485 (B)

3. Connecting and Mounting

Connecting

With a Y branch cable

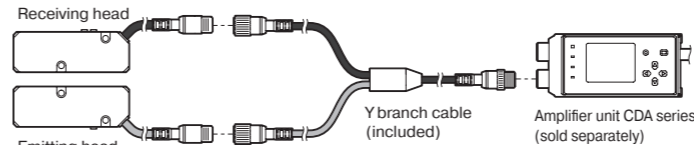

- When using a Y branch cable, connect the cables with the same colors to each other.

With straight cables

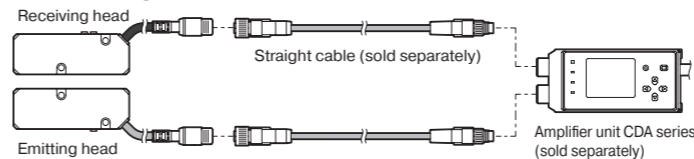

- Using Straight cable, the measured value is displayed on the channel of the side to which the receiving head is connected.
- Perform installation so that the minimum bend radius of each cable is 30 mm or more.

Mounting Method

Use the head reference surfaces as a guide to align the light axis between the emitting and receiving sides when mounting this product.

If it is difficult to align the reference surfaces due to factors such as the conditions of the installation position, check the light axis according to **Direction Checking** on the back side.

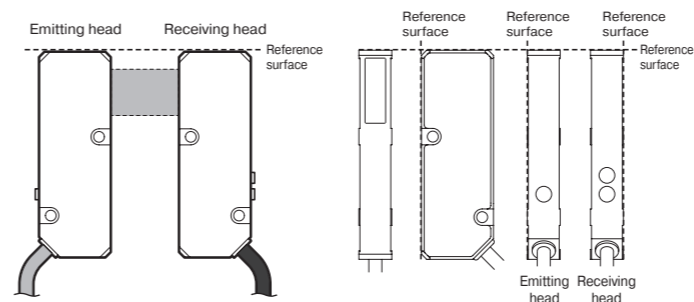

Examples of incorrect mounting

Inverted mounting

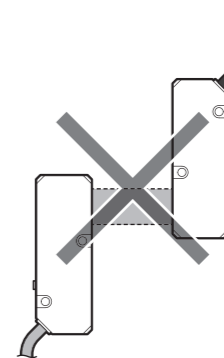

Mounting in a position where light enters the receiving head directly

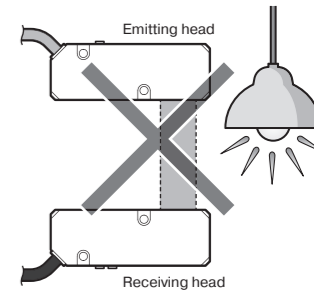

Mounting with the light axis misaligned

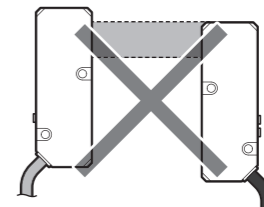

Tilted mounting

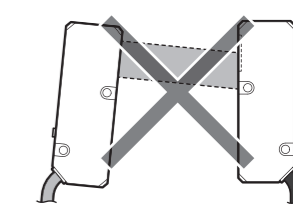

CHECK! See **Direction Checking** on the back side and adjust the light axis so that the mounting positions become correct.

- If you mount this product as shown above, it may not be able to perform accurate measurements.

4. Specifications

Model		TD1-010M8
Measurement range		Edge: ±5 mm, width: 10 mm
Distance between heads		Max. 300 mm
Light source	Medium (Wavelength)	Red semiconductor laser (Wavelength: 660 nm)
	Maximum output	390 µW
Laser class		CLASS 1 (IEC/JIS)/ Class 1 (FDA)*1
Spot size		3 × 14 mm
Linearity		With a distance between heads of 100 mm: ±0.4% of F.S. (±40 µm)
Repeatability*2		±5 µm
Sampling period		500 µs
Temperature drift		±0.02% of F.S./°C
Indicators*3		Emitting head, Power indicator: green Receiving head, Power indicator: green, alarm indicator: red
Serial interface		RS-485
Supply voltage		12 to 24 VDC ±10%
Current consumption		Emitting head: 20 mA or less (at 12 VDC) Receiving head: 80 mA or less (at 12 VDC)
Connection type		Pig tail type: Cable with M8, 4-pin connector, 300 mm length
Protection circuit		Reverse connection protection
Environmental resistance	Degree of protection	IP50
	Ambient temperature/humidity	-10 to +50°C/35 to 85%RH (no freezing or condensation)
	Storage temperature/humidity	-20 to +60°C/35 to 85%RH (no freezing or condensation)
	Ambient illuminance	Sunlight: 10,000 lx or less, incandescent lamp: 3,000 lx or less
	Vibration resistance	10 to 55 Hz; double amplitude 1.5 mm; 2 hours in each of the X, Y, and Z directions
Applicable regulations	Shock resistance	Approx. 50 G (500 m/s ²); 3 times in each of the X, Y, and Z directions
	EMC	EMC directive (2014/30/EU)
Applicable standards	Environment	RoHS directive (2011/65/EU), China RoHS (MIT Order No. 32)
	Weight	Emitting head, receiving head: 30 g each (including 300 mm connector cable)
Material		Housing: aluminum die cast, emitting/receiving part: glass

*1 In accordance with the FDA provisions of Laser Notice No. 50, the laser is classified as Class 1 per the IEC 60825-1:2007 standard.

*2 With an averaging count of one

*3 For the lighting status of the indicators, see **Direction Checking** on the back side.

- Support for the China RoHS directive

10 For details on the support for the China RoHS, see the following website.
https://www.optex-fa.com/rohs_cn/

- Specifications are subject to change without notice
- For more information, questions and comments regarding product, please contact us below.

5. Setting Menu Overview

Amplifier unit channel selection menu

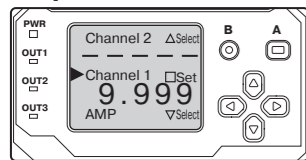

[To the TD1 series menu]
Select the channel for which the settings will be changed.
[To the amplifier unit menu]
Select "AMP."

- For details on how to change the amplifier unit settings, see the CDA series manual.

△ button: Select/ □ button: Set

TD1 Series Top Menu

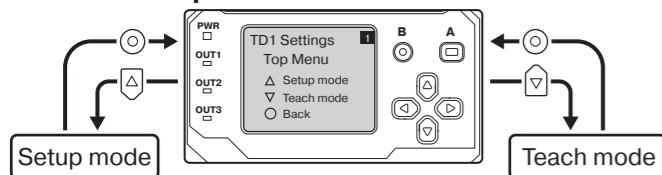

Procedure of Setup mode

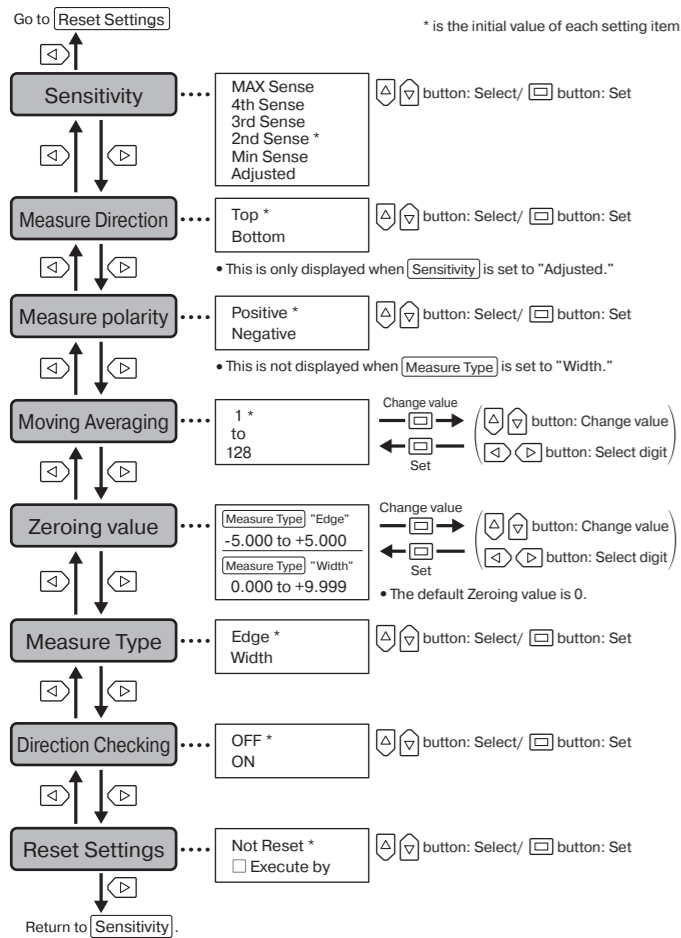

Procedure of Teach mode

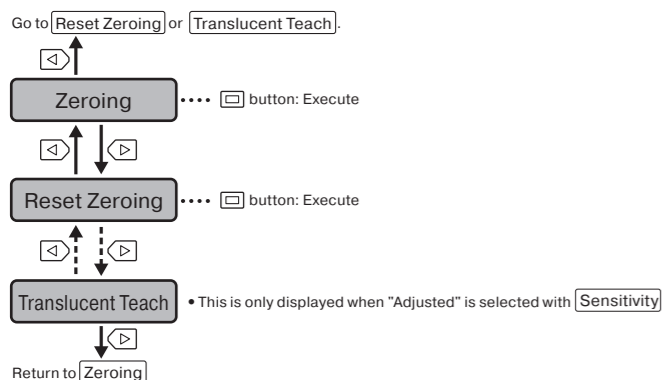

6. Setting Item Details

Details on Setup mode

Measure Type

There are two types: "Edge" (single edge measurement) and "Width" (width or gap measurement).

To measure the edge of the target

Use Measure Type to select "Edge."

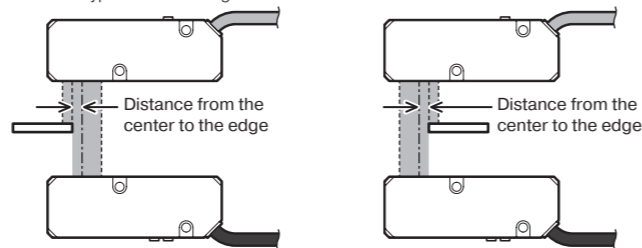

The displacement from the center of the light axis for a single edge is measured. The target insertion direction can be set to either Top or Bottom. Measurement cannot be performed if two or more edges exist within the measurement range.

To measure the target width or the gap between targets

Use Measure Type to select "Width."

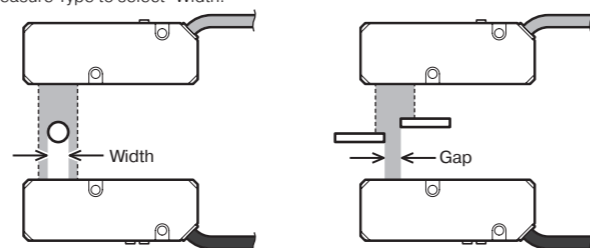

The distance between two edges will be measured. You can measure either the target width or the gap between two targets. Measurement cannot be performed if only one edge exists or three or more edges exist within the measurement range.
* With the CDA series amplifier unit, if the measurement target does not exist, "9999" is displayed (with the character and background colors inverted) with complete light detection and "-9999" is displayed when the light is completely blocked.

Measure polarity

Select whether to set the top side to -5.000 mm and the bottom side to +5.000 mm or vice-versa when measuring edge positions. [Measure polarity] is only enabled during "Edge" measurement.

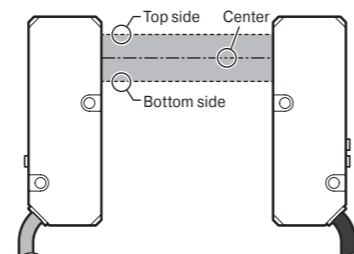

Values when "Positive" is selected: top side: -5.000 mm, bottom side: +5.000 mm, center: 0 mm
Values when "Negative" is selected: top side: +5.000 mm, bottom side: -5.000 mm, center: 0 mm

Moving Averaging

Moving average processing will be applied to the measured value for the specified number of times. You can set a value in the range of "1" to "128." If you specify a value of "1," average processing will not be performed. When measurement is not possible, the moving average processing is not updated.

Zeroing value

Check and change the Zeroing value.
* Settable range
"Edge" measurement: -5.000 to +5.000
"Width" measurement: 0 to +9.999

Direction Checking

You can check for and adjust the misalignment of the light axis in relation to the top and bottom directions when installing the heads.

Switching [Direction Checking] to "ON"

- For the operation method, see "5. Setting Menu Overview."
 - After you finish adjusting the light axis, switch [Direction Checking] to "OFF."
- If you return to the measured value display with this set to ON, measurement will not be possible, so the measured value will be displayed as "0000" or "9999."

With [Direction Checking] set to "ON," the Power indicator and alarm indicators of the receiving head light and flash according to the light receiving status. When light is received correctly, the Power indicator (green) and alarm indicator (red) on the receiving head both light.

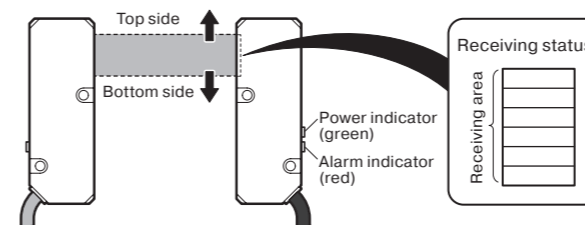

Misaligned to the top side

Misalignment	Receiving status	Display
Large	Receiving area	Power indicator (green): Lit continuously ☀️ Alarm indicator (red): Not lit ●
	Receiving area	Power indicator (green): Lit continuously ☀️ Alarm indicator (red): Flashing slowly ⚡
	Receiving area	Power indicator (green): Lit continuously ☀️ Alarm indicator (red): Flashing quickly ⚡
Small	Receiving area	Power indicator (green): Lit continuously ☀️ Alarm indicator (red): Flashing quickly ⚡

[Countermeasure]: Move the light axis to the bottom side.

Misaligned to the bottom side

Misalignment	Receiving status	Display
Small	Receiving area	Power indicator (green): Flashing quickly ⚡ Alarm indicator (red): Lit continuously ☀️
	Receiving area	Power indicator (green): Flashing slowly ⚡ Alarm indicator (red): Lit continuously ☀️
	Receiving area	Power indicator (green): Not lit ● Alarm indicator (red): Lit continuously ☀️
Large	Receiving area	Power indicator (green): Not lit ● Alarm indicator (red): Lit continuously ☀️

[Countermeasure]: Move the light axis to the top side.

Misaligned by half or more

Receiving status	Display
Receiving area	Power indicator (green): Not lit ● Alarm indicator (red): Not lit ●

Sensitivity

You can set the sensitivity to one of five levels. Normally, there is no problem with using this product with its default value of "2nd Sense". However, if measurements are unstable, such as due to a large distance between the emitting and receiving sides, increase the sensitivity level. Also, lower the sensitivity level if measurements are unstable due to the laser light passing through the measurement target. If the measurement target has a high transmittance and changing the sensitivity setting does not stabilize the measurement, select "Adjusted" with [Sensitivity], and then execute [Translucent Teach] from the Teach mode menu. This performs adjustments to match the installation status, enabling measurements of targets with transmittance of up to approximately 80%.
* "Adjusted" can only be selected when measuring edges.

Measure Direction

Set the target insertion direction when measuring the edges of transparent objects with [Sensitivity] set to "Adjusted."

Reset Settings

All setting items are returned to their factory default settings.

7. Teach mode

Details on teach mode

When you select [Zeroing], position the measurement target at the location where you want to set the displayed measured value to 0. When you select [Translucent Teach], keep the measurement target out of the measurement range. Then, press the [] button.

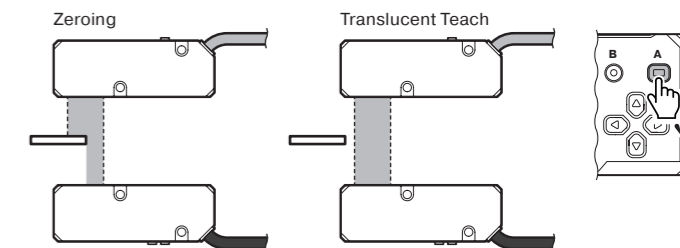

Zeroing

The current measured value is set as the offset value, and the current displayed measured value is set to 0.

Reset Zeroing

The Zeroing value is cleared. The measure value is returned to its current value.

Translucent Teach

Use this when "Adjusted" is selected with the [Sensitivity] setting item and edges of transparent objects are being measured. Perform teaching with the measurement target outside of the measurement range. The sensitivity will be adjusted to the optimal value. However, detection may not be possible in the case of highly transparent objects.

OPTEX FA CO.,LTD.

[Headquarters]
91 Chudoji-Awata-cho Shimogyo-ku Kyoto 600-8815 JAPAN
TEL +81-75-325-1314 FAX +81-75-325-2936

<https://www.optex-fa.com>