

*FASTUS is a product brand of Optrix FA.

Displacement sensor amplifier unit CDA series

User's manual

Compatible sensor

- Compact laser displacement sensor **CD22 series**
- Through-beam edge sensor **TD1 series**
- Ultra high-accuracy laser displacement sensor **CDX series**



Before using this product, please read this manual carefully.
Keep this manual at hand so that it can be used whenever necessary.
Store the manual in a secure location.

Introduction



Thank you for purchasing the **CDA series displacement sensor amplifier unit**. This manual contains the information necessary for using the **CDA series displacement sensor amplifier unit**. Read this manual thoroughly before using the product to ensure correct product use with full understanding of the functions and performance of the product. Also, after you have finished reading this manual, store it safely for future reference.

- Trademarks and registered trademarks appearing in this manual are the property of their respective owners.
- The copyright of this user's manual is owned by Optex FA Co., Ltd. All the contents contained herein are protected by copyright law. Unauthorized copying of this manual is strictly prohibited.





Safety Precautions

This manual uses the following symbols to display safety precautions for ensuring safe operation of the CDA series displacement sensor amplifier unit.











Precautions listed here describe important information about safety. Make sure to follow them accordingly.

■ Safety Symbols



The safety symbols and their meanings are as follows.

 Warning	Indicates that any improper operation or handling may result in moderate or minor injury, and in rare cases, serious injury or death. Also indicates a risk of serious property damage.
 Caution	Indicates that any improper operation or handling may sometimes result in moderate or minor injury or property damage.













■ Notes

 Warning	
	This product cannot be used as protective equipment for the purpose of protecting the human body.
	Do not disassemble, repair, modify, deform under pressure, or attempt to incinerate this product. Doing so may cause injury or fire.
	Do not use this product in water or in a location where it may be exposed to water. Do not use this product if wet. Doing so may cause a fire or damage the product.
 	This product is not explosion-proof and should not be used around flammable or explosive gases or liquids. Doing so may cause ignition resulting in an explosion or fire.
 	Do not use air dusters or any spray that uses flammable gas around the product or on the inside of the product. Doing so may cause ignition resulting in an explosion or fire.
	Do not install this product or its cables in any of the following locations. Doing so may cause a fire, damage, or a malfunction. <ol style="list-style-type: none"> 1. Locations where dust, salt, iron powders, or vapor (steam) is present. 2. Locations subjected to corrosive gases or flammable gases. 3. Locations where water, oil, or chemical splashes may occur. 4. Locations where heavy vibrations or impacts may occur. 5. Locations where the ambient temperature exceeds the rated range. 6. Locations subject to rapid temperature changes (or where condensation occurs). 7. Locations with strong electric or magnetic fields. 8. Outdoor locations or locations subject to direct light.
	Do not use the product at voltages or with AC power supplies that exceed the rated voltage. Doing so may cause a fire or damage the product.



! Warning

	<p>What to do in the event of a malfunction such as smoke being emitted from the product</p> <p>If you detect any malfunction including emission of smoke, abnormal smells or sounds, or the body becoming very hot, immediately stop operating the product and turn off the power. Doing so may cause a fire.</p> <p>Repairing the product is dangerous and should in no way be performed by the customer. Contact an Optex FA sales representative for repairs.</p>
	<p>What to do if water enters the product</p> <p>If water or any other liquid enters the product or the cable, immediately stop operating the product and turn off the power. Using the product in this condition may cause a fire.</p>

! Caution

	Do not touch the product or the cable with wet hands. Doing so may damage the product.
	Follow the instructions in this manual or the specified instruction manual when wiring the product or the dedicated controller for the correct wiring method. Incorrect wiring can damage the product or the controller, or cause a malfunction.
	Use the dedicated cable for connecting the product. Use of anything other than the dedicated cable may cause a malfunction or damage the product.
	Route wiring separately from high-voltage circuits and power circuits. If the wires are routed together, induction may occur, which can cause a malfunction or damage the product. If this is unavoidable, use a conductive object such as a properly grounded conduit as a shield.
	Install this product as far away from high-voltage equipment, power equipment, equipment that generates large switching surges, welders, inverter motors, or any equipment that can be a source of noise.
	Install the product and the dedicated controller securely. Ensure that any lock mechanisms available have been locked before use. Failure to ensure secure installation can result in the product falling and becoming damaged.
	Tighten mounting screws to the torque specified in this manual.
	Do not twist or apply stress to the cable. Doing so may damage the cable or the connector. In addition, install the cable while ensuring that the minimum bend radius or more is secured.
	Do not drop the product or subject the product to strong impacts. Doing so may damage the product.
	During operation, this product becomes very hot. Do not touch it for long periods of time. Doing so may cause a low-temperature burn.
	Use the product and dedicated controller within the rated ranges.
	Make sure to turn the power off before connecting or disconnecting the cable. Connecting or disconnecting while energized may damage the product.

Caution

	When connecting the cable, make sure to hold it by the connector portion, and do not apply excessive force to the cable.
	When disconnecting the connector, be careful not to touch the terminals inside the connector, and do not allow foreign objects to enter the connector.

■ Handling Precautions

1. After carefully considering the intended use, required specifications, and usage conditions, install and use the product within the specified ranges.
2. Due to advances in technology, published content, including the hardware, software, and system information published in this user's manual are subject to change without notice.
3. When using this product, it is the responsibility of the customer to ensure necessary safety designs in hardware, software, and systems in order to prevent any threat to life, physical health, and property due to product malfunction or failure.
4. This product is not intended for use with nuclear power, railways, aviation, vehicles, medical equipment, food-handling equipment, or any application where particular safety measures are required. Absolutely do not use this product for any of these fields.
5. This product cannot be used in applications that directly or indirectly detect human bodies for the purpose of ensuring safety. Do not use this product as a detection device for protecting the human body.
6. Do not use this product for the development of weapons of mass destruction, for military use, or for any other military application. Moreover, if this product is to be exported, comply with all applicable export laws and regulations, including the "Foreign Exchange and Foreign Trade Act" and the "Export Administration Regulations," and carry out the necessary procedures pursuant to the provisions therein.
7. For more details on conformity to the Restriction of Hazardous Substances Directive for this product, please contact an Optex FA sales representative.
Before using this product, fully examine the applicable environmental laws and regulations, and operate the product in conformity to such laws and regulations.
Optex FA does not assume any responsibility for damages or losses occurring as a result of noncompliance with applicable laws and regulations.

Related Manuals

The related manuals are shown below. Read the related manuals together with this one.

Manual name	Details
Displacement sensor amplifier unit CDA series instruction manual	This is the instruction manual included with the displacement sensor amplifier unit CDA series.
Small displacement sensor with digital display CD22 series Instruction manual	This is the instruction manual included with the small displacement sensor with digital display CD22 series (the model that supports RS-485 communication). Read this manual when connecting the CDA series to the CD22 series.
CC-Link Communication Unit UC1-CL11 User's manual	This is the user's manual for the CC-Link Communication Unit UC1-CL11. Read this manual when using the CDA as a relay to connect the compatible sensor to the UC1-CL11 and performing operations over a CC-Link network.
High-accuracy laser displacement sensor CDX series user's manual	This is the user's manual for the CDX series. Provides detailed information on CDX operation.
Through-beam edge sensor TD1 series user's manual	This is the user's manual for the TD1 series. Provides detailed information on TD1 operation.

Expressions Used in This Manual

This section explains the expressions used in this manual.

Caution

Indicates an item that requires special attention during operation

MEMO

Indicates information that is useful to know during operation

■ Abbreviations

Unless otherwise specified, the abbreviations shown below have the following meanings in this manual.

Abbreviation	Details
CDA	This indicates a CDA series ("CDA-□" □ followed by M, S, or DM2) displacement sensor amplifier unit.
Compatible sensor	This indicates a device that can be connected with a CDA unit, such as CD22, TD1, or CDX.
CD22	This indicates the small displacement sensor with digital display CD22 series (CD22-□□□- 485M12: "□□□" is "15," "35," or "100").
TD1	This indicates the TD1 series of through-beam edge sensors.
CDX	This indicates the CDX series of ultra high-accuracy laser displacement sensors.
UC1	This indicates the UC1 Filed Network Communication Units.

Contents

Introduction.....	i
Safety Precautions	ii
Related Manuals.....	v
Expressions Used in This Manual	v

1 Product Overview

1-1	Compatible Sensors	1-2
1-2	System Configuration Diagrams	1-2
1-3	Included Items	1-3
1-4	Optional Cables	1-3
1-5	Names and Functions of Parts	1-4
1-6	Connection and Installation Method	1-5
1-6-1	Connecting the CDA and the Compatible Sensor.....	1-5
1-6-2	Installation and Linking	1-7
1-6-3	Power Supply and I/O Wiring.....	1-8

2 Basic Operation Method

2-1	Operation Interface.....	2-2
2-1-1	Settings the First Time the CDA Starts	2-2
2-1-2	How to Operate the Setup Keys	2-3
2-1-3	Changing Settings.....	2-5

2-2	Screen Details	2-7
2-2-1	Display Screens	2-7

3 Common Settings for Various Functions

3-1	Setting Items and Menu Screen Transitions	3-2
3-2	Setting Items and Screen Transitions	3-3
3-2-1	APP Settings	3-3
3-2-2	I/O Settings	3-5
3-2-3	Channel Settings.....	3-7
3-2-4	AMP Expert Settings	3-9
3-3	Thickness.....	3-11
3-3-1	Thickness Measurement Procedure	3-12
3-3-2	Preparation	3-12
3-3-3	Setting the Reference Value and Tolerance.....	3-13
3-3-4	Executing the Distance Teaching.....	3-14
3-3-5	Setting the Distance between Heads by Entering a Numeric Value	3-15
3-3-6	Setting the Analog Output for the Calculated Thickness Value.....	3-15
3-3-7	Checking the Measurement Value	3-16
3-4	Level Difference	3-17
3-4-1	Level Difference Measurement Procedure	3-18
3-4-2	Preparation	3-18
3-4-3	Setting the Application	3-19
3-4-4	Executing the Level Difference Teaching.....	3-20
3-4-5	Enter a Numeric Value as a Level Difference Value	3-20

3-4-6	Setting a Tolerance	3-21
3-4-7	Setting the Analog Output for the Calculated Level Difference Value	3-22
3-4-8	Checking the Measurement Value	3-22
3-5	Calculation Settings	3-23
3-5-1	Setting the Calculation	3-25
3-5-2	Setting the Calculated Value Judgment	3-26
3-6	I/O Settings	3-29
3-6-1	Control Output Settings.....	3-29
3-6-2	Analog Output Settings	3-36
3-6-3	External Input Settings.....	3-42
3-7	Channel Settings	3-43
3-7-1	Baud Rate Settings	3-43
3-7-2	Setting Channel 2 to Not Be Used	3-44
3-8	Other Settings.....	3-45
3-8-1	Setting the I/O Polarity	3-45
3-8-2	Changing the Display Language.....	3-46
3-8-3	Initialization Settings	3-47
3-8-4	Correction Value Settings	3-48

4 Compatible Sensor Settings

4-1	CD22 Settings.....	4-2
4-1-1	Setting Items and Screen Transitions	4-2
4-1-2	Teaching.....	4-7
4-1-3	Alarm Settings for Measurement Error (When Measurement Is Not Possible)	4-13

4-1-4	Correcting the Influence of Sensor Light Axis Tilt	4-16
4-1-5	Initialization Settings	4-19
4-2	TD1 Settings	4-21
4-2-1	Setting Items and Screen Transitions	4-21
4-3	Measurement Type Setting	4-23
4-3-1	Edge Measurement and Width/Gap Measurement.....	4-23
4-3-2	Switching Between Edge Measurement and Width/Gap Measurement	4-24
4-4	Measurement Polarity Setting.....	4-25
4-4-1	Measurement Polarity Options.....	4-25
4-4-2	Measurement Polarity Setting	4-26
4-5	Measuring Transparent Objects.....	4-27
4-5-1	Sensitivity Adjustment For Transparent Objects	4-27
4-5-2	Measurement Direction Setting.....	4-28
4-6	Zero Teaching	4-30
4-6-1	Zeroing	4-30
4-6-2	Zeroing	4-32
4-6-3	Checking/Resetting Zeroing Value.....	4-33
4-7	CDX Settings	4-34
4-7-1	Setting Items and Screen Transitions	4-34
4-7-2	List of Setting Items	4-35
4-7-3	Analog Output Settings	4-37
4-7-4	Initialization Settings	4-39
4-8	Specifications.....	4-40
4-8-1	Specifications.....	4-40

4-8-2	Dimensions	4-41
4-8-3	I/O Circuit Diagrams.....	4-42

5 Appendix

5-1	Troubleshooting	5-2
5-1-1	Status Indicator Specifications.....	5-2



1

Product Overview

This chapter explains the procedures for connecting and installing the CDA and the compatible sensors, as well as giving a general overview of them.

- Compatible sensors
 - System configuration diagrams
- Included items
- Optional cables
- Names and functions of parts
- Connection and installation method
 - Connecting the CDA and the compatible sensors
 - Installation and linking
 - Power supply and I/O wiring

1-1 Compatible Sensors

These are sensors that can be connected to the CDA.



1-2 System Configuration Diagrams

CD22

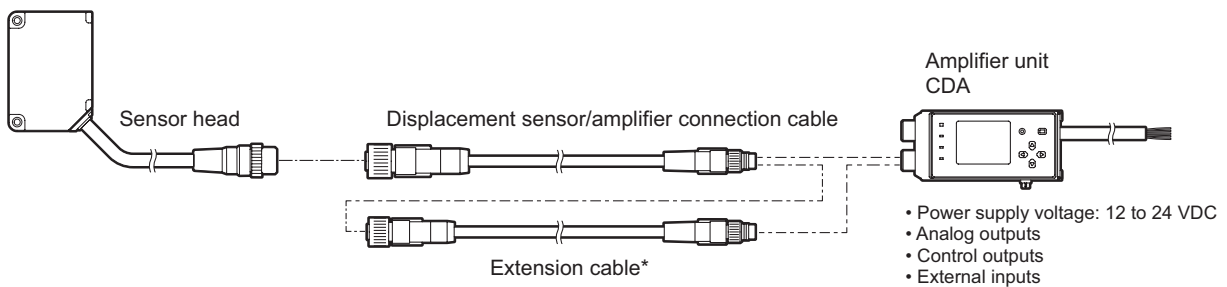

TD1

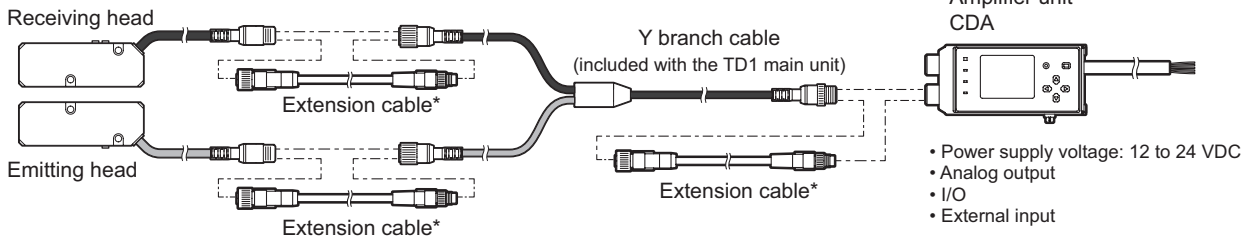

CDX

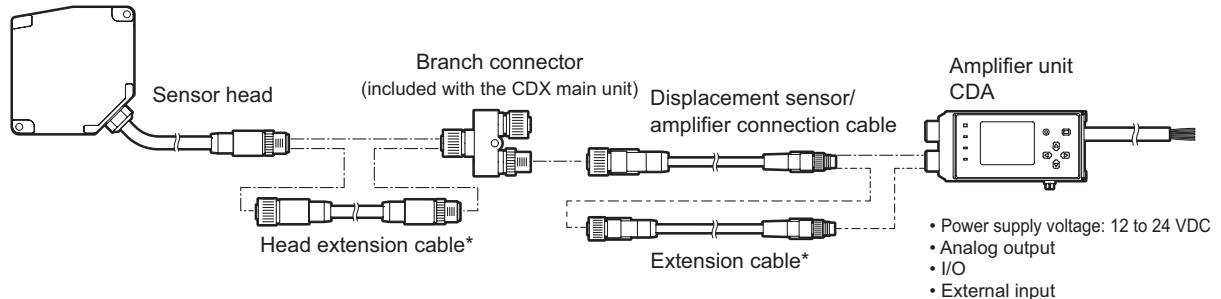

*: A cable required for extending the cable.

* CDX is not supported for Field Network communication via a UC1 adapter.

- The analog output and I/O specifications vary according to the amplifier unit model. See "4-8 Specifications" (page 4-40).

1-3 Included Items

Before using this product, confirm that the following items are contained in the package.

Amplifier unit ×1

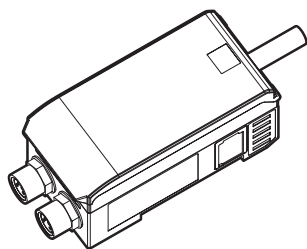

Instruction Manual ×1

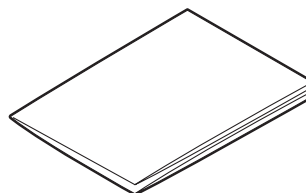

1-4 Optional Cables

● Displacement sensor/amplifier connection cable

Connector cable for connecting a sensor and amplifier unit. Robot cable specifications. M12 5-pin socket/M8 4-pin plug.

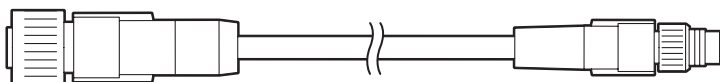

DSL-1204-G02M (2 m)

● Sensor-to-amplifier extension cable

Extension cable for connection to DSL-1204-G02M. Robot cable specifications. M8 4-pin socket/M8 4-pin plug.

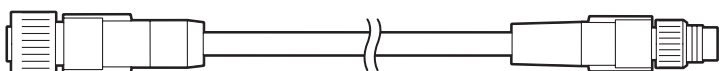

DSL-0804-G02M (2 m)

DSL-0804-G05M (5 m)

Caution

Ensure that the total cable length when connecting to a CDA series amplifier unit is within 10 m.

● Head extension cable (for CDX)

Dedicated cable for extension between the sensor head and branch connector. Extension up to 20 m is possible. Robot cable specifications. M12 8-pin socket/M12 8-pin plug.

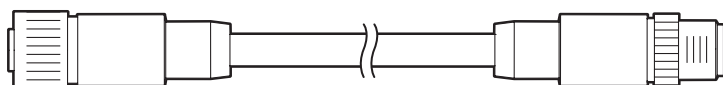

DSC-1208-G02MA (2 m)

DSC-1208-G05MA (5 m)

DSC-1208-G10MA (10 m)

1-5 Names and Functions of Parts

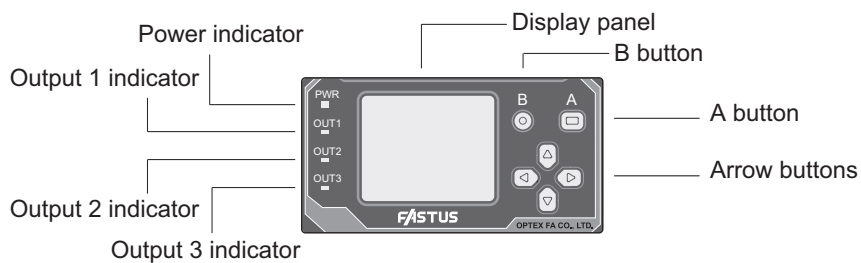
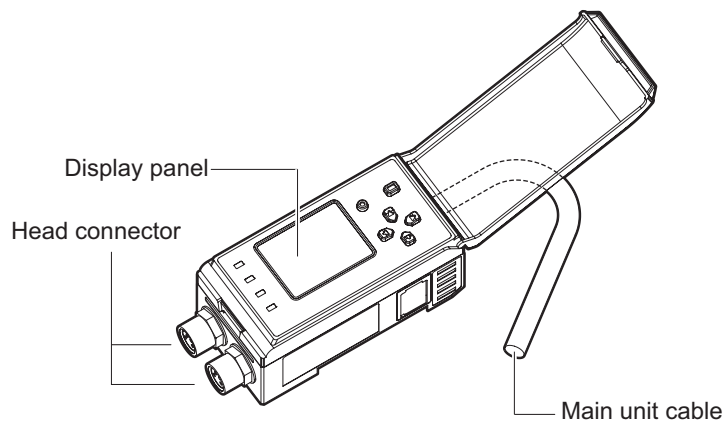

■ Indicators

Name	Color	Indication
Power indicator	Green/Red	Lit green: Power supply on Lit red: Head communication error Flashing green: In power-saving mode
Output 1 indicator	Orange	Lit: Output 1 is ON Off: Output 1 is OFF
Output 2 indicator	Orange	Lit: Output 2 is ON Off: Output 2 is OFF
Output 3 indicator	Orange	Lit: Output 3 is ON Off: Output 3 is OFF

■ Types and functions of buttons

Button shape	Name	On-screen display	Functions
	A button		Short press (less than 2 sec.): "Set"
			Long press (2 sec. or more): "Finish"
	B button		"Cancel"
	Up/Down buttons		Item selection, increasing/decreasing values
	Left/Right buttons		Menu selection

1-6 Connection and Installation Method

1-6-1 Connecting the CDA and the Compatible Sensor

This section explains the procedure for connecting the CDA and the compatible sensor. The CD22 is used as an example in this section.

Caution

Do not connect/disconnect the CDA and the compatible sensor when a power supply is connected. Connecting/disconnecting the devices while the power is on may lead to malfunctions.

MEMO

If you need to extend the cable, connect an extension cable (2 m or 5 m type) between the cable and the CDA head connector.

Follow the procedure shown below to connect the devices.

- 1** Connect the cable to the CD22, and then turn the connector on the cable side to lock it in place.

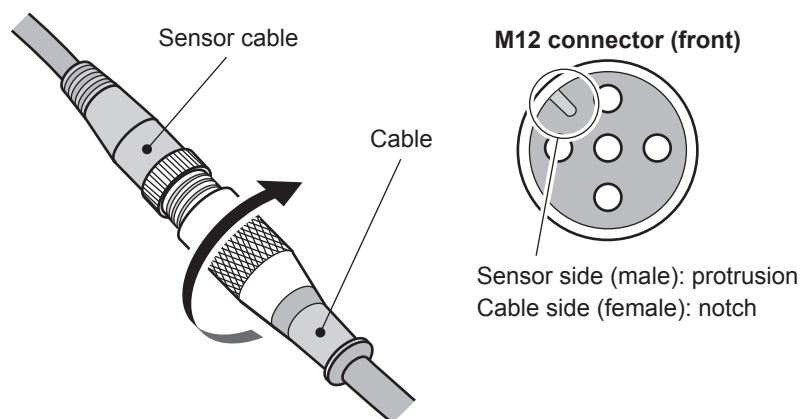

Align the protrusion on the M12 connector with the notch to connect the cable.

2 Connect the other connector (M8) of the cable connected to the CD22 to the CDA head connector, and then turn the connector on the cable side to lock it in place.

Check the orientation of the pins of the head connector of the channel that you are connecting to and of the M8 connector of the cable before establishing the connection.

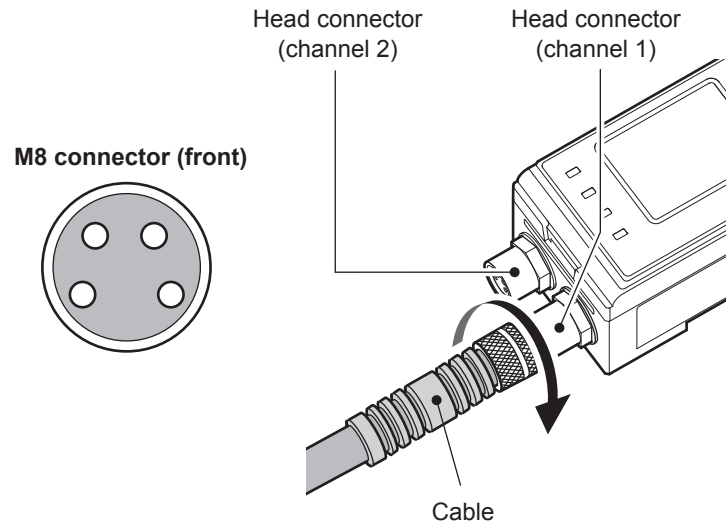

Caution

- When connecting or removing a sensor, do not use tools to turn the CDA head's connector fixing screw. In the event that this screw is removed, the CDA will need to be repaired.
- Avoid installing the CDA on a DIN rail while the CDA is connected to a compatible sensor. Doing so may apply unnecessary force to the cable.

Do not touch the head connector fixing screw.

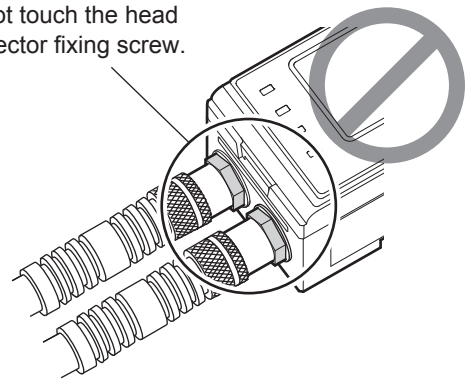

1-6-2 Installation and Linking

Install the CDA on a DIN rail. This section also explains how to link multiple CDAs together.

MEMO

- Ensure that the CDA is not connected to a power supply or to the compatible sensor before installing the CDA on or removing the CDA from a DIN rail.
- By linking a CDA with a UC1 adaptor on a DIN rail, you can operate the CDA and the compatible sensor that is connected to it over a field network. (The CDX is not supported for field network connection via a UC1 adaptor.) For details, see a related UC1 user's manual.

- 1** Align the DIN rail mounting hooks at the bottom on the rear of the CDA with the bottom side of the DIN rail. While pushing the CDA in the direction of (1) to press it onto the DIN rail, push the top of the CDA onto the DIN rail in the direction of (2).

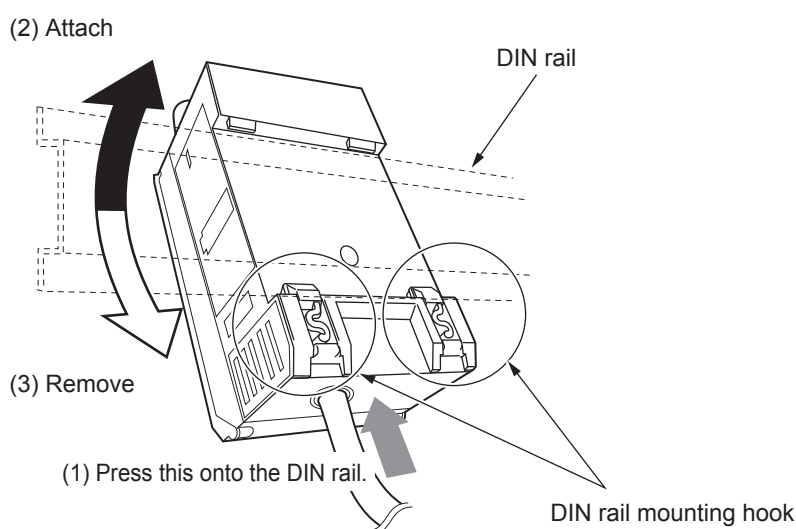

Check that the DIN rail mounting hooks are firmly locked and that the CDA is securely mounted on the DIN rail.

MEMO

To remove the CDA from the DIN rail, push the CDA in the direction of (1), and then push the top of the CDA off of the DIN rail in the direction of (3).

- 2** When linking together multiple CDAs, do so with them mounted on the DIN rail.

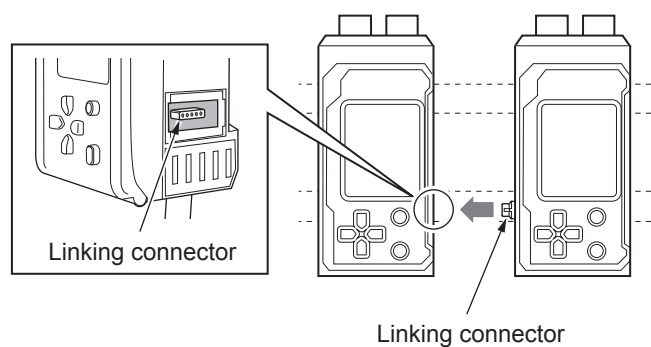

Caution

When linking the CDA with another unit (such as another CDA or a UC1) on a DIN rail, use the linking connectors to link the units together securely. If a linking connector is at an angle or is not firmly inserted all the way, the CDA or the other linked device may be damaged when the power is turned on.

- 3 To fix the units in place securely on the DIN rail, attach end plates (sold separately) to the DIN rail so that they surround the linked devices and fix the end plates in place with screws.**

Orient the end plates on each end of the linked devices so that the product side of each end plates faces the units, which means the right and left end plates face the opposite direction. Catch the notch of the end plate onto the DIN rail in order to attach the end plate.

The tightening torque for the screws is 0.9 N•m or less.

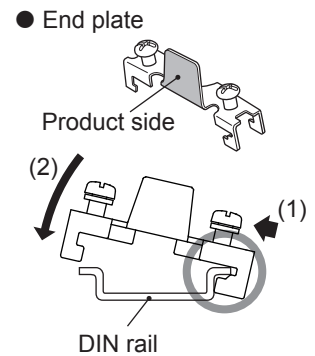

1-6-3 Power Supply and I/O Wiring

■ Connecting the power supply

Connect the power supply to the CDA.

When you connect the power supply to the CDA, power is supplied to the sensor by way of the head connector.

- 1 Connect the specified power supply to the brown (power supply +) and blue (GND) wires.**

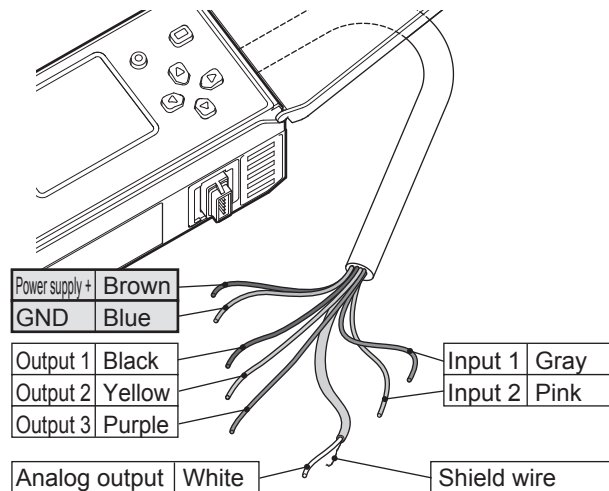

* The above figure shows the wiring of the CDA-M. For other models (CDA-DM2), see "Input and output wiring" (page 1-9).

Caution

- Before turning on the power, check that all the connections are complete. Also, turn the power supply off before performing wiring work such as switching and removing wires.
- When linking together multiple CDAs, you have to connect a power supply to each CDA as outlined above in order to supply power to the compatible sensors.

Input and output wiring

This section explains the connection of inputs and outputs with external devices.

- 1 Refer to "Connecting the power supply" (page 1-8) to make the required wiring connections of inputs and outputs.

CDA-M and CDA-S

Wire color	Details	Setting item
Brown	+V	DC12~24 V
Blue	GND	0 V
Gray	Input 1 (channel 1 external input)	[EXTIN Select] under [AMP I/O Settings]
Pink	Input 2 (channel 2 external input)	
Black	Output 1	[OUT1 Source] under [AMP I/O Settings]
Yellow	Output 2	[OUT2 Source] under [AMP I/O Settings]
Purple	Output 3	[OUT3 Source] under [AMP I/O Settings]
White	Analog output	[Analog Source] under [AMP I/O Settings]

* CDA-M and CDA-S units support analog current output.

CDA-DM2

Wire color	Details	Setting item
Brown	+V	DC12~24 V
Blue	GND	0 V
Purple	Input (external input)	[EXTIN Select] under [AMP I/O Settings]
Black	Output 1	[OUT1 Source] under [AMP I/O Settings]
Yellow	Output 2	[OUT2 Source] under [AMP I/O Settings]
White	Analog output 1	[Analog1 Source] under [AMP I/O Settings]
Pink	Analog output 2	[Analog2 Source] under [AMP I/O Settings]

* For CDA-DM2 units, analog output of either current or voltage can be selected per channel.

MEMO

- The function assigned to external input is common to channel 1 and channel 2. You cannot assign a different function to each channel.
- For the external I/O settings, see "3-2-2 I/O Settings" (page 3-5).





2

Basic Operation Method

This chapter explains the points needed for operation.

- Settings the first time the CDA starts
- How to Operate the Setup Keys
- Screen details

2-1 Operation Interface

2-1-1 Settings the First Time the CDA Starts

The first time that you turn on the CDA after you purchase it, a screen for setting the display language is displayed.

Follow the procedure shown here to set the display language.

MEMO

You can change the display language later from the CDA's [AMP EXP Settings] menu.

- 1 Use Δ or ∇ to select [Japanese: 日] or [English: 英].

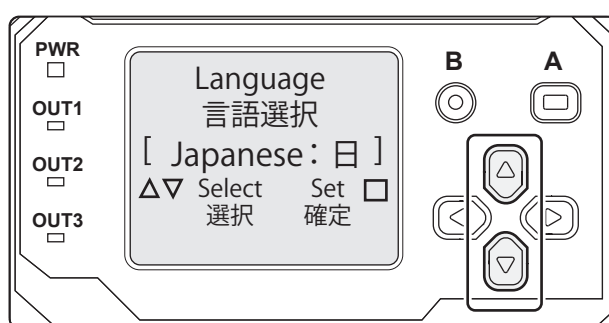

- 2 Press \square (A).
The display language setting is confirmed and the basic screen is displayed.

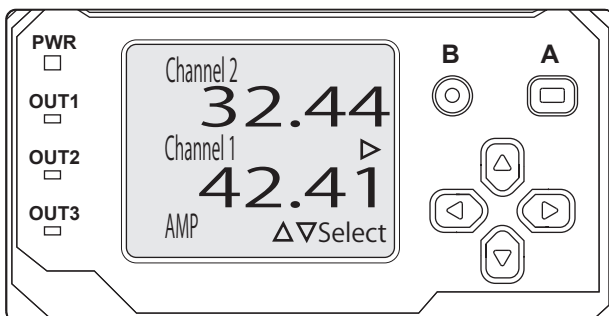
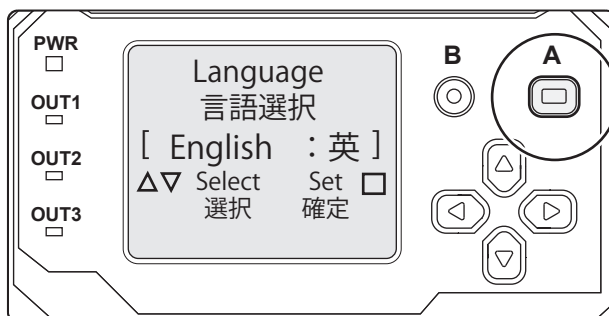

2-1-2 How to Operate the Setup Keys

The following section explains how to operate the setup interface of the CDA.

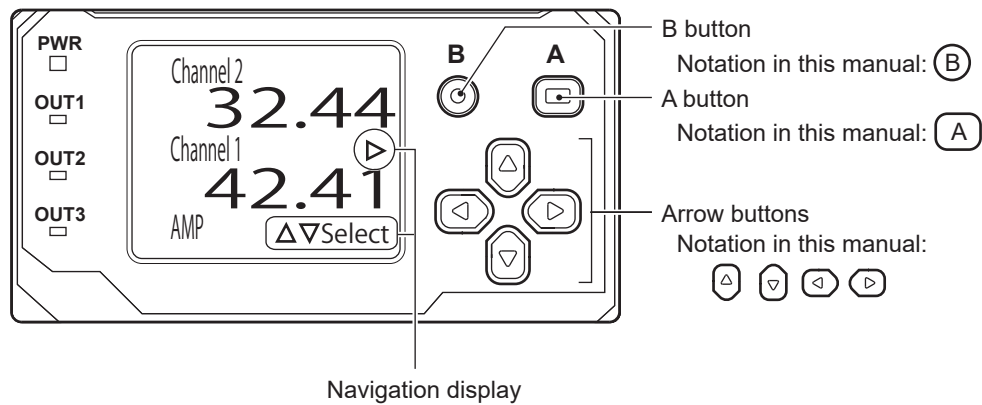

Navigation display		This displays the buttons that can be operated on and the operation details for the displayed screen.
	△▽◀▶	Displays the details of the operation that can be performed with the arrow buttons.
	□	Displays the details of the operation that can be performed with the A button.
	■	Displays the details of the operation that can be performed by holding down the A button.
	○	Displays the details of the operation that can be performed with the B button.
Operation buttons	A button	This is mainly used to confirm and set items.
	B button	This is mainly used to return to the previous screen.
	Arrow buttons	These are used to select items, switch between screens, and increase/decrease numeric values.

MEMO

- In actuality, the display panel is black and the characters and figures are displayed in white on it. For example, "□" in the navigation display is actually a square drawn in white and "■" is actually a square that is filled in white.
- If no operations are performed for approximately 10 minutes, the CDA's power-saving function turns the screen display off. The [PWR] LED flashes in green. In this mode, press any of the operation buttons to return to the basic screen or calculation screen that was displayed when the display turned off.

MEMO

- As shown in the following operation example, you may be able to move the frame to a digit that is not displayed.

■ **Example: Setting "Clamp holding time" to a four-digit numeric value**

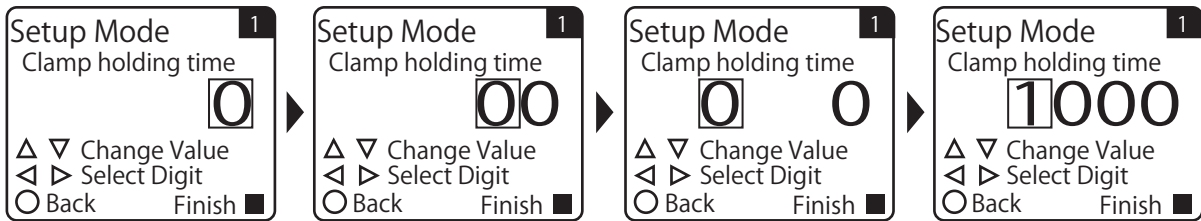

As shown in the above figure, this item's default value is "0."

When you press **(◀)** once, the frame moves to the digit on the left, and "0" is displayed.

When you press **(◀)** two more times, the frame moves to the thousands position. The digits between the ones position and the thousands position are not displayed.

When you press **(▲)** to change the thousands position to a numeric value other than "0," the intermediate digits are displayed as "0."

- If you press **(B)** before pressing **(A)** to confirm the changed numeric value that you are setting, the change will be canceled and you will return to the setting screen.
-

2-1-3 Changing Settings

Regarding operations for configuring settings from the CDA, you can use the arrow keys to change the selected item and you can use the arrow keys to change the setting's numeric value.

■ Changing the selected item

In this section, the teaching mode of the CD22 connected to the CDA will be changed as an example for explaining how to change the selected item.

- 1 On the basic screen, press \uparrow or \downarrow to select [Channel 1] or [Channel 2], and then press A .

The Setup Top Menu for the selected channel is displayed.

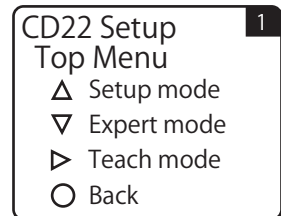

- 2 Press A .

The display switches to the [Setup Mode] menu.

- 3 Use \leftarrow or \rightarrow to switch to the [Teaching Mode] screen.

The default value for the CD22 teaching mode is [2-Point]. The setting has been confirmed with these details, so the setting item is displayed with double brackets ([[]]) to indicate this, as shown in the figure.

The double brackets ([[]]) indicate that the selected item has been confirmed.

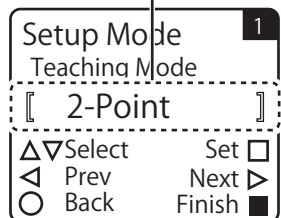

- 4 Use \uparrow or \downarrow to switch the setting item.

For the CD22, you can select the teaching mode from [2-Point], [1-Point], and [FGS2 Distance].

Just selecting an option does not confirm the setting. The setting item is displayed with brackets ([]) to indicate that it has not been confirmed, as shown in the figure.

The brackets ([]) indicate that the selected item has not been confirmed.

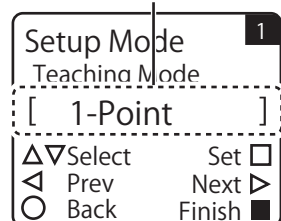

- 5 Press A .

The changed setting is confirmed, and the setting item is displayed with double brackets ([[]]) again to indicate this.

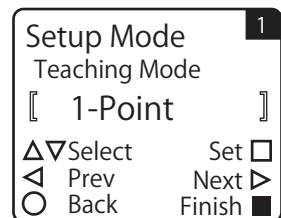

MEMO

- Hold down A on any menu to return to the basic screen.
- On the setting screen where you are changing the selected item, if you press a different button before pressing A to confirm the changed setting, you will return to the Top Menu with the setting details from before the change you made.

■ Changing a setting's numeric value

In this section, the far end distance of the CD22-100□□ will be changed as an example for explaining how to change a setting's numeric value.

- 1** On the basic screen, press  or  to select [Channel 1] or [Channel 2], and then press .

The Setup Top Menu for the selected channel is displayed.

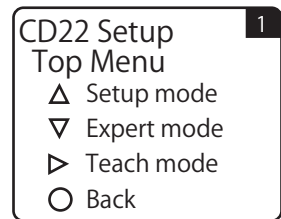

- 2** Press .

The display switches to the [Setup Mode] menu.

- 3** Use  or  to switch to the [Far End distance] screen.

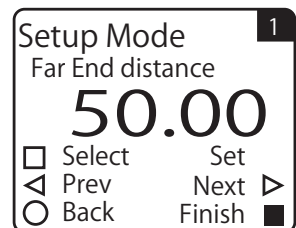

The default value for the CD22-100□□ far end distance is 50.00.



- 4** Press .

You can now change the numeric value.

The navigation display switches, and the right-most digit of the displayed numeric value is enclosed in a frame.

- 5** Use  or  to move the frame to the digit whose value you want to change.

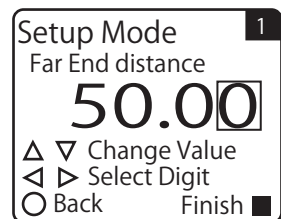

- 6** Use  or  to change the numeric value.

: Increase the numeric value.

: Decrease the numeric value.

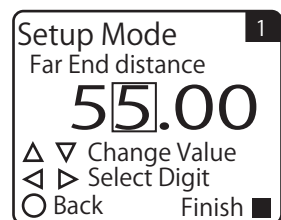

- 7** When you are finished changing the numeric value, press .

The changed numeric value is confirmed, and the frame disappears.

2-2 Screen Details

2-2-1 Display Screens

The CDA has three types of display screens (basic screen, sensor setting screen, and amplifier setting screen).

■ Basic screen (measurement value display)

This screen is the CDA's start screen after you make the initial language setting. Generally, the measurement value of the connected sensor will be displayed.

- If a sensor is connected to channel 1 or channel 2, the current measurement value is displayed.
- By switching between menus, you can switch the display between the settings of the connected sensor and CDA and the calculation. (It is possible to transition to the sensor setting screen or amplifier setting screen.)

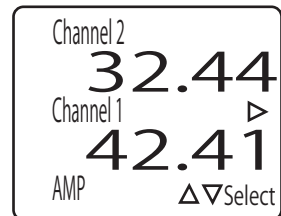

■ Sensor setting screen

This screen is used to change the connected sensor settings. The displayed details change depending on the connected sensor.

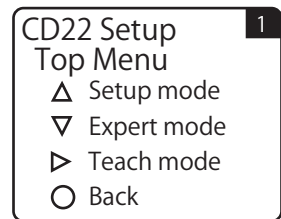

* As an example, the operation is performed with the CD22 connected.

■ Amplifier setting screen

This screen is used to change the CDA settings. This is mainly used to change applications and set input/output.

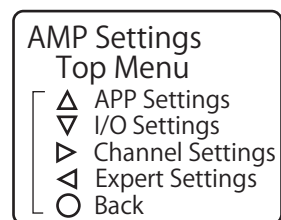

Switching to the sensor setting screen or amplifier setting screen

Follow the procedure shown below to switch the display between the screens used to set the CDA and the connected sensor.

1 On the basic screen, press Δ or ∇ .

The cursor (\blacktriangleright) will be displayed on the left side of the basic screen, and the navigation display will be switched.

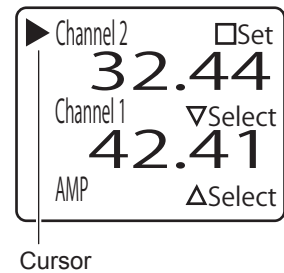

2 Use Δ or ∇ to move the cursor and switch the target that you want to set.

Channel 2	Set the sensor connected to CDA channel 2 separately.
Channel 1	Set the sensor connected to CDA channel 1 separately.
AMP	Set the amplifier.

3 Press A .

The display switches to the [Top Menu] screen of the selected setting target.

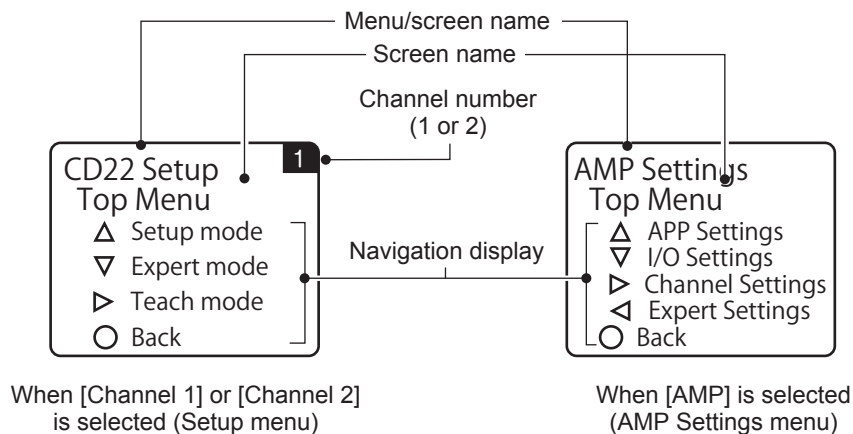

* As an example, the operation is performed with the CD22 connected.

MEMO

- When you perform the operation to return to the basic screen from a channel 1 or channel 2 setting screen, the display returns to the basic screen with the cursor shown at the channel that you were setting. When you perform the operation to return to the basic screen from an amplifier settings screen, the cursor is not shown when the display returns to the basic screen.

When you return to the basic screen from a channel 2 setting screen

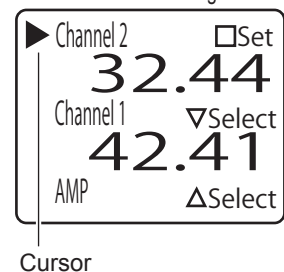

Switching to the calculation screen

You can switch from the basic screen to the calculation screen.

1

On the basic screen, press .

The display switches to the calculation screen.

Press  or  on the calculation screen to return to the basic screen.

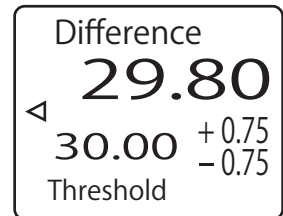
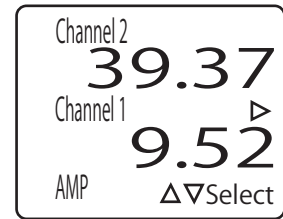

Display of the calculated value when measuring the level difference

MEMO

- The displayed contents of the calculation screen vary depending on the CDA's [APP Settings]. In the example shown above, [APP Settings] is set to [Difference].
- If you set the CDA's app settings to [Not use] and each channel's calculation setting to [Not use], the calculation screen will appear as shown in the figure on the right.

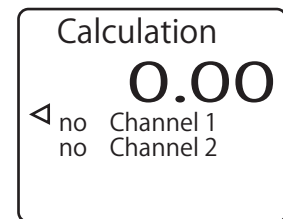

Display when measurement is not possible and when no sensor is connected

When no compatible sensor is connected to the CDA's head connector, the display for the corresponding channel is "-----." You cannot use the cursor to select a channel to which a compatible sensor is not connected. Also, if the measurement value of a compatible sensor connected to the CDA is outside of the measurement range, "9999" is displayed with the character and background colors inverted.

In the same way, if a calculation result exceeds the displayable range, "32767" is displayed with the character and background colors inverted.

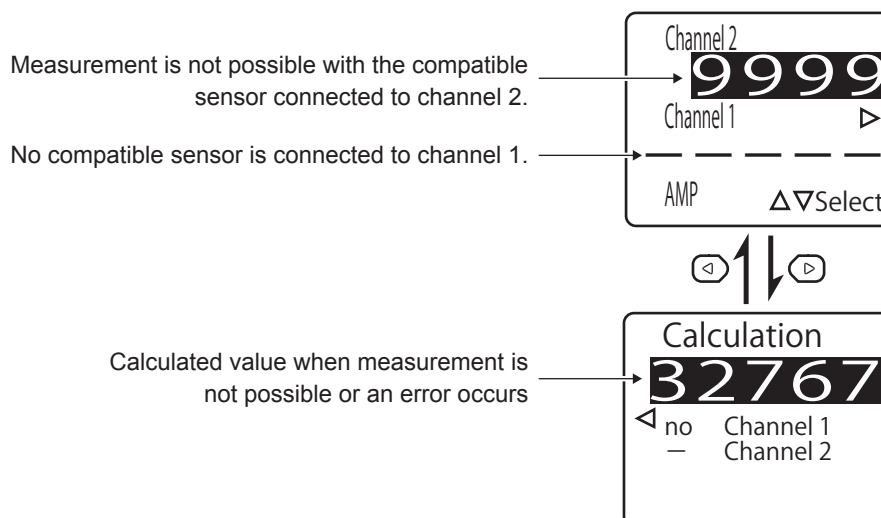

■ Locking the CDA operation buttons

You can lock the CDA operation buttons to prevent the settings from being changed by mistake.

1 Display the basic screen or the calculation screen.

2 Hold down **(B)** (for 2 seconds or more).

The keys are locked. On the basic screen, "Key Locked" is displayed at the bottom of the screen and the navigation display disappears. On the calculation screen, the navigation display disappears.

To release the key lock, hold down **(B)** (for 2 seconds or more) again.

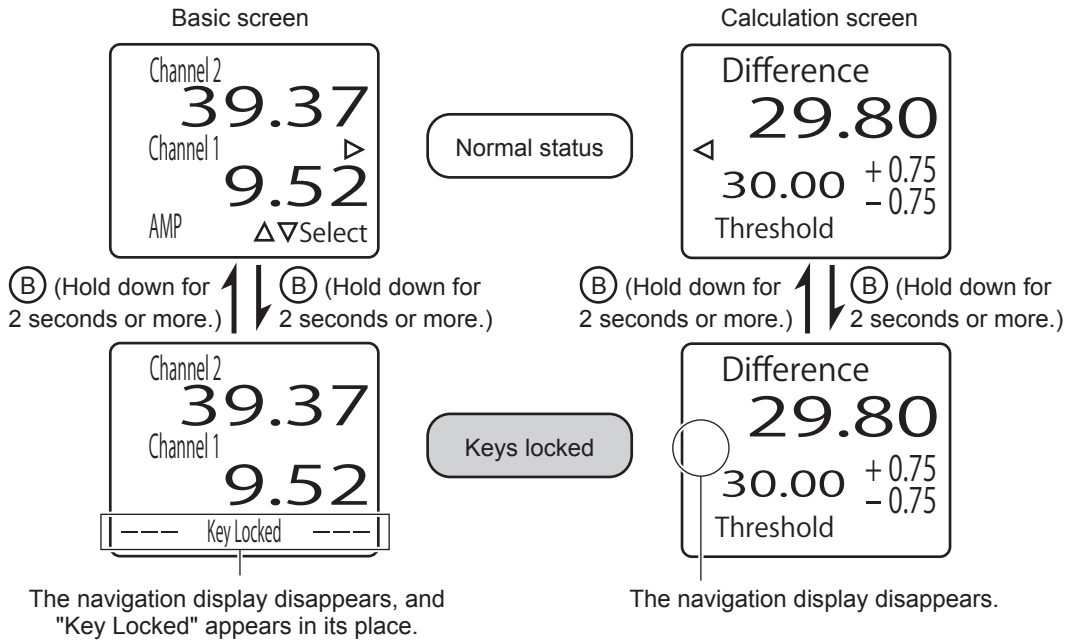

3

Common Settings for Various Functions

This chapter explains the CDA menus and setting items.

- Setting items and menu screen transitions
- APP settings
 - Thickness
 - Level Difference
 - Calculation settings
- I/O settings
 - Control output settings
 - Analog output settings
 - Analog scaling settings
 - External input settings
- Channel settings
 - Baud rate settings
- Other settings
 - I/O polarity (PNP/NPN)
 - Language
 - Initialization

3-1 Setting Items and Menu Screen Transitions

Configure the CDA settings by selecting [AMP] from the "basic screen."
There are four types of setting items.

■ Amplifier unit channel selection menu

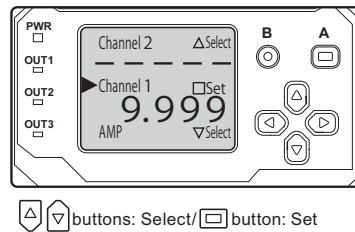

[To connected sensor Top Menu]
Select the channel for which the settings will be changed.

▲▼ buttons: Select/□ button: Set

■ Amplifier unit Top Menu

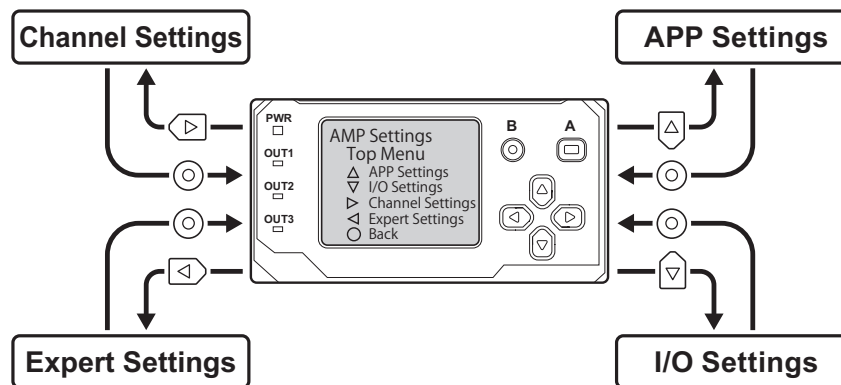

Channel Settings

This configures the settings of the connected sensor's baud rate (the communication speed between the CDA and the sensor) and the correction parameters.

→ For details of setting items and screen transitions, see "Channel Settings" (page 3-7).

APP Settings

This configures the settings related to the level difference measurement and thickness measurement.

→ For details of setting items and screen transitions, see "APP Settings" (page 3-3).

Expert Settings

This configures the settings for calculation, threshold, hysteresis, initialization, and switching language.

→ For details of setting items and screen transitions, see "AMP Expert Settings" (page 3-9).

I/O Settings

This configures the settings related to control output, analog output, external input, and I/O polarity.

→ For details of setting items and screen transitions, see "AMP Expert Settings" (page 3-9).

3-2 Setting Items and Screen Transitions

3-2-1 APP Settings

■ Setting items

Screen name	Explanation and settable values/options
Application Sel	<p>Set the application of the sensor connected to the CDA.</p> <p>Not use: Use this when you are using a calculation for the measurement value of each of the two channels.</p> <p>Difference: Measure the workpiece's level difference from the measurement values of the two channels. See "Level Difference" (page 3-17).</p> <p>Thickness: Measure the workpiece's thickness from the measurement values of the two channels. See "Thickness" (page 3-11).</p> <p>Independent: The two channels are measured independently and no calculation is performed between them. The [I/O Settings] are changed automatically to the following values (which can be changed).</p> <ul style="list-style-type: none"> • [OUT1 Source]: [Go Ch1 Result] • [OUT2 Source]: [Go Ch2 Result]
Analog Source	<p>Set the analog output assignment when [Application Sel] is set to [Independent].</p> <p>Not use^{*1}/Channel 1/Channel 2^{*1}/Head 1^{*2}/Calculation^{*2}</p>
Thickness Value	<p>Enter the judgment reference (the target thickness).</p> <p>0 to 100.00</p>
Upper Limit	<p>Enter the error value to use as the upper limit of the allowable thickness.</p> <p>-327.68 to 0.50 to 327.67 (327.67 - Thickness Value)</p>
Lower Limit	<p>Enter the error value to use as the lower limit of the allowable thickness.</p> <p>-327.68 to -0.50 to 327.67 (327.67 - Thickness Value)</p>
Teaching Distance	<p>See "Thickness" (page 3-11).</p>
Head Distance ^{*3}	<p>Enter the distance between two sensors that are installed facing each other.</p>
Analog Source	<p>Set the analog output assignment when [Application Sel] is set to [Thickness]. When you select [Active], the calculated thickness value is output.</p> <p>Not use/Active</p>
Difference Teach	<p>See "Level Difference" (page 3-17).</p>
Difference Value	<p>Enter the judgment reference (the target level difference).</p> <p>-100.00 to 0.00 to 100.00</p>
Upper Limit	<p>Enter the upper limit of the allowable level difference error.</p> <p>-327.68 to 0.50 to 327.67 (327.67 - Difference Value)</p>
Lower Limit	<p>Enter the lower limit of the allowable level difference error.</p> <p>-327.68 to -0.50 to 327.67 (327.67 - Difference Value)</p>
Analog Source	<p>Set the analog output assignment when [Application Sel] is set to [Difference]. When you select [Active], the calculated level difference value is output.</p> <p>Not use/Active</p>

* The default values are shown in bold.

*1 Items only for CDA-M

*2 Items only for CDA-DM2

*3 The decimal position of the set value changes according to a connected sensor.

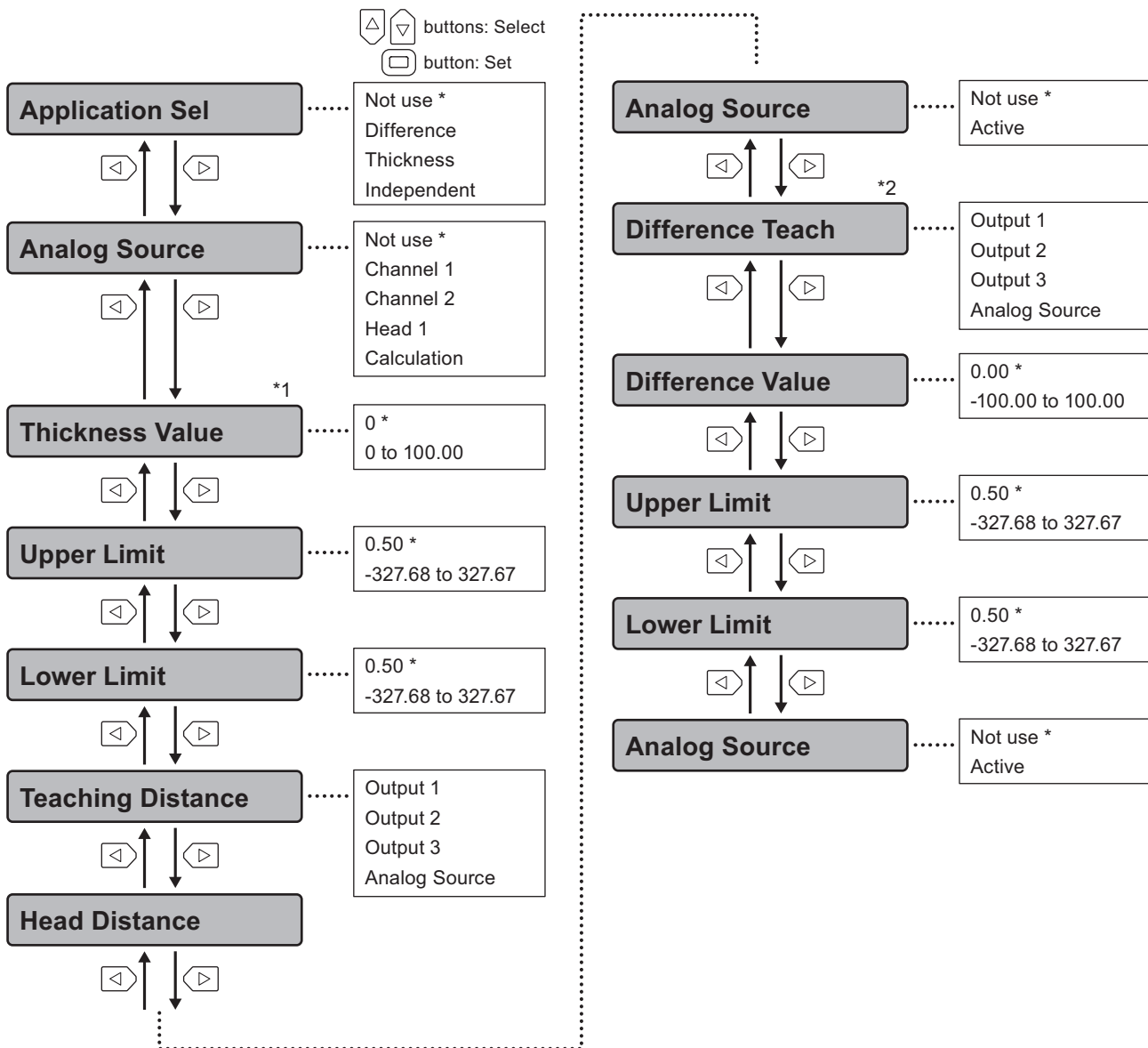

■ Screen transitions

* is the default value of each setting item.



This is the default value of [Application Sel]. After you select the application, the set details become those of the first screen displayed when you press  on the Top Menu.

*1: If you set [Application Sel] to [Thickness], this is displayed first when you press .

*2: If you set [Application Sel] to [Difference], this is displayed first when you press . You cannot press to  switch from the [Difference Teach] screen to the [Analog Source] screen.

●●● MEMO ●●●

After you confirm the selected application on the [Application Sel] screen, press  to switch to the menu for the confirmed application. If an application is not confirmed, pressing this button will switch the screen to the previously selected application.

3-2-2 I/O Settings

■ Setting items

Screen name	Explanation and setting items
OUT1 Source	Set the assignments for each of the three control outputs.
OUT2 Source	Not use /Go Calculation/Lo Calculation/Hi Calculation/Go Ch1 Result/Lo Ch1 Result/Hi Ch1 Result/Go Ch2 Result/Lo Ch2 Result/Hi Ch2 Result
OUT3 Source* ¹	
EXTIN Select	Set the external input function. Not use /Teach mode/BGS/FGS Teach/Offset Set/Laser OFF
Analog Source* ²	Set the details to assign to analog output. Not use /Calculation/Channel 1/Channel 2
Analog Scaling* ²	Set whether to apply the scaling settings to the analog output when performing analog output with [Analog Source] set to a value other than [Not use]. Active/ Not use
Analog1 Type* ³	Select the output method of analog output 1 with current/voltage. Current: 4 to 20 mA / Voltage: 0 to 10 V
Analog1 Source* ³	Set the details to assign to analog output 1. Channel 1/Channel 2/Calculation
Scaling Max1* ³	Set the measurement value when the analog output 1 is 20 mA, 10 V. Input range: -32768 to 32767
Scaling Min1* ³	Set the measurement value when the analog output 1 is 4 mA, 0 V. Input range: -32768 to 32767
Analog2 Type* ³	Select the output method of analog output 2 with current/voltage. Current: 4 to 20 mA / Voltage: 0 to 10 V
Analog2 Source* ³	Set the details to assign to analog output 2. Channel 1/Channel 2/Calculation
Scaling Max2* ³	Set the measurement value when the analog output 2 is 20 mA, 10 V. Input range: -32768 to 32767
Scaling Min2* ³	Set the measurement value when the analog output 1 is 4 mA, 0 V. Input range: -32768 to 32767
Scaling Max* ²	Set the value during 20 mA output when [Analog Scaling] is set to [Active]. -32768 to 10000 to 32767
Scaling Min* ²	Set the value during 4 mA output when [Analog Scaling] is set to [Active]. -32768 to -10000 to 32767
I/O Polarity	Set the I/O polarity (the indicators light when output is on). NPN (N.O.) /PNP (N.C.)/NPN (N.C.)/PNP (N.O.)

* The default values are shown in bold.

*1 As there is no connection with OUT3 on the CDA-DM2, the setting in this menu on the CDA-DM2 will not affect the output.

*2 Items only for CDA-M

*3 Items only for CDA-DM2

Screen transitions

* is the default value of each setting item.

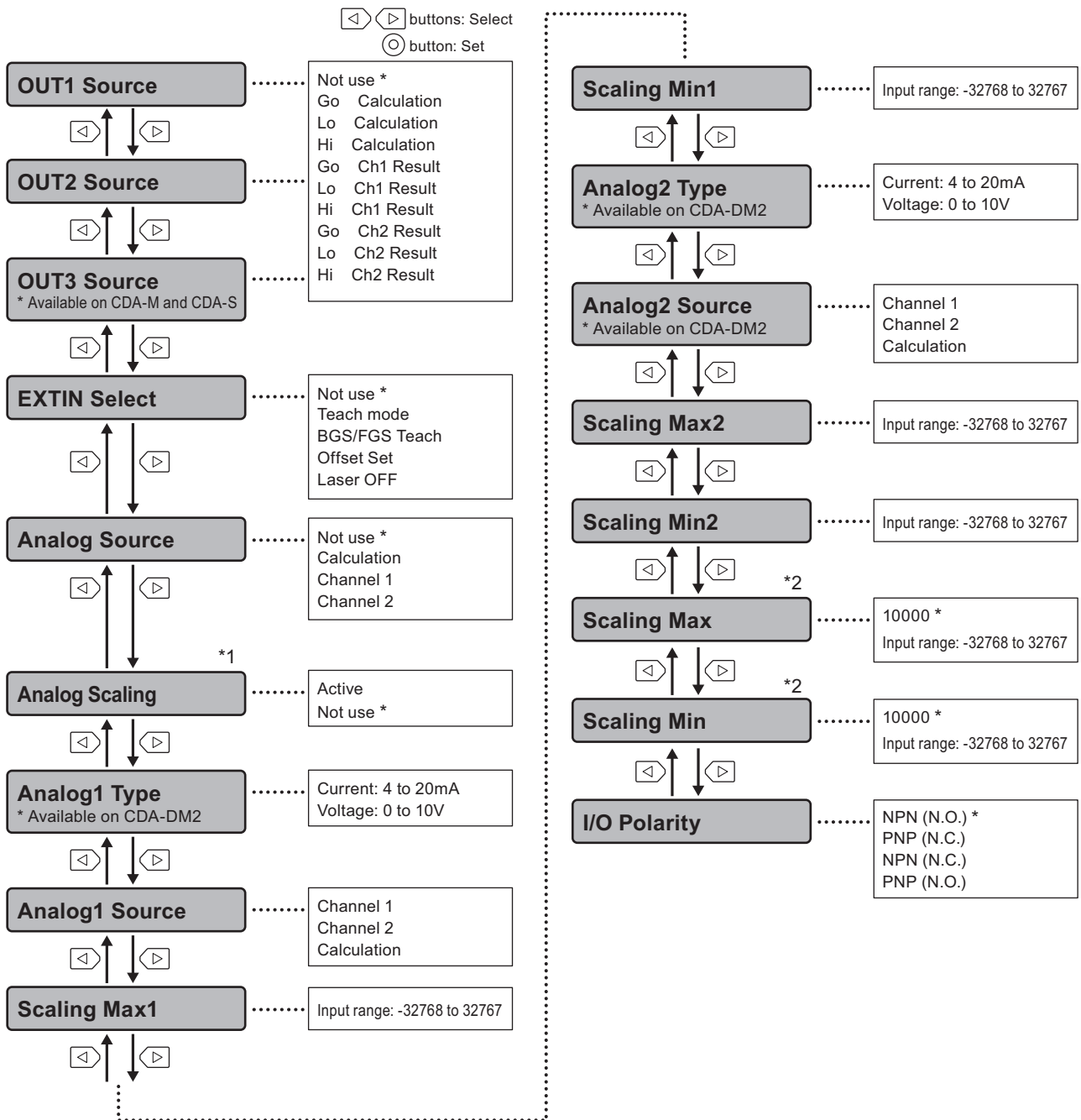

This is the first screen displayed for the [AMP I/O Settings] menu immediately after the power is turned on or after you initialize the settings. Thereafter, the last menu that you used is displayed.

*1: This is only displayed when you set [Analog Source] to a value other than [Not use].

*2: This is only displayed when you set [Analog Scaling] to [Active].

3-2-3 Channel Settings

■ Setting items

The settings are independent for each channel.

Screen name	Explanation and setting items
Select Channel	Select the channel to set. Channel 2/Channel 1
Baudrate	Set the communication speed between the CDA and the sensor. Not use/9.6 kbps/19.2 kbps/38.4 kbps/57.6 kbps/115.2 kbps/230.4 kbps/312.4 kbps/468.8 kbps/500.0 kbps/ 625.0 kbps /833.3 kbps/937.5 kbps/1250 kbps
Correction	Set whether to correct the input from the sensor. Not use /APPLY
A1: M1 (A1 + Ch1)/D1	Set correction parameter A (the addition coefficient) of channel 1. -10000 to 0 to 10000
M1: M1 (A1 + Ch1)/D1	Set correction parameter M (the multiplication coefficient) of channel 1. -10000 to 1 to 10000
D1: M1 (A1 + Ch1)/D1	Set correction parameter D (the division coefficient) of channel 1. 1 to 32767
A2: M2 (A2 + Ch2)/D2	Set correction parameter A (the addition coefficient) of channel 2. -10000 to 0 to 10000
M2: M2 (A2 + Ch2)/D2	Set correction parameter M (the multiplication coefficient) of channel 2. -10000 to 1 to 10000
D2: M2 (A2 + Ch2)/D2	Set correction parameter D (the division coefficient) of channel 2. 1 to 32767

* The default values are shown in bold.

MEMO

- If no sensors are connected to the channels, the CDA will be "unconnected" and its PWR LED will light in red to indicate an error. If a sensor is not connected to a channel, you can prevent the unconnected channel error by setting the channel's [Baudrate] to [Not use].
- For details on the correction setting and the correction parameters, see "Correction Value Settings" (page 3-48).

■ Screen transitions

* is the default value of each setting item.

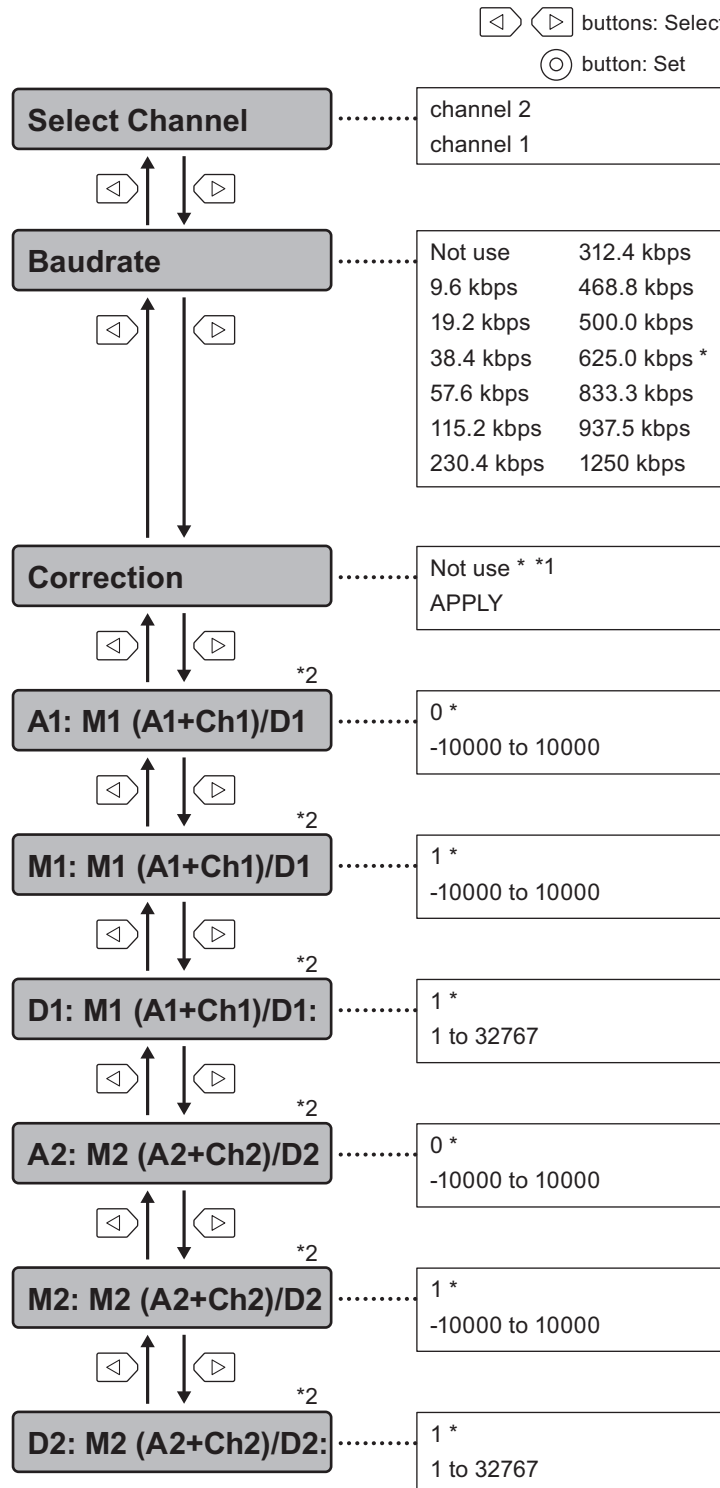

This is the first screen displayed for the [Channel Setting] menu immediately after the power is turned on or after you initialize the settings. Thereafter, the last menu that you used is displayed.

1: An asterisk () indicates the default value of [Correction]. When [Not Use] is selected, you can use the ◀ key or the ▶ key to switch to the [Baudrate] screen and [Correction] screen.

*2: This is only displayed when [APPLY] is selected for [Correction].

3-2-4 AMP Expert Settings

■ Setting items

Screen name	Explanation and setting items
Ch1 Calculation	See "Calculation Settings" (page 3-23).
Ch2 Calculation	Not use /+ Addition/- Subtraction/- Abso Sub
Left Ch1 Calc* ¹	When the CDA is linked with other units, you can use the measurement values of the channels of the neighboring CDA on the left as references in the calculations. Not use /+ Addition/- Subtraction/- Abso Sub
Left Ch2 Calc* ¹	
Near Threshold	Set the lower limit that is used when controlling judgment output. -32768 to -50 to 32767
Far Threshold	Set the upper limit that is used when controlling judgment output. -32768 to 50 to 32767
Hysteresis	Set the hysteresis that is used when controlling judgment output. 0 to 10 to 32767
Monitor Calc* ²	Assign the calculated value's output source. Ch2 Measure/Calculated Val
Reset Settings	Reset all the CDA settings to their default values. Not Reset /Execute by <input type="checkbox"/>
Language	Select the display language. Japanese/English

* The default values are shown in bold.

*1 Items only for CDA-M

*2 When you are referencing calculated values over a field network, select [Calculated Val]. However, this will make channel 2 handle calculated values, so you will not be able to directly reference the measurement values of channel 2.

■ Screen transitions

* is the default value of each setting item.

◀ ▶ buttons: Select
⊙ button: Set

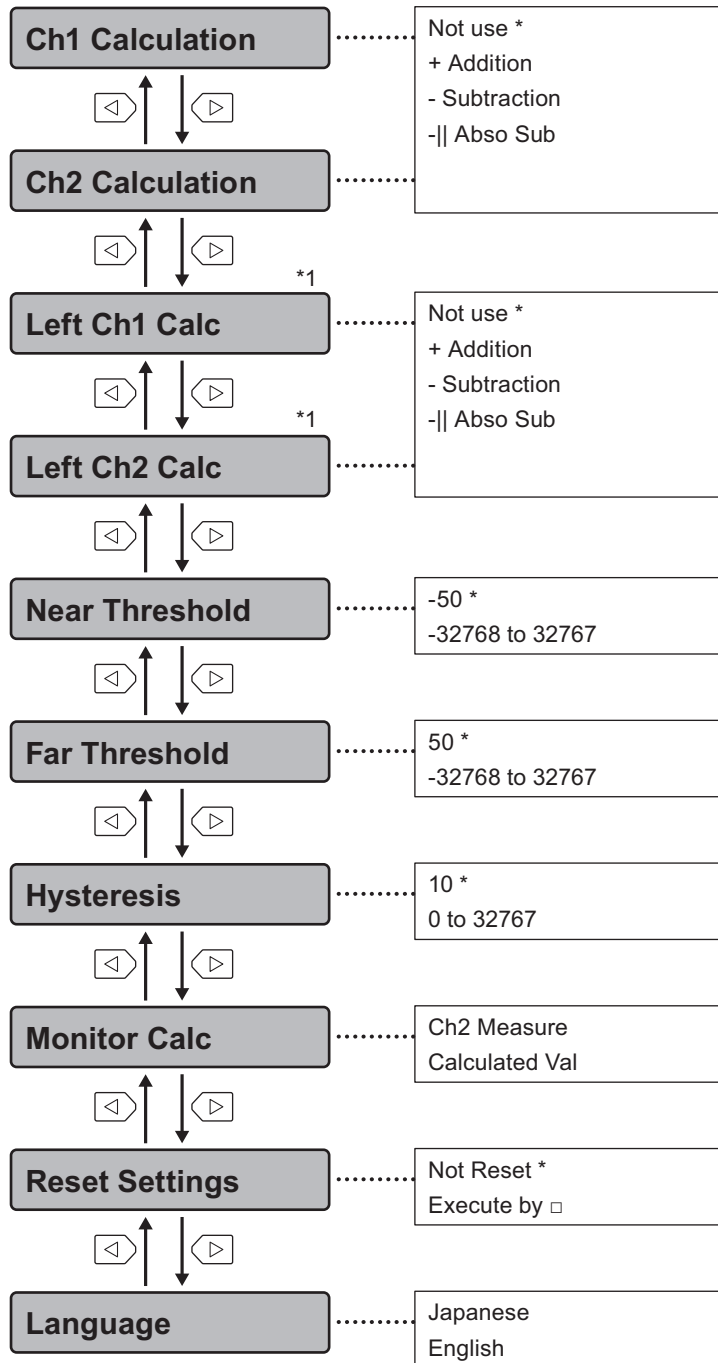

Immediately after the power is turned on, this is the first screen displayed for the [AMP EXP Settings] menu. Thereafter, the last menu that you used is displayed.

*1: These are only displayed when another CDA unit is connected on the left side of this CDA unit.

3-3 Thickness

In general, to perform thickness measurement, two displacement sensors are installed on each side of an object to monitor the calculated values from measurement results. Then, calculate or observe the workpiece thickness from the obtained measurement values.

You can easily switch to the measurement by setting the CDA's application setting to [Thickness] and setting the minimal parameters.

* As an example, the operation is performed with the CD22 connected. Because these are the amplifier settings, the CDX will have the same settings.

* This setting is not used with the TD1.

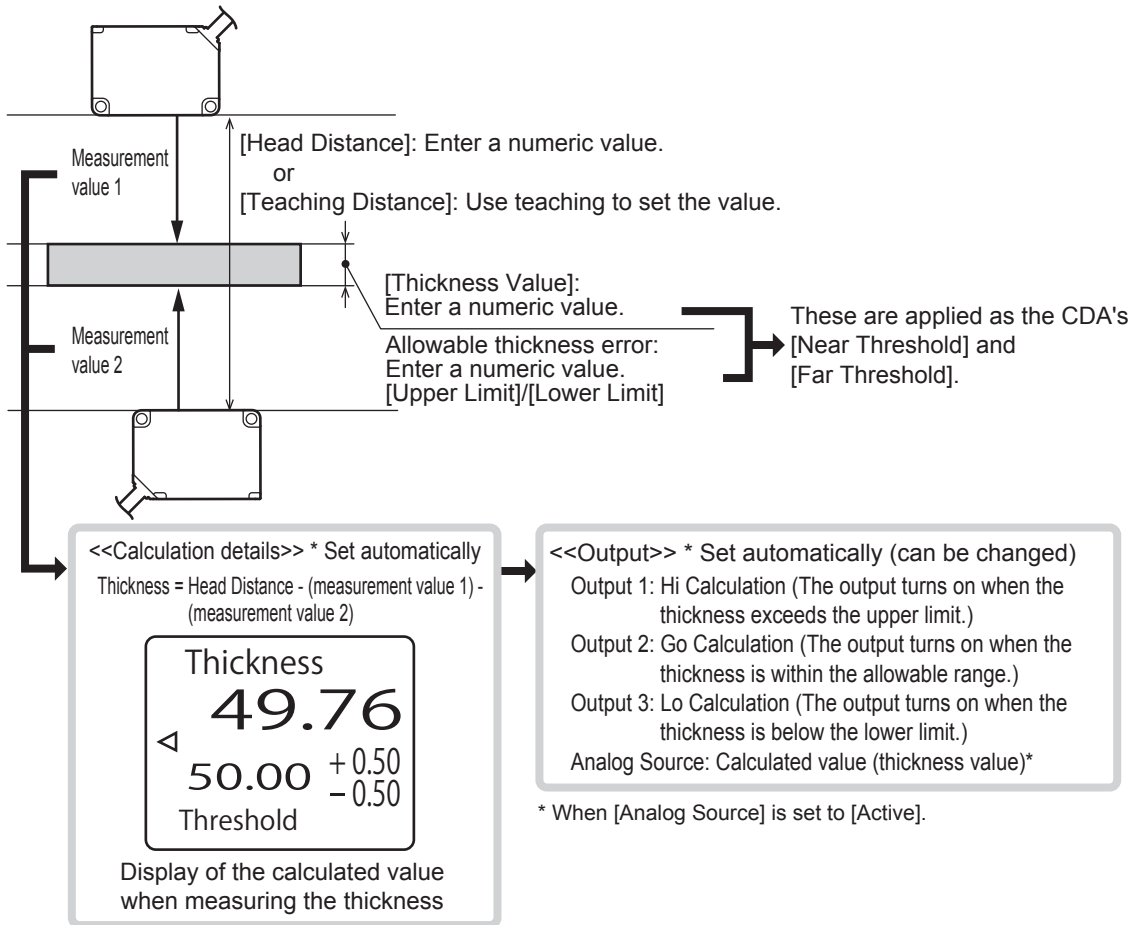

3-3-1 Thickness Measurement Procedure

You can follow the procedure shown below to perform a thickness measurement using the CDA and two displacement sensors.

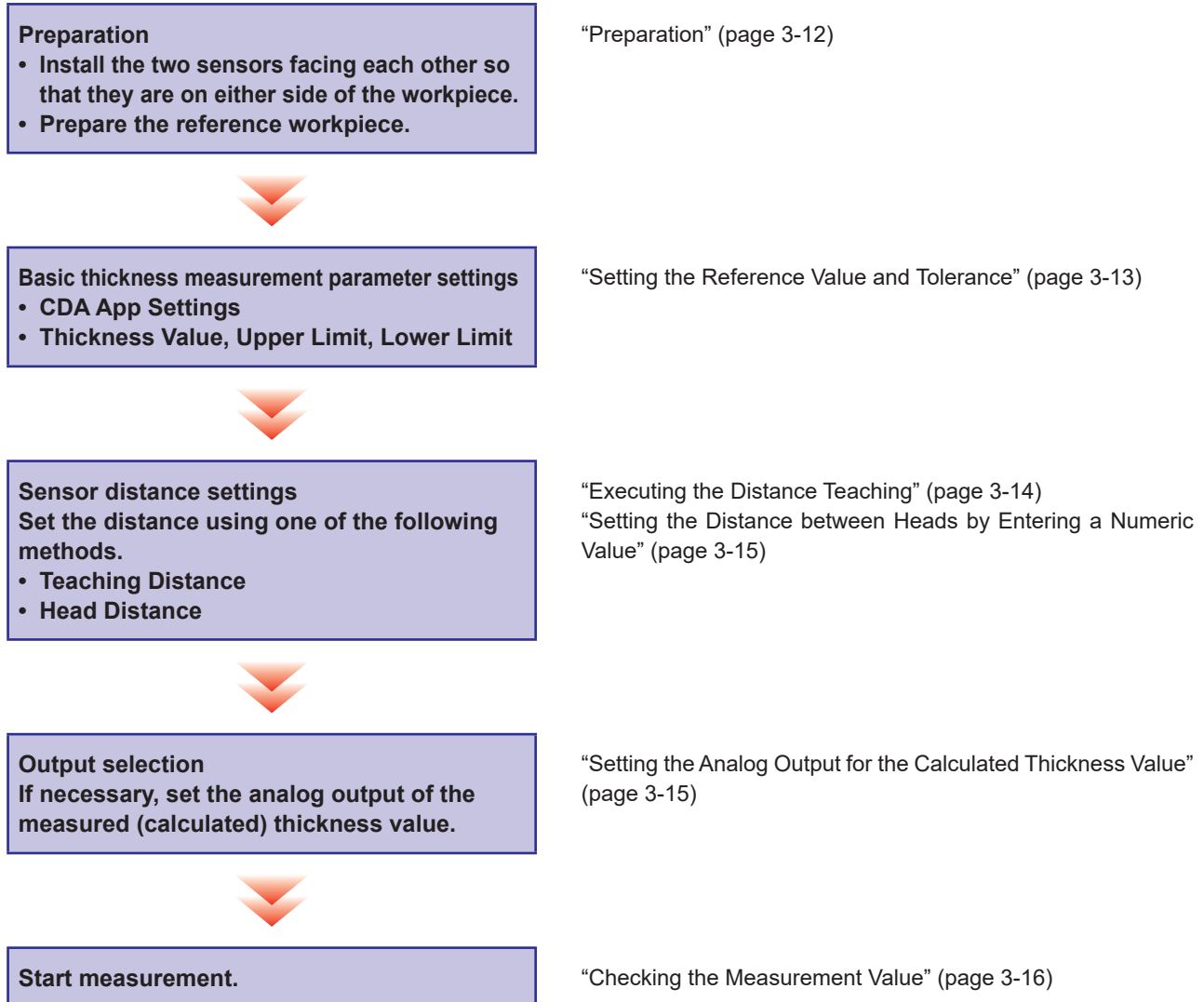

3-3-2 Preparation

- 1** To perform thickness measurement, install two CD22 units facing each other on either side of the object.
Install the sensors so that their laser light axes are perpendicular to the workpiece.
- 2** When you are setting the head distance from the actual value measured by distance teaching, prepare a workpiece that will be the reference for the thickness, and then place the workpiece in the same manner as the actual measurement.

MEMO

For a smooth transition, if there are any settings required for the sensors, apply them before moving to the amplifier settings. (See "Chapter 4 Compatible Sensor Settings.")

3-3-3 Setting the Reference Value and Tolerance

1 On the basic screen, press or to select [AMP], and then press .

The AMP Settings Top Menu is displayed.

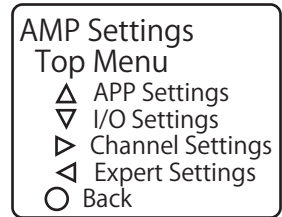

2 Press .

The display switches to the [AMP APP Settings] menu.

The [Application Sel] screen is always displayed first on this menu.

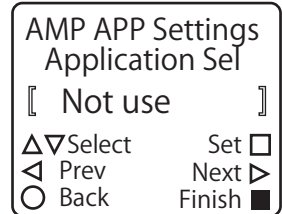

3 On the [Application Sel] screen, select [Thickness].

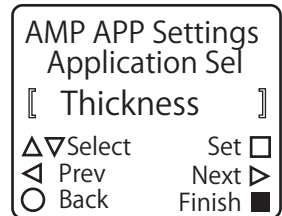

MEMO

When you set [Application Sel] to [Thickness], the calculation settings of the measurement value between the two sensors that is required for the thickness measurement and the judgment output assignment are set automatically. If you want to change the judgment output assignment, see "■ Assigning the output sources for the calculated value" (3-28).

4 Press .

The [Thickness Value] screen is displayed.

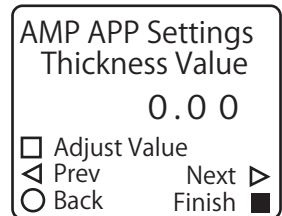

5 Enter the numeric value of the thickness that will be the judgment reference.

Thickness Value	Enter the judgment reference (the target thickness) in units of millimeters. 0.00 to 100.00
------------------------	---

* The default value is shown in bold.

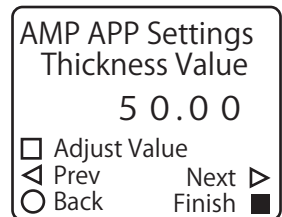

6 Press .

The [Upper Limit] screen is displayed.

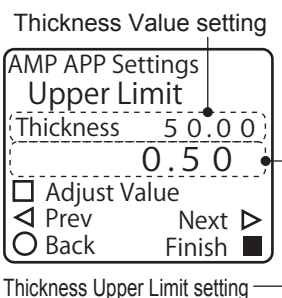

7 Enter the thickness upper limit.

Upper Limit	Enter the value to use as the upper limit of the allowable thickness. -327.68 to 0.50 or higher (327.67 - Thickness Value)
--------------------	--

* The default value is shown in bold.

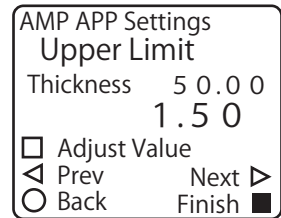

8 Press .

The [Lower Limit] screen is displayed.

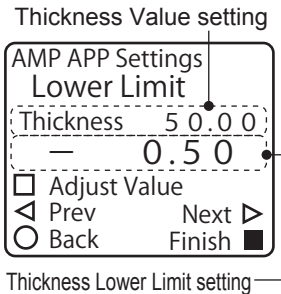

9 Set the thickness lower limit.

Lower Limit	Enter the value to use as the lower limit of the allowable thickness. 327.68 to 0.50 or higher (327.67 - Thickness Value)
--------------------	---

* The default value is shown in bold.

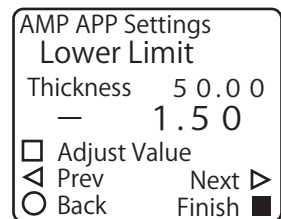

Continue by using teaching or entering the numeric value to set the distance between the two sensors that are installed facing each other.

- If you are using a workpiece as the thickness reference and are performing teaching to set the distance between the sensors, proceed to the next section.
- If you are entering the numeric value directly to set the distance between the sensors, proceed to “3-3-5 Setting the Distance between Heads by Entering a Numeric Value” (page 3-15).

3-3-4 Executing the Distance Teaching

1 When you are finished setting the [Lower Limit], press .

The [Teaching Distance] screen is displayed.

Check that the workpiece to use as the thickness reference is positioned in the same manner as for normal measurements, and then proceed to the next step.

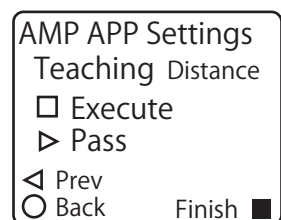

2 Press .

Distance teaching is executed from the current measurement values of the sensors, and then the display switches to the [Head Distance] screen. The distance between the sensors is calculated and is displayed as the setting value of [Head Distance].

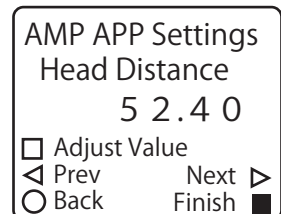

The thickness is calculated from the measurement values of the two sensors. If analog output is necessary, continue to “3-3-6 Setting the Analog Output for the Calculated Thickness Value” (page 3-15).

If analog output is not necessary, this completes the setting of the thickness measurement.

3-3-5 Setting the Distance between Heads by Entering a Numeric Value

Instead of executing teaching, you can directly enter a numeric value for the distance between the heads. You can also use this to perform corrections after executing [Teaching Distance].

MEMO

The distance between the heads that you set here is not the actual distance between the sensors. It is the value defined by the following calculation.
 Distance between heads = actual distance between sensors - center of measurement range of the channel 1 sensor - center of measurement range of the channel 2 sensor

- 1 When you are finished setting the [Lower Limit], press twice. The display switches to the [Head Distance] screen.

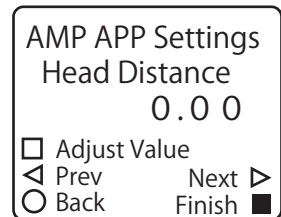

- 2 Enter the distance between the heads.

Head Distance	Enter the distance between two sensors that are installed facing each other. -100.00 to 0.00 to 100.00
----------------------	--

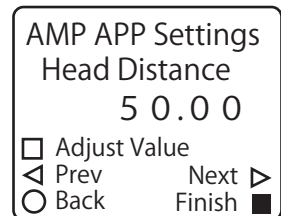

* The default value is shown in bold.

The thickness is calculated from the measurement values of the two sensors. If analog output is necessary, continue to “3-3-6 Setting the Analog Output for the Calculated Thickness Value” (page 3-15).

If analog output is not necessary, this completes the setting of the thickness measurement.

3-3-6 Setting the Analog Output for the Calculated Thickness Value

You can output not only a judgment with the reference value, but also a calculated thickness value as an analog signal.

- 1 When you complete executing [Teaching Distance] or setting the [Head Distance], press . The [Analog Source] screen is displayed.

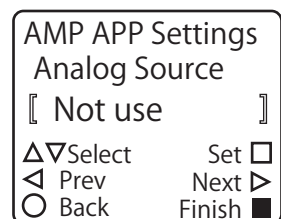

- 2 Change [Analog Source] to [Active].

Analog Source	Set the analog output assignment when [Application Sel] is set to [Thickness]. When you select [Active], the calculated thickness value is output. Not use/Active
----------------------	--

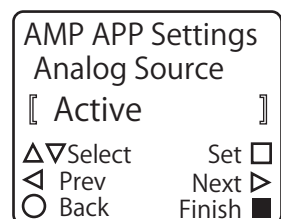

* The default value is shown in bold.

This completes the setting of the thickness measurement.

3-3-7 Checking the Measurement Value

Start the line moving, and then begin measurements.

Press \triangleright on the basic screen to switch to the [Thickness] screen.

On the display panel, you can check the calculated thickness value as well as the set thickness value, upper limit, and lower limit. You can also use the lighting of the indicators to check the judgment result.

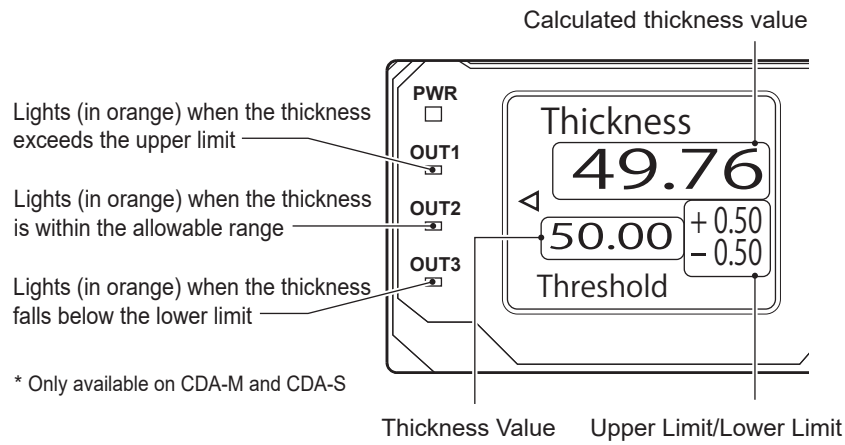

MEMO

The LED operations shown above assume that no changes were made to the default I/O settings.

3-4 Level Difference

Use two displacement sensors and calculate or observe the workpiece level difference from the difference between the obtained measurement values. You can easily switch to the measurement by setting the CDA's application setting to [Difference] and setting the minimal parameters.

* As an example, the operation is performed with the CD22 connected. Because these are the amplifier settings, the same settings can be applied with the CDX.

* This setting is not used with the TD1.

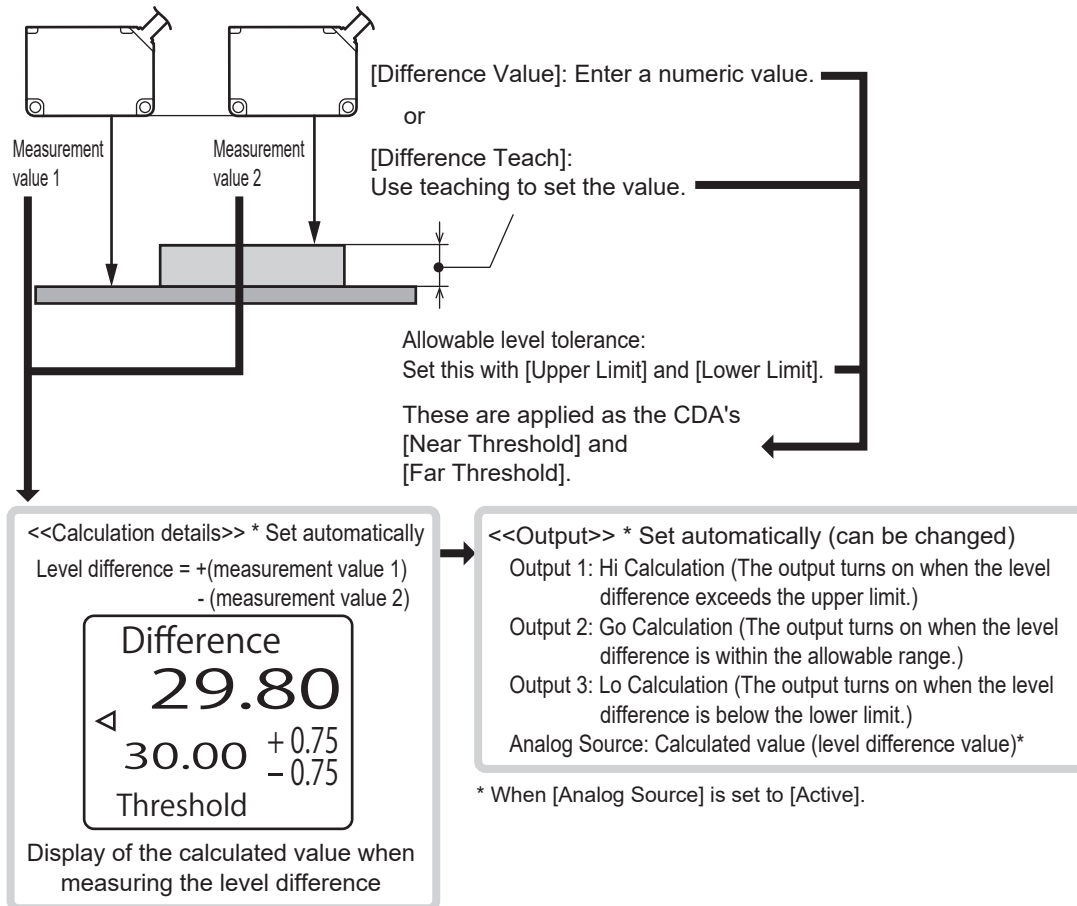

3-4-1 Level Difference Measurement Procedure

You can follow the procedure shown below to perform a level difference measurement using the CDA and two displacement sensors.

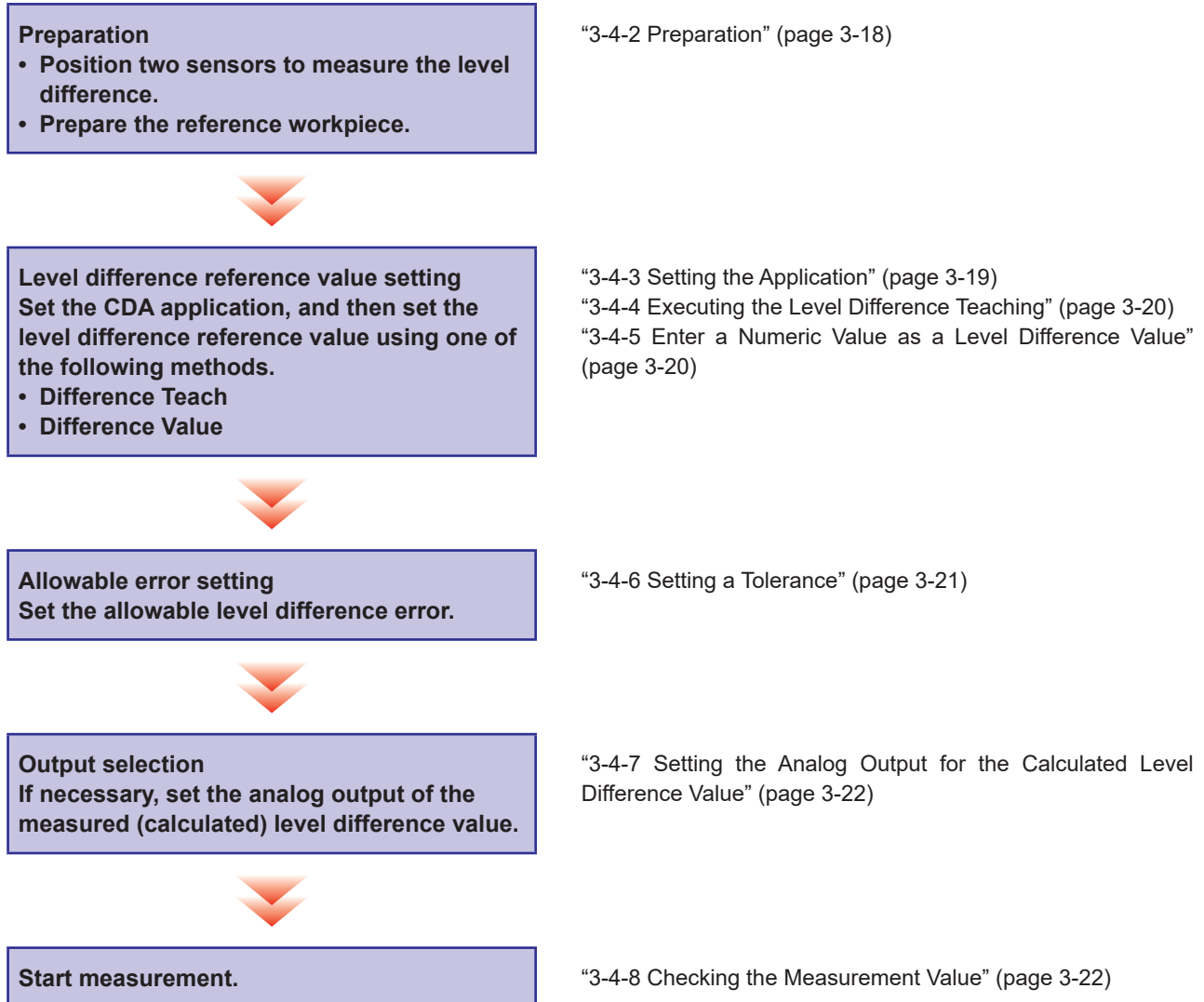

3-4-2 Preparation

- 1** Install two compatible sensors so that they can measure two locations on a workpiece that has a level difference.
- 2** When you are setting the level difference reference value from the actual value measured by level difference teaching, prepare a workpiece that will be the reference for the level difference, and then place the workpiece in the same manner as the actual measurement.

MEMO

For a smooth transition, if there are any settings required for the sensors, apply them before moving to the amplifier settings.

3-4-3 Setting the Application

- 1** On the basic screen, press  or  to select [AMP], and then press .

The AMP Settings Top Menu is displayed.

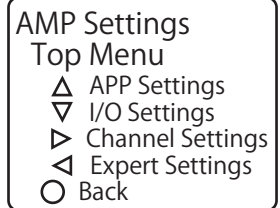

- 2** Press .

The display switches to the [AMP APP Settings] menu.

The [Application Sel] screen is always displayed first on this menu.

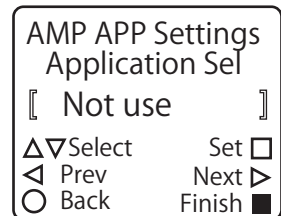

- 3** On the [Application Sel] screen, select [Difference].

Continue by setting the numeric value that will be the reference for the level difference.

- If you are using a workpiece as the level difference reference and are performing teaching to set the reference value, proceed to the next section.
- If you are entering the numeric value directly to set the level difference, proceed to "3-4-5 Enter a Numeric Value as a Level Difference Value" (page 3-20).

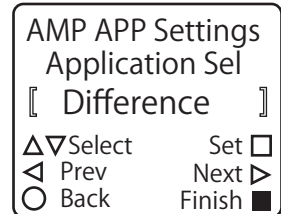

MEMO

When you set [Application Sel] to [Difference], the calculation settings of the measurement value between the two sensors that is required for the level difference measurement and the judgment output assignment are set automatically. If you want to change the judgment output assignment, see "■ Assigning the output sources for the calculated value" (3-28).

3-4-4 Executing the Level Difference Teaching

1 Set [Application Sel] to [Difference], and then press .

The [Difference Teach] screen is displayed.

Check that the workpiece to use as the level difference reference is positioned in the same manner as for normal measurements, and then proceed to the next step.

Current measurement value
for each channel

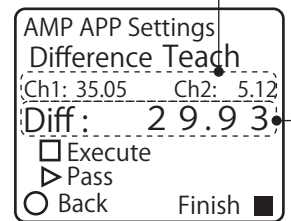

Current level difference

2 Press .

Level difference teaching is executed, and then the display switches to the [Difference Value] screen.

The level difference is calculated from the measurement values of the sensors and is displayed as the setting value of [Difference Value].

Continue by setting the allowable error from the level difference reference value. Proceed to “3-4-6 Setting a Tolerance” (page 3-21).

3-4-5 Enter a Numeric Value as a Level Difference Value

Instead of executing teaching, you can directly enter a numeric value for the level difference reference value. You can also use this to perform corrections after executing [Difference Teach].

1 Set [Application Sel] to [Difference], and then press twice.

The display switches to the [Difference Value] screen.

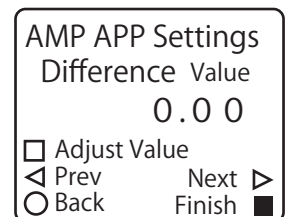

2 Enter the level difference reference value.

Difference Value	Enter the judgment reference (the target level difference) in units of millimeters. -100.00 to 0.00 to 100.00
-------------------------	---

* The default value is shown in bold.

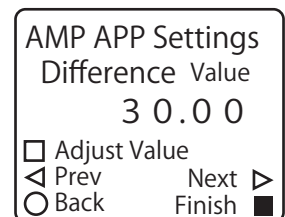

Continue by setting the allowable error from the level difference reference value.

3-4-6 Setting a Tolerance

- 1** When you complete executing [Difference Teach] or setting the [Difference Value], press .

The [Upper Limit] screen is displayed.

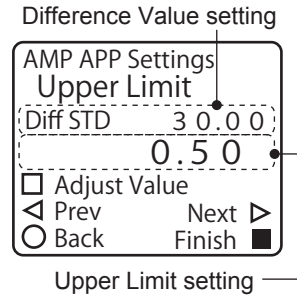

- 2** Enter the level difference upper limit.

Upper Limit	Enter the value to use as the upper limit of the allowable level difference. -327.68 to 0.50 or higher (327.67 - Difference Value)
--------------------	--

* The default value is shown in bold.

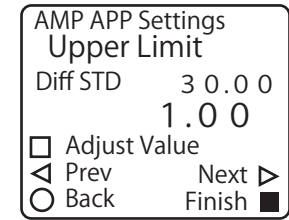

- 3** Press .

The [Lower Limit] screen is displayed.

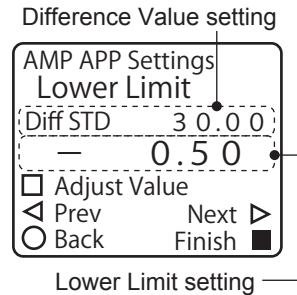

- 4** Set the level difference lower limit.

Lower Limit	Enter the value to use as the lower limit of the allowable level difference. 327.68 to -0.50 or higher (327.67 - Difference Value)
--------------------	--

* The default value is shown in bold.

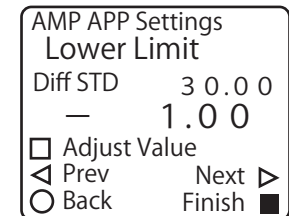

The level difference is calculated from the measurement values of the two sensors. If analog output is necessary, continue to “3-4-7 Setting the Analog Output for the Calculated Level Difference Value” (page 3-22).

If analog output is not necessary, this completes the setting of the level difference measurement.

3-4-7 Setting the Analog Output for the Calculated Level Difference Value

You can output not only a judgment with the reference value, but also a calculated thickness value as an analog signal.

- 1 When you are finished setting the [Lower Limit], press . The [Analog Source] screen is displayed.

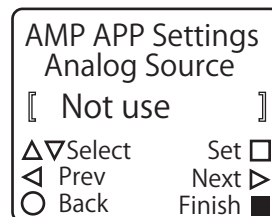

- 2 Change [Analog Source] to [Active].

Analog Source	Set the analog output assignment when [Application Sel] is set to [Difference]. When you select [Active], the calculated level difference value is output. Not use/Active
----------------------	---

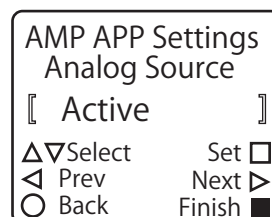

* The default value is shown in bold.

This completes the setting of the level difference measurement.

3-4-8 Checking the Measurement Value

Start the line moving, and then begin measurements.

Press on the basic screen to switch to the [Difference] screen.

On the display panel, you can check the calculated level difference value as well as the set level difference value, upper limit, and lower limit. You can also use the lighting of the indicators to check the judgment result.

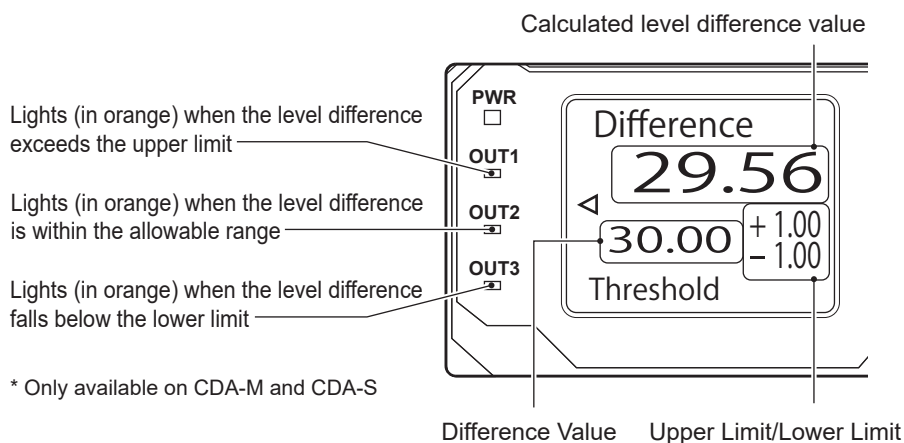

MEMO

The LED operations shown above assume that no changes were made to the default I/O settings.

3-5 Calculation Settings

Calculations are set automatically for the measurement values of each channel to correspond to the application specified with [APP Settings] under AMP Settings. You can also add calculation settings for the measurement values of each channel on the CDA.

* As an example, the operation is performed with the CD22 connected. Because these are the amplifier settings, the same settings can be applied with the CDX and TD1.

You can assign the following three types of calculation settings for each channel on the CDA.

Calculation setting	Details
Not use	The measurement value of the set channel will not be calculated. Channels for which no calculation settings have been added are not related to the calculated value.
+ Addition	The measurement value of the set channel will be added.
- Subtraction	The measurement value of the set channel will be subtracted.
- Abso Sub	The absolute value of the measurement value of the set channel will be subtracted.

Example 1: Calculated values from the various calculation settings when channel 1 = 10 and channel 2 = 15

Channel	Calculation setting
1	+ Addition
2	+ Addition
Calculated value	$(10) + (15) = 25$

Channel	Calculation setting
1	- Subtraction
2	- Subtraction
Calculated value	$-(10) - (15) = -25$

Channel	Calculation setting
1	+ Addition
2	- Subtraction
Calculated value	$(10) - (15) = -5$

Channel	Calculation setting
1	- Subtraction
2	+ Addition
Calculated value	$-(10) + (15) = 5$

Channel	Calculation setting
1	+ Addition
2	- Abso Sub
Calculated value	$(10) - (15) = -5$

Channel	Calculation setting
1	- Abso Sub
2	+ Addition
Calculated value	$-(10) + (15) = 5$

Channel	Calculation setting
1	- Subtraction
2	- Abso Sub
Calculated value	$-(10) - (15) = -25$

Channel	Calculation setting
1	- Abso Sub
2	- Subtraction
Calculated value	$-(10) - (15) = -25$

Channel	Calculation setting
1	- Abso Sub
2	- Abso Sub
Calculated value	$-(10) - (15) = -25$

Channel	Calculation setting
1	Not use
2	+ Addition
Calculated value	$+ (15) = 15$

Channel	Calculation setting
1	Not use
2	- Subtraction
Calculated value	$-(15) = -15$

Channel	Calculation setting
1	Not use
2	- Abso Sub
Calculated value	$-(15) = -15$

Example 2: Calculated values from the various calculation settings when channel 1 = -10 and channel 2 = -15

Channel	Calculation setting
1	+ Addition
2	+ Addition
Calculated value	$(-10) + (-15) = -25$

Channel	Calculation setting
1	- Subtraction
2	- Subtraction
Calculated value	$-(-10) - (-15) = 25$

Channel	Calculation setting
1	+ Addition
2	- Subtraction
Calculated value	$(-10) - (-15) = 5$

Channel	Calculation setting
1	- Subtraction
2	+ Addition
Calculated value	$-(-10) + (-15) = -5$

Channel	Calculation setting
1	+ Addition
2	- Abso Sub
Calculated value	$(-10) - (15) = -25$

Channel	Calculation setting
1	- Abso Sub
2	+ Addition
Calculated value	$-(-10) + (-15) = -25$

Channel	Calculation setting
1	- Subtraction
2	- Abso Sub
Calculated value	$-(-10) - (15) = -5$

Channel	Calculation setting
1	- Abso Sub
2	- Subtraction
Calculated value	$-(-10) - (-15) = 5$

Channel	Calculation setting
1	- Abso Sub
2	- Abso Sub
Calculated value	$-(-10) - (15) = -25$

Channel	Calculation setting
1	Not use
2	+ Addition
Calculated value	$+ (-15) = -15$

Channel	Calculation setting
1	Not use
2	- Subtraction
Calculated value	$- (-15) = 15$

Channel	Calculation setting
1	Not use
2	- Abso Sub
Calculated value	$- (15) = -15$

3-5-1 Setting the Calculation

This section explains the procedure for setting channel 1 to absolute value subtraction and channel 2 to subtraction.

- 1** On the basic screen, press Δ or ∇ to select [AMP], and then press A .

The AMP Settings Top Menu is displayed.

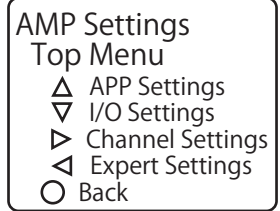

- 2** Press \leftarrow .

The display switches to the [AMP EXP Settings] menu.

- 3** Use \leftarrow or \rightarrow to switch to the [Ch1 Calculation] screen.

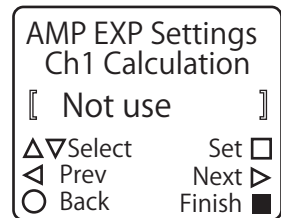

- 4** Use Δ or ∇ to select [-|| Abso Sub], and then confirm your selection with A .

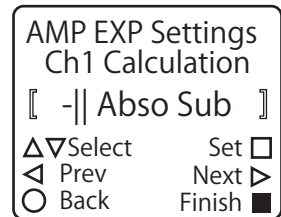

- 5** Press .
The display switches to the [Ch2 Calculation] screen.

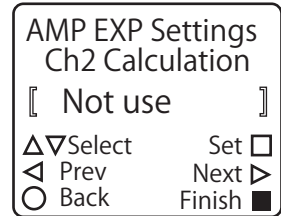

- 6** Use or to select [+ Addition], and then confirm your selection with .

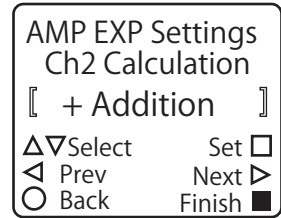

MEMO

When you set the calculation, the calculation setting added to each channel is displayed on the Calculation screen.

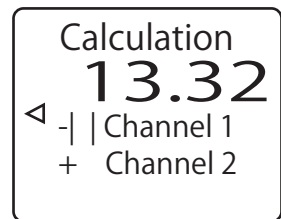

3-5-2 Setting the Calculated Value Judgment

Follow the procedure in this section to apply the calculated value judgment to the control output.

■ Setting the calculated value judgment references

Set the numeric values that are required for performing judgment on the calculated value.

- 1** On the basic screen, press or to select [AMP], and then press .
- The AMP Settings Top Menu is displayed.

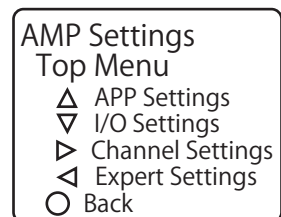

- 2** Press .
- The display switches to the [AMP EXP Settings] menu.

- 3** Use or to switch to the [Near Threshold] screen.

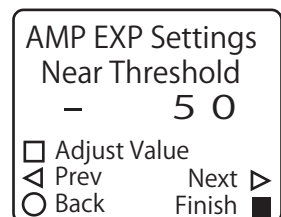

4 Change the [Near Threshold] value.

Near Threshold	Set the numeric value of the lower limit to use when performing judgment. -32768 to -50 to 32767
-----------------------	--

* The default value is shown in bold.

AMP EXP Settings
Near Threshold
- 1 0 0

Adjust Value
◀ Prev Next ▶
○ Back Finish ■

5 Press .

The display switches to the [Far Threshold] screen.

AMP EXP Settings
Far Threshold
5 0

Adjust Value
◀ Prev Next ▶
○ Back Finish ■

6 Change the [Far Threshold] value.

Far Threshold	Set the numeric value of the upper limit to use when performing judgment. -32768 to 50 to 32767
----------------------	---

* The default value is shown in bold.

Continue by assigning the output sources.

AMP EXP Settings
Far Threshold
1 0 0

Adjust Value
◀ Prev Next ▶
○ Back Finish ■

MEMO

When you are referencing calculated values over a field network, you have to assign the calculated values to channel 2 of the CDA.

On the [AMP EXP Settings] menu, change to the [Monitor Calc] screen, and then select [Calculated Val].

AMP EXP Settings
Monitor Calc
[Calculated Val]

▲▼Select Set
◀ Prev Next ▶
○ Back Finish ■

■ Assigning the output sources for the calculated value

1 Press **(B)** to return to the **AMP Settings Top Menu**, and then press **(V)**.
The display switches to the [AMP I/O Settings] menu.

2 Use **(◀)** or **(▶)** to switch to the **[OUT1 Source]**, **[OUT2 Source]**, or **[OUT3 Source]** screen.

OUT1 Source	Select the details to assign to output 1.
OUT2 Source	Select the details to assign to output 2.
OUT3 Source *1	Select the details to assign to output 3.

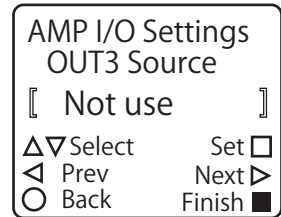

*1: Available on CDA-M and CDA-S

In this example, we have switched to the [OUT3 Source] screen.

3 **Set the calculated value's output.**

Go Calculation	Assign the calculated value's Go output. This output will turn on when the calculated value is within the range specified by Near Threshold and Far Threshold.
Hi Calculation	Assign the calculated value's Hi output. This output will turn on when the calculated value exceeds the value specified by Far Threshold.
Lo Calculation	Assign the calculated value's Lo output. This output will turn on when the calculated value falls below the value specified by Near Threshold.

Hi, Go, or Lo output can be assigned to Channel 1 and Channel 2 separately.

3-6 I/O Settings



3-6-1 Control Output Settings

This section gives an outline of the control output.

■ Control Output Setup Flow

- 1** Set the far threshold and near threshold.
- 2** Set the assignments for each control output.

■ Judgment Types

The CDA series have three control output circuits*¹ per unit.

The CDA series' calculation function has three types of judgment output—Hi, Go, and Lo—so you can assign each to the desired control output.

However, because it only has one calculation function circuit, the calculation functions are commonly used for judgment of each output.

*¹ The CDA-DM2 has two circuits.

- Hi: Output when measurement is at or above the far threshold
- Go: Output when measurement is between Hi and Lo
- Lo: Output when measurement is at or below the near threshold

■ Threshold Types

- Far Threshold: Values from 0 and toward the + side
 - Near Threshold: Values from 0 and toward the – side
- * Make sure to set a near threshold that is less than the far threshold.

■ Assigning Far Threshold and Near Threshold (Upper/Lower Limit)

The following is an example for measurement with “Measure polarity” set to “Positive,” the far threshold set to +2.500 mm, and the near threshold set to -2.500 mm.

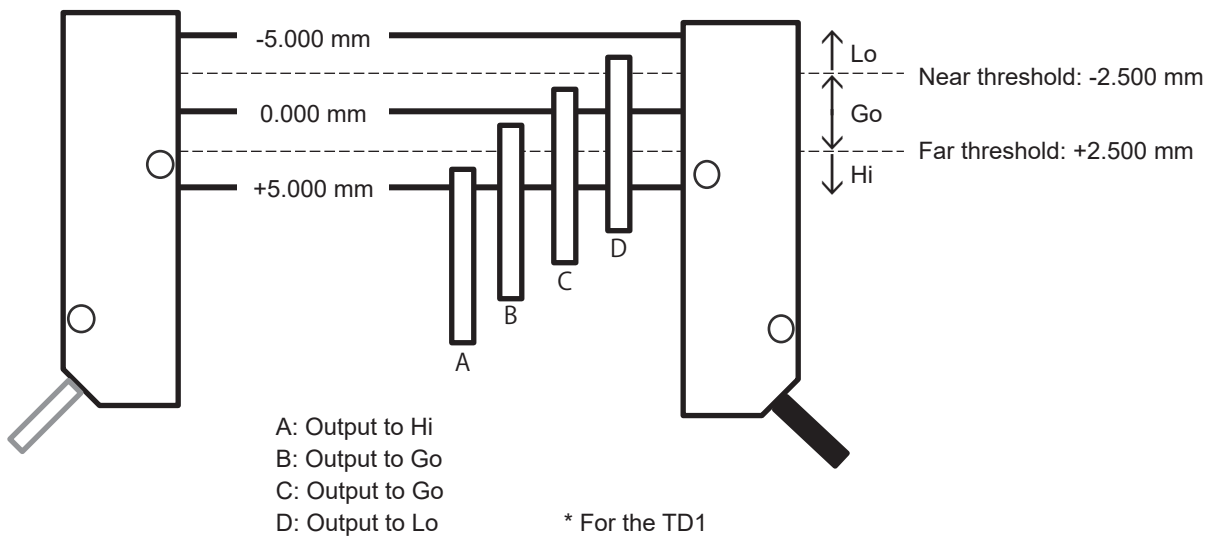

■ Assigning Control Outputs 1 to 3

To activate an output, a calculation result needs to be assigned to each of Control Outputs 1 to 3.

The following is an example based on Control Output 1 set to “Hi,” Control Output 2 set to “Go,” and Control Output 3 set to “Lo.”

- A: Control Output 1: ON, Control Output 2: OFF, Control Output 3: OFF
- B: Control Output 1: OFF, Control Output 2: ON, Control Output 3: OFF
- C: Control Output 1: OFF, Control Output 2: ON, Control Output 3: OFF
- D: Control Output 1: OFF, Control Output 2: OFF, Control Output 3: ON

* Because the CD22 and CDX have a judgment output for each channel, selecting [Independent] in [Application Sel] automatically assigns its judgment to Control Output 1 and Control Output 2.

■ Control Output Setup Procedure

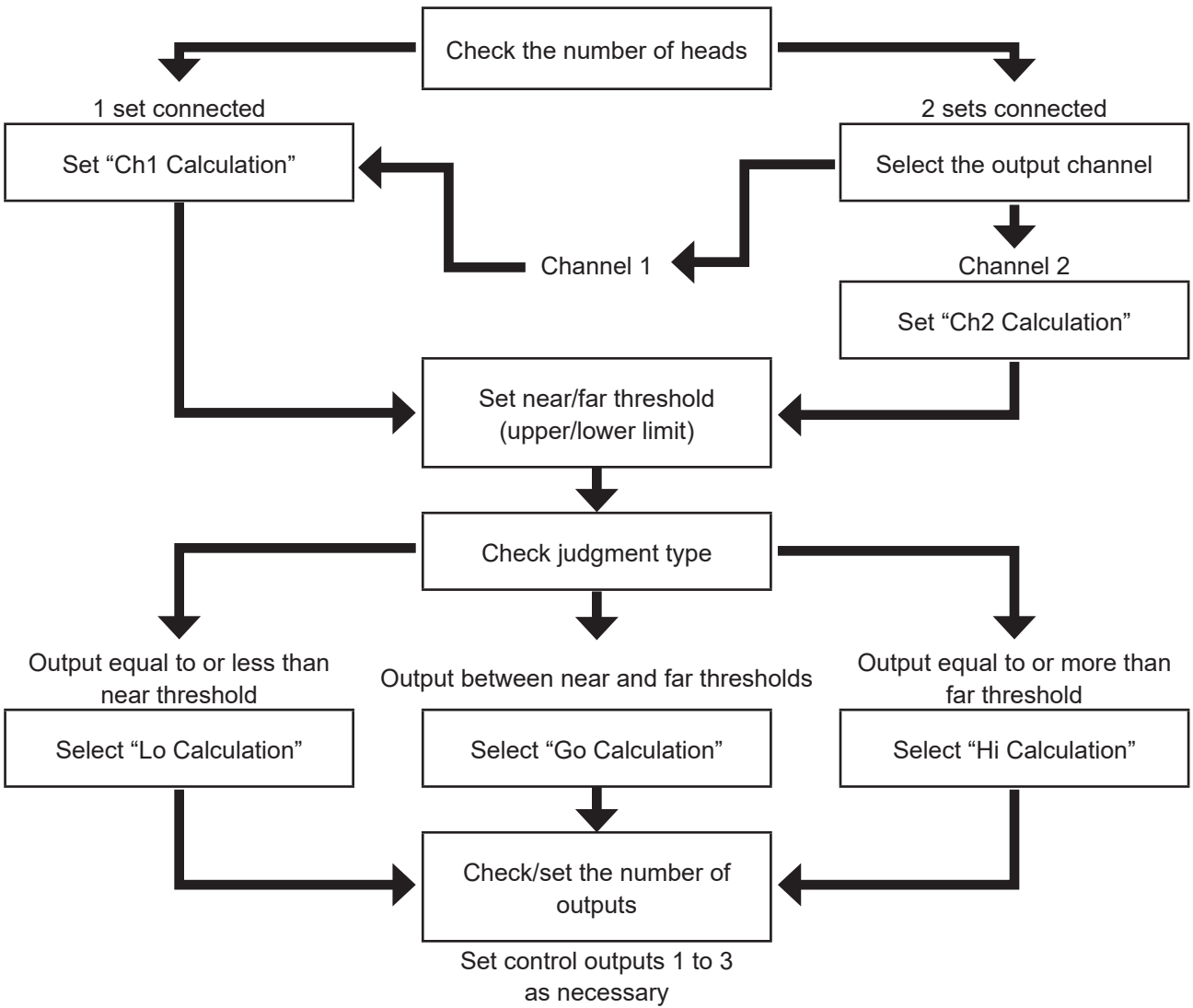

Control (Upper/Lower) Output Settings

This section explains how to set control outputs. As an example, control outputs 1 to 3 are assigned for measurement values from Channel 1.

For details on setting conditions, see “Setting example” on page 3-35.

1 Press the down button.

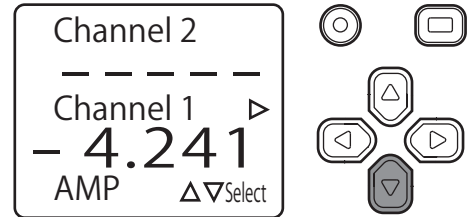

2 Press the A button while ▶ is displayed next to “AMP.”

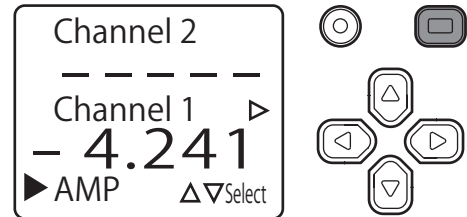

3 Press the left button.

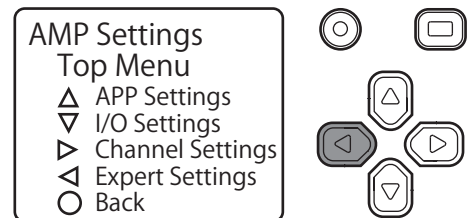

4 Press the up button.
* If “Ch1 Calculation” is not displayed, press the left or right button several times.

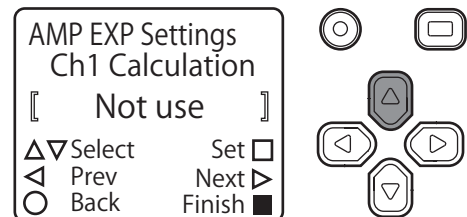

5 Press the A button with “+ Addition” displayed.

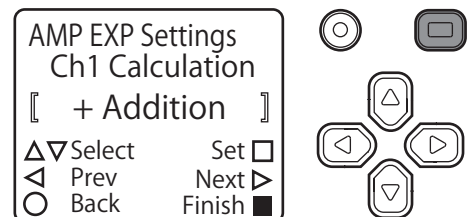

6 Press the right button twice.

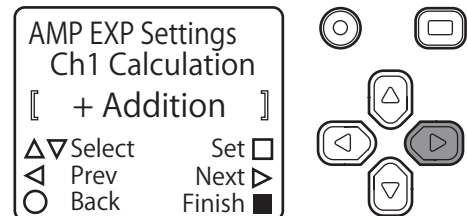

● Setting the near threshold

7 Press the A button to change the value to -1500.

* To change the value: Press the left or right button to change the number of digits. Press the up or down button to change the value.

* For details, refer to the memo on page 3-35.

8 Press the A button with “-1500” displayed.

9 Press the right button.

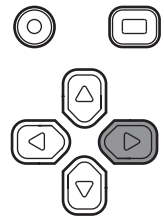
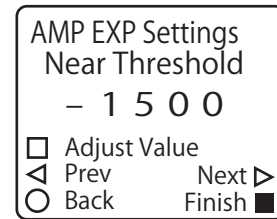
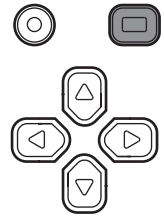
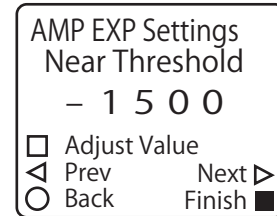
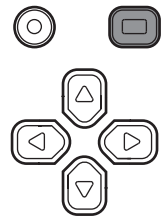
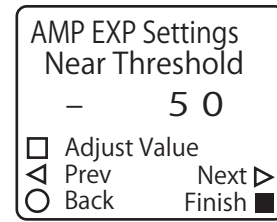

● Setting the far threshold

10 Press the A button to change the value to 1500.

* To change the value: Press the left or right button to change the number of digits. Press the up or down button to change the value.

* For details, refer to the memo on page 3-35.

11 Press the A button with “1500” displayed.

12 Press the B button.

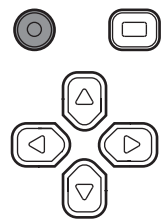
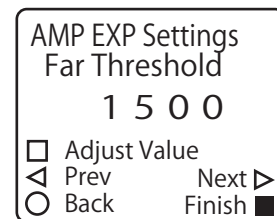
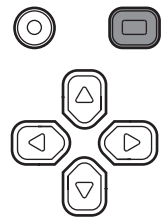
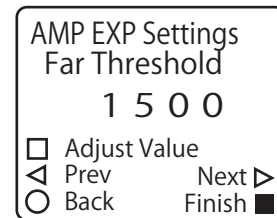
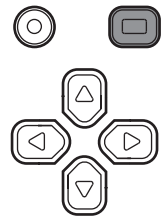
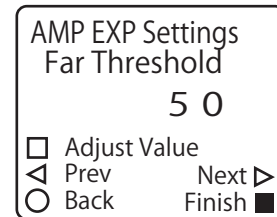

● **Setting the assignments for each control output**

Setting Control Output 1

13 Press the down button.

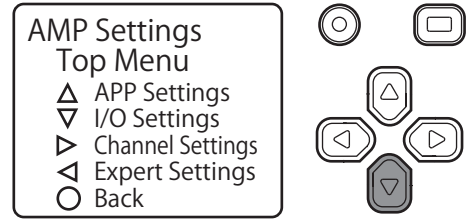

14 Press the up button with “OUT1 Source” displayed.
 * If “OUT1 Source” is not displayed, press the left or right button several times.

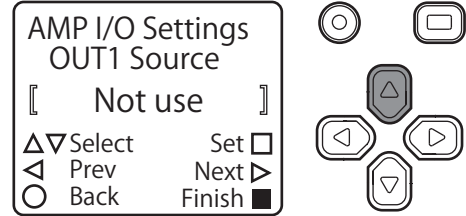

15 Press the A button with “Hi Calculation” displayed.

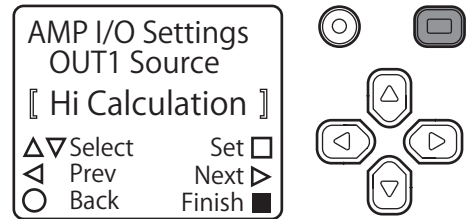

16 Press the right button.

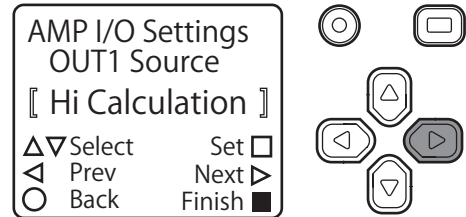

Setting Control Output 2

17 Press the A button with “Go Calculation” displayed.

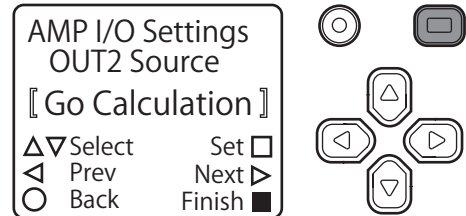

18 Press the right button.

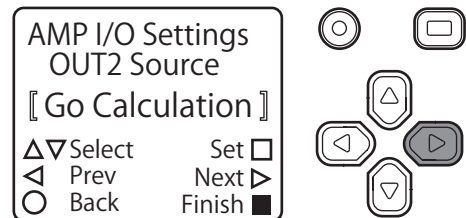

Setting Control Output 3

19 Press the A button with “Lo Calculation” displayed.

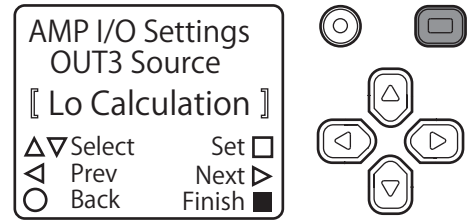

20 Press and hold the B button.

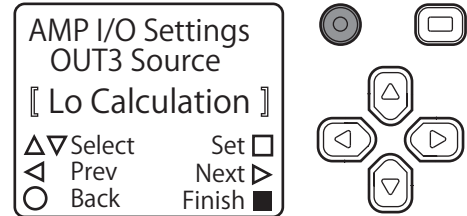

21 The display returns to the top screen (measurement value display screen), signifying that the settings have been configured.

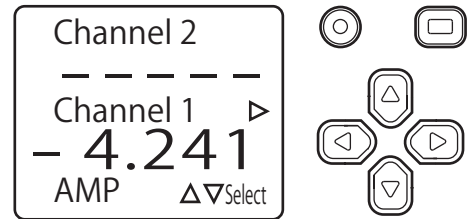

* Because the TD1 does not have judgment outputs for each channel, calculation is used to perform outputs. Output settings on the CD22 or CDX can be set on each output.

● **Setting example**

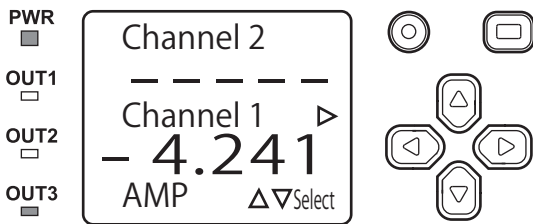

At +1.500 mm or more, Control Output 1 (OUT1) is ON. Between +1.500 mm and -1.500 mm, Control Output 2 (OUT2) is ON. At -1.500 mm or less, Control Output 3 (OUT3) is ON. When an output is ON, the indicator is illuminated. The figure on the left shows Channel 1 as 1.500 mm or less, so Control Output 3 (OUT3) turns ON.

●●● **MEMO** ●●●

• As shown in the following operation example, it may be possible to move the frame to a digit that is not displayed.

Example: Setting “Clamp holding time” to a four-digit numeric value

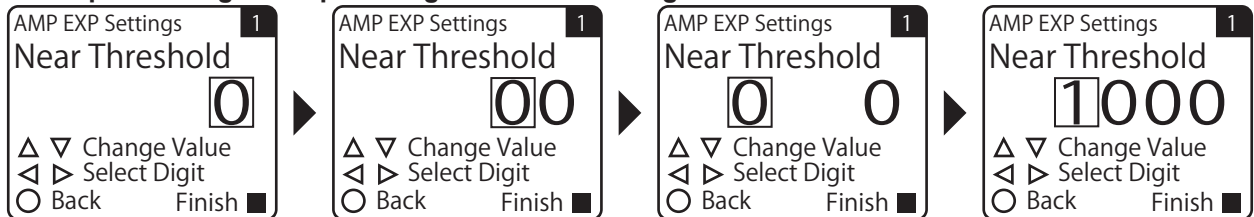

As shown in the above figure, this item's default value is “0.”

Press the left button once to move to the digit on the left and display a “0.”

Press the left button twice more to move to the thousands position. The digits between the ones position and the thousands position are not displayed.

Pressing the up button to change the thousands position value to something other than “0.” will cause the intervening digits to be displayed as “0.”

Up button: Increases the numeric value.
Down button: Decreases the numeric value.

Press the down button with “0000” displayed to show “-”.

• Pressing the B button before pressing the A button to confirm the value change will cancel the change and return to the setting screen.

3-6-2 Analog Output Settings

This section explains how to set analog output.

■ Configuring Analog Output Settings

1 Select "AMP."

Press the down button to select "AMP," and then press the A button.

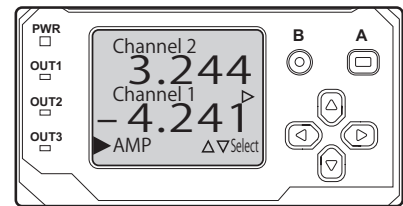

2 Select "I/O Settings."

Press the down button.

Selecting the output type (voltage 0 to 10 V, current 4 to 20 mA)*1

Select [Analog1 Type] using the right button.

Select the output type with the up and down buttons.

*1 The output type can only be switched with the CDA-DM2.

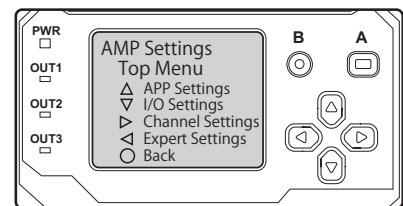

Analog1 Type

4 to 20 mA output*
0 to 10 V output
Not use

3 Select [Analog1 Type]* using the left and right buttons.

* This is a CDA-DM2 item. For analog 2, this will be [Analog2 Source]. For the CDA-M, this will be [Analog Source].

4 Select the output target.

For the CDA-DM2

Because there are two analog outputs, an output target is selected for each.

If assigning to analog 1, assign the following items to [Analog1 Source].

* For analog 2, assign them to [Analog2 Source].

■ CDA-DM2 items

- With "Channel 1" selected:
The channel 1 value will be assigned to the set analog output (analog 1 or analog 2).
- With "Channel 2" selected:
The channel 2 value will be assigned to the set analog output (analog 1 or analog 2).
- With "Calculation" selected:
The calculated value will be assigned to the set analog output (analog 1 or analog 2).

Analog1 Source

Channel 1
Channel 2
Calculated Val

* is the default value of each setting item.

Analog Source

Not use*
Calculation
Channel 1
Channel 2

* is the default value of each setting item.

For the CDA-M

There is only one analog output.

Assign the following items to [Analog Source].

■ CDA-M items

- With "Channel 2" selected:
The measurement value for channel 2 will be assigned to analog output.
- With "Channel 1" selected:
The measurement value for channel 1 will be assigned to analog output.
- With "Calculation" selected:
The calculated value will be assigned to analog output.

Press the A button with the selected output target displayed.

■ Analog output setting example

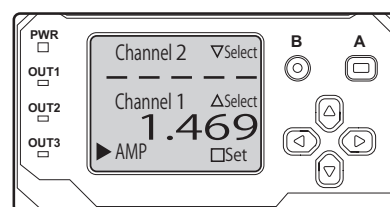

*The following is an example in which analog 1 (Analog1 Source) is changed to voltage output and output target is set to the channel 1 measurement value in CDA-DM2.

- 1 On the measurement screen, press , move  to [AMP], and press .



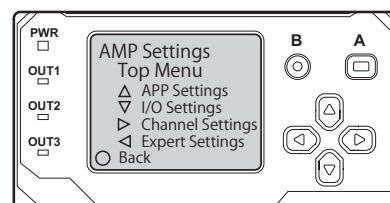

- 2 On the AMP Settings menu screen, press  and move to the I/O Settings screen.

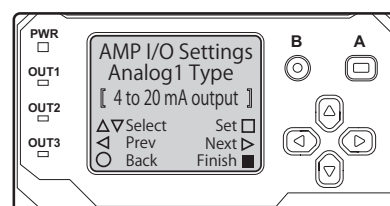

- 3 Display the Analog1 Type screen (compatible with the white analog output wire) with the   buttons.



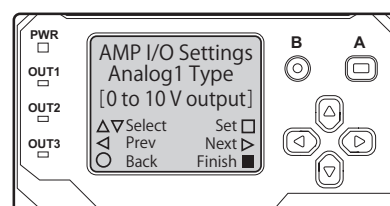

- 4 Use the   buttons to display the output method from among current (4 to 20 mA), voltage (0 to 10 V), and [Not use], and confirm with .

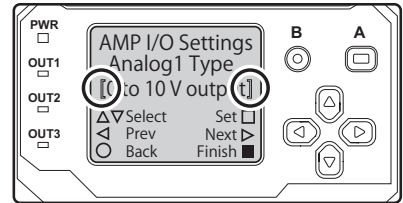

5 Once confirmed, it will be enclosed between [] brackets. After that, switch to Analog1 Source with .



6 Use the   buttons to display the output targets from Channel 1, Channel 2, and the calculated value, and confirm with .

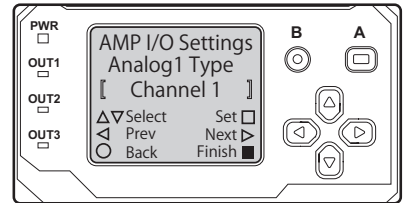

In the above example, we configured settings for analog 1. With analog 2, the only change is that the amplifier display changes from analog 1 to analog 2, and the operating method does not change.

With the CDA-M, select the output target in [Analog Source]. The output type cannot be changed.

*For the wiring of analog 1 and analog 2, see the connection diagram.

■ Analog Scaling Settings

The CDA series can output an actual value measured by a sensor as analog current or voltage. Arbitrary scaling can be set for the outputs of analog current and voltage.

* Switching of analog current and voltage output is only done with the CDA-DM2.

The following explains the setting configuration for CDA-M.

1 Verify that any setting other than “Not use” is selected for “Analog Source.”

For the setting method, see "3-6-2 Analog Output Settings" (page 3-36).

2 Select “Amplifier.”

Press the down button to select “AMP,” and then press the A button.

3 Select “I/O Settings.”

Press the down button.

4 Use the left or right button to select “Analog Scaling.”

5 Change “Analog Scaling” to “Active.”

Press the up button to select “Active,” and then press the A button.

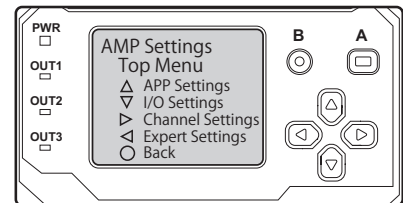
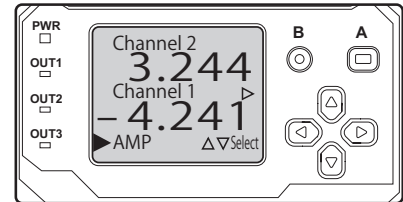

Analog Scaling

Active
Not use

● Analog scaling maximum setting

6 Use the left or right button to select “Scaling Max.”

Press the A button to change the maximum analog scaling value.

* For information on changing the values, refer to the memo on page 3-35.

5000
32768 to -32767

● Analog scaling minimum setting

7 Use the left or right button to select “Scaling Min.”

Press the A button to change the minimum analog scaling value.

* For information on changing the values, refer to the memo on page 3-35.

- 5000
32768 to -32767

■ Analog scaling setting example

*The following is an example in which the analog scaling value of analog 1 (Analog1 Source) is set to ± 3 mm in CDA-DM2.

- 1 On the measurement screen, press ∇ , move \blacktriangleright to [AMP], and press A .

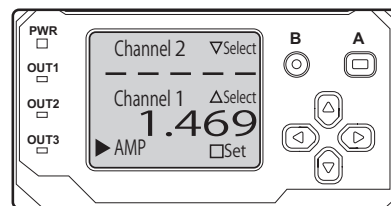

- 2 On the AMP Settings Top Menu screen, press ∇ and move to the I/O Settings screen.

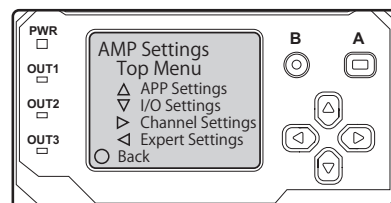

- 3 Display Scaling Max1 with \triangleleft and \triangleleft . (The Scaling Max corresponds to 20 mA for current and 10 V for voltage.)

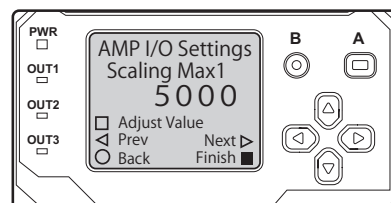

- 4 After selecting [Adjust Value] with A , use the \triangleup ∇ arrow keys to change the value, use \triangleleft \triangleright to change the digit, and use A to confirm.

* The input unit is the micrometer (μm).

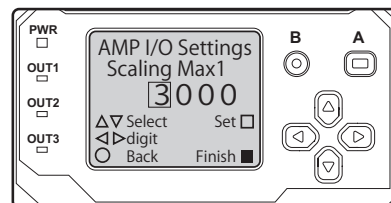



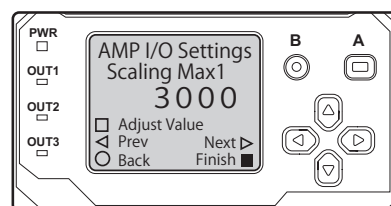

- 5 After confirming, switch to Scaling Min with \triangleleft . (The Scaling Min corresponds to 4 mA for current and 0 V for voltage.)

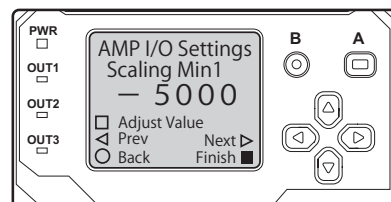

- 6 Select [Adjust Value] with A .



- 7** Use the   arrow keys to change the value, use   to change the digit, and use  to confirm.

* The input unit is the micrometer (μm).

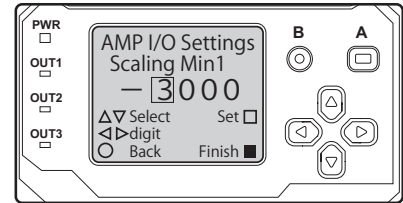

For analog 2 (Analog2 Source) settings, change the Scaling Max2 and Scaling Min2 values. With the CDA-M, change the Scaling Max and Scaling Min values of [Analog Source].

■ Analog Output Specifications

Analog output and scaling when using a CDA series product are as follows. Note that the output type varies depending on the model.

CDA-M: Analog current output of 4 to 20 mA

CDA-DM2: Analog voltage output 0 to 10 V, analog current output 4 to 20 mA: 2 outputs

Maximum and Minimum scaling values can be set between +32767 and -32768.

An example of the Scaling Max. at 5000 and the Scaling Min. at -5000 on CDA-DM2:

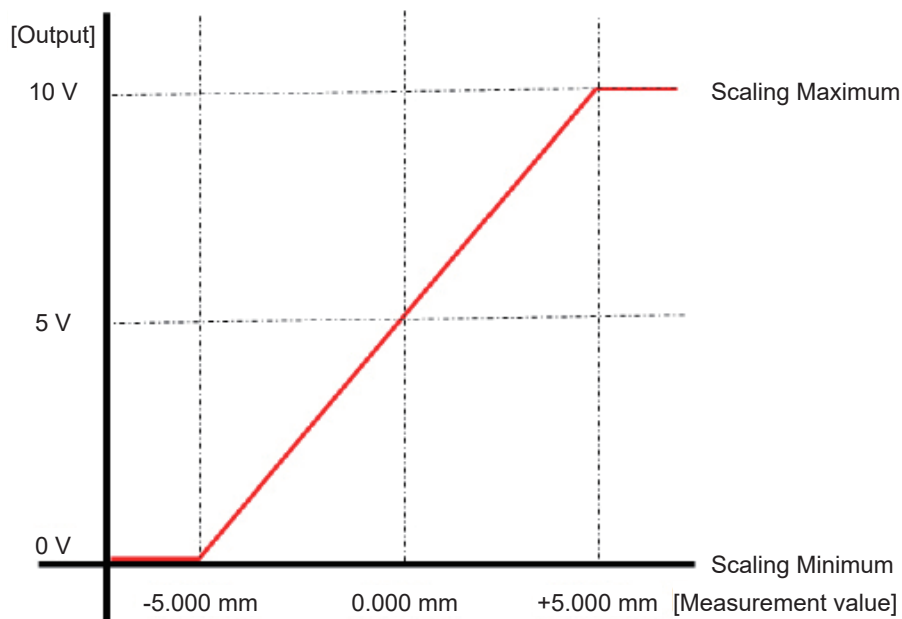

3-6-3 External Input Settings

This section explains the method of setting the external input.

External input setting method

1 Select [AMP].

Use the down button to select [AMP] and press the A button.

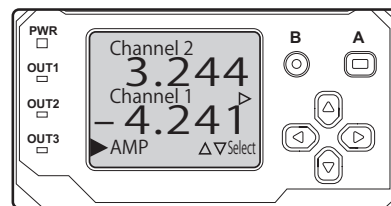

2 Select the I/O settings.

Press the down button.

3 Select [EXTIN Select] with the left or right button.

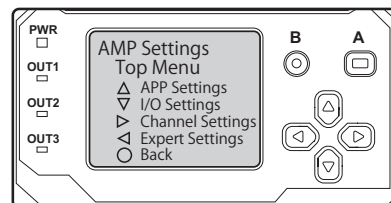

4 Select the item to assign to external input.

Item

- With "Not use" selected:
The external input will not be used.
- With "Teach mode" selected:
Teaching is performed during external input.
- With "BGS/FGS Teach" selected:
BGS/FGS teaching is performed during external input.
- With "Offset Set" selected:
The offset is executed during external input.
- With "Laser OFF" selected:
During external input, the laser stops.

EXTIN Select

Not use*
Teach mode
BGS/FGS Teach
Offset Set
Laser OFF

* is the default value of each setting item.

3-7 Channel Settings

Set the baud rate for each channel.

3-7-1 Baud Rate Settings

Baud rate settings

"Baud rate" refers to the communication speed between the CDA and the sensor.

Select the channel to configure baud rate settings.

Select the lower menu for channel 1 or the upper menu for channel 2.

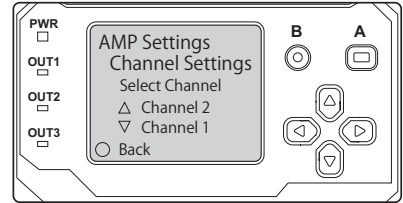

Baud rate selection

The baud rate can be selected from the following.

Not use/9.6 kbps/19.2 kbps/38.4 kbps/57.6 kbps/115.2 kbps/

230.4 kbps/312.4 kbps/468.8 kbps/500.0 kbps/625.0 kbps/

833.3 kbps/937.5 kbps/1250 kbps

*The default is 625.0 kbps.

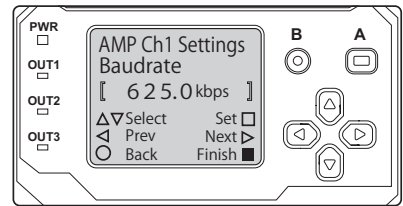

The item is changed with the up or down button. Confirm with button.

*Select "Not use" for unused channels.

For details, see "3-7-2 Setting Channel 2 to Not Be Used" (page 3-44)

3-7-2 Setting Channel 2 to Not Be Used

When Channel 2 will not be used, it can be set to not receive a signal. Configuring this setting will cancel signal communication errors for Channel 2. Canceling such errors will change the PWR indicator from red to green.

■ Checking the PWR Indicator

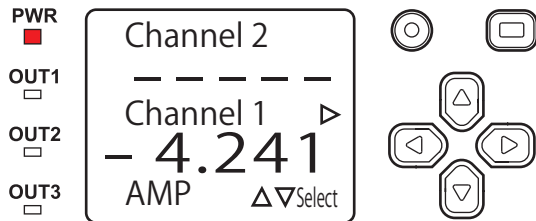

If the PWR indicator is lit in red, there is a signal communication error with Channel 2.

See "3-7-2 Setting Channel 2 to Not Be Used" (page 3-44) and configure the settings to prevent reception of the channel 2 signal.

■ Setting Channel 2 to Not Be Used

From the top screen, press the down button with ► displayed next to "AMP", and then press the A button.
→ Press the right button to select "Channel Settings", and then press the up button to display "Channel 2".
→ Press the up or down button several times to display "No Head", and then press the A button to enter.

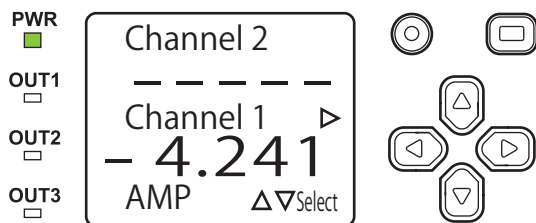

Configuration of the settings is complete if the PWR indicator turns green.

* Reset the settings when using Channel 2.

3-8 Other Settings

3-8-1 Setting the I/O Polarity

Follow the procedure shown below to set the CDA I/O polarity. You can select from four types of output made of combinations of NPN/PNP and N.O. (normally open)/N.C. (normally closed).

1 On the basic screen, press  or  to select **[AMP]**, and then press .

The AMP Settings Top Menu is displayed.

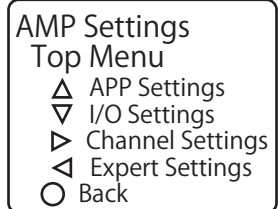

2 Press .

The [I/O Settings] menu is displayed.

3 Use  or  to switch to the [I/O Polarity] screen.

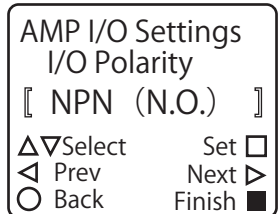



4 Select the target I/O polarity.

I/O Polarity	Set the I/O polarity. NPN (N.O.) /PNP (N.C.)/NPN (N.C.)/PNP (N.O.)
---------------------	--

* The default value is shown in bold.

3-8-2 Changing the Display Language

You can select [Japanese] or [English] for the CDA's display language.

- 1 On the basic screen, press  or  to select [AMP], and then press .

The AMP Settings Top Menu is displayed.

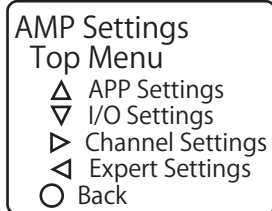

- 2 Press .

The display switches to the [AMP EXP Settings] menu.

- 3 Use  or  to switch to the [Language] screen.

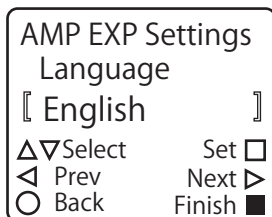

- 4 Change the display language.

Language	Select the display language. [Japanese]/[English] * When you switch the display language to Japanese [日本語表示]/[英語表示]
-----------------	--

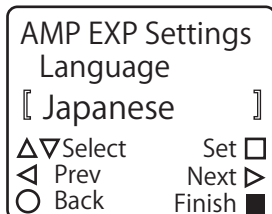

MEMO

If you set the language to [Japanese] and press  to confirm your entry, the display will switch to Japanese. To return the language to English, select [英語表示] on the screen shown in the figure on the right.

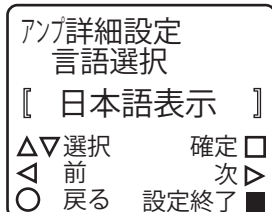

3-8-3 Initialization Settings

Follow the procedure shown below to initialize the CDA settings. When you perform this operation, all setting details except for [Language] will return to the default values.

MEMO

There is no message or other confirmation when you execute the initialization. Exercise caution when initializing the settings.

- 1 On the basic screen, press Δ or ∇ to select [AMP], and then press A .

The AMP Settings Top Menu is displayed.

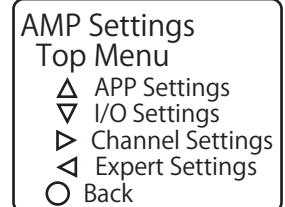

- 2 Press \triangleleft .

The display switches to the [AMP EXP Settings] menu.

- 3 Use \triangleleft or \triangleright to switch to the [Reset Settings] screen.

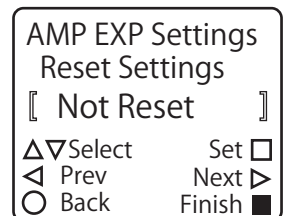

- 4 Use Δ or ∇ to display [Execute by \square].

To initialize the settings, press A while [Execute by \square] is displayed. Press B to cancel the initialization and return to the AMP Settings Top Menu.

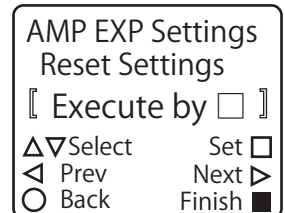

MEMO

When you execute the initialization, [Finished] is displayed on the screen as shown in the figure on the right.

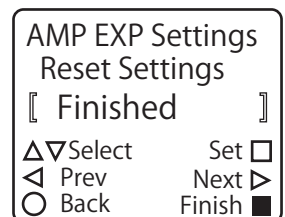

3-8-4 Correction Value Settings

You can offset the sensor's measurement values by setting correction values on the amplifier side. Also, the measurement values of a displacement sensor are normally positive or negative values from the measurement center, but you can also change the reference distance used in actual measurement on the amplifier side.

■ Changing the reference distance



Use the correction parameter A to change the way that the sensor's center of measurement range (the reference distance) is displayed.

With a displacement sensor, the center of measurement range is normally set as 0 and the measurement value is displayed as a positive or negative value. Setting the reference distance of the connected sensor to A will display the distance from the sensor to an object on the CDA unit.

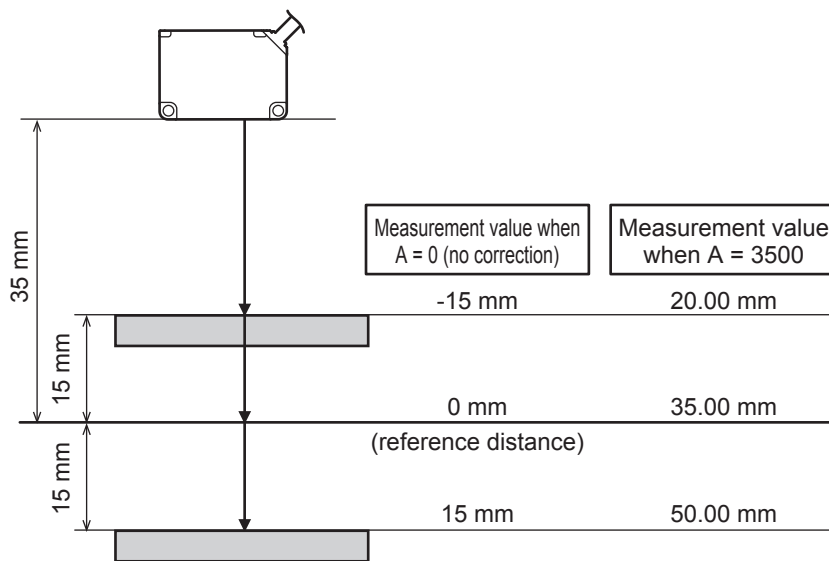
● Example: CD22-35



In this section, we will explain the setup procedure for displaying the CD22-35 measurement value as the actual distance from the sensor to the workpiece as an example.

- 1** On the basic screen, press  or  to select [AMP], and then press .

The AMP Settings Top Menu is displayed.

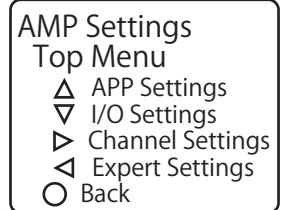

- 2** Press .

The [Channel Setting] screen is displayed.

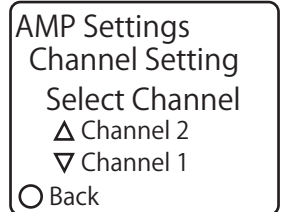

- 3** Press  or  to select the channel to correct.

Here, we will press  to select channel 1.

The display switches to the [AMP Ch1 Settings] menu.

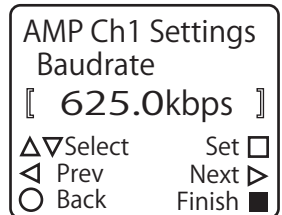

- 4** Use  or  to switch to the [Correction] screen.

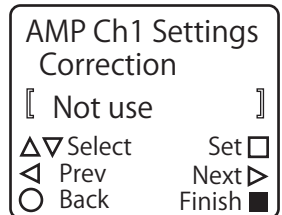

- 5** Change [Correction] to [APPLY].

Correction	Set whether to correct the input from the sensor. This can be set separately for each channel. Not use/APPLY
-------------------	---

* The default value is shown in bold.

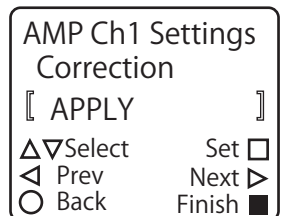

- 6** Press  to switch to the [A1: M1 (A1 + Ch1)/D1] screen.

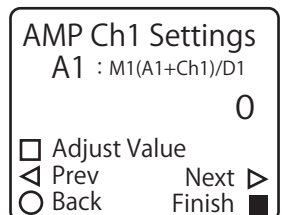

7 Set "3500" as the A1 value.

A1	Set A1 (correction parameter A for channel 1). -10000 to 0 to 10000
----	---

* The default value is shown in bold.

The channel 1 output is corrected according to the set A1 value.

AMP Ch1 Settings
A1 : M1(A1+Ch1)/D1
3 5 0 0

Adjust Value
◀ Prev Next ▶
○ Cancel Finish ■

MEMO

- Correction parameters are only displayed and can only be changed when you set [Correction] to [APPLY].
- If you set [Correction] to [Not use] after setting correction parameters, the correction will no longer be applied. However, the set correction parameter values will be retained.

Aligning the measurement range between channels

Calculation of measured data from CD22-15 and CD22-35/CD22-100 requires correction by division by 10 of the measured value one from CD22-15 to match the decimal points of the 2 sensors. In this case, the Dn parameter can be set to adjust the decimal position. This section explains about correction with a CD22-15 unit connected to Channel 1 and a CD22-35 unit to Channel 2.

1 On the basic screen, press or to select [AMP], and then press .

The AMP Settings Top Menu is displayed.

AMP Settings
Top Menu

△ APP Settings
▽ I/O Settings
▶ Channel Settings
◀ Expert Settings
○ Back

2 Press .

The [Channel Setting] screen is displayed.

AMP Settings
Channel Setting
Select Channel

△ Channel 2
▽ Channel 1
○ Back

3 Press to select [Channel 1].

The display switches to the [AMP Ch1 Settings] menu.

AMP Ch1 Settings
Baudrate
[625.0kbps]

△▽Select Set
◀ Prev Next ▶
○ Back Finish ■

4 Use or to switch to the [Correction] screen.

AMP Ch1 Settings
Correction
[Not use]

△▽Select Set
◀ Prev Next ▶
○ Back Finish ■

5 Change [Correction] to [APPLY].

Correction	Select whether to correct the output value from the amplifier. This can be set separately for each channel. Not use/APPLY
-------------------	--

* The default value is shown in bold.

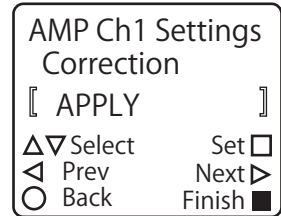

6 Press \triangleleft three times to switch to the [D1: M1 (A1 + Ch1)/D1] screen.

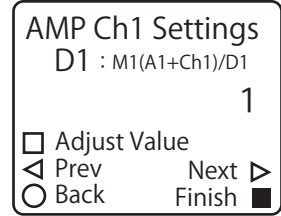

7 Set "10" as the D1 value.

D1	Set D1 (correction parameter D for channel 1). 1 to 32767
-----------	---

* The default value is shown in bold.

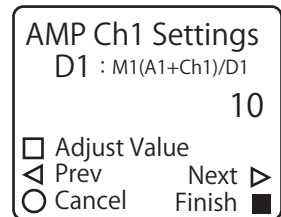

The channel 1 output is corrected according to the set D1 value.

MEMO

- You can perform correction in the same manner by pressing \triangleleft in step 3 to select [Channel 2], enabling the channel 2 correction settings, and then setting the M2 value to "10."
- Correction parameters are only displayed and can only be changed when you set [Correction] to [APPLY].
- If you set [Correction] to [Not use] after setting correction parameters, the correction will no longer be applied. However, the set correction parameter values will be retained.

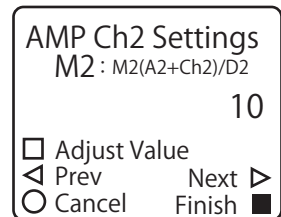



4

Compatible Sensor Settings

This chapter explains how to configure the settings of the compatible sensor, such as using teaching, from the CDA.

CD22 settings

- Setting items and menu screen transitions
- Teaching
- Alarm Settings for Measurement Error (when measurement is not possible)
- Correcting the influence of sensor light axis tilt

TD1 settings

- Setting items and menu screen transitions
- Measurement type settings
- Measurement polarity settings
- Teaching

CDX settings

- Setting items and menu screen transitions
- Analog output settings
- Analog scaling settings

4-1 CD22 Settings

MEMO

The CDA only supports the CD22 series model that supports RS-485 communication.

4-1-1 Setting Items and Screen Transitions

■ Setup mode

● Setting items

Screen name	Explanation and settable values/options	
Teaching Mode	Set the CD22's teaching method. 2-Point/FGS2/1-Point	
Near Threshold	Check or change the currently set threshold on the near side for 2-point teaching.	
	CD22-15	-7.499 to -1.000 to 7.499
	CD22-35	-22.49 to -3.00 to 22.49
Far Threshold	Check or change the currently set threshold on the far side for 2-point teaching.	
	CD22-15	-7.499 to 1.000 to 7.499
	CD22-35	-22.49 to 3.00 to 22.49
FGS2 Distance	Check or change the currently set FGS2 reference distance.	
	CD22-15	-7.499 to 0.000 to 7.499
	CD22-35	-22.49 to 0.00 to 22.49
Tolerance FGS2	Check or change the currently set FGS2 operation distance.	
	CD22-15	0.000 to 1.000 to 7.499
	CD22-35	0.00 to 3.00 to 22.49
1-Point switching	Check or change the currently set 1-point teaching threshold.	
	CD22-15	-7.499 to -1.000 to 7.499
	CD22-35	-22.49 to -3.00 to 22.49
Sampling Rate	Check or change the currently set 1-point teaching threshold.	
	CD22-100	-74.99 to -10.00 to 74.99
	Set the measurement period. Setting a large sampling rate makes the response speed slower but makes it possible to detect workpieces with poor reflectance such as black workpieces. 500/1000/2000/4000 (μs)/Auto	
Switching behavior	Select whether to generate output when light is received or when light is not received. Light-ON/Dark-ON	

Screen name	Explanation and settable values/options	
Moving averaging	Select the number of times to average the sampled measurement values. Increasing the averaging count improves the detection accuracy but makes the response slower. 1/8/ 64 /512	
Unmeasure behavior	Set the operation to perform when measurement is not possible. Clamp/Hold	
Clamp holding time	Set the number of samples over which to maintain the previous measurement value when measurement is not possible. 0 to 9999	
Key lock active	Set the behavior of the CD22 display when CD22 key operations are disabled. Display on/Display off	
Near End distance	Check or change the near-end distance correction value used when correcting the tilt of the sensor's light axis.	
	CD22-15	-7.499 to -5.000 to 7.499
	CD22-35	-22.49 to -15.00 to 22.49
	CD22-100	-74.99 to -50.00 to 74.99
Far End distance	Check or change the far-end distance correction value used when correcting the tilt of the sensor's light axis.	
	CD22-15	-7.499 to 5.000 to 7.499
	CD22-35	-22.49 to 15.00 to 22.49
	CD22-100	-74.99 to 50.00 to 74.99

* The default values are shown in bold.

● Screen transitions

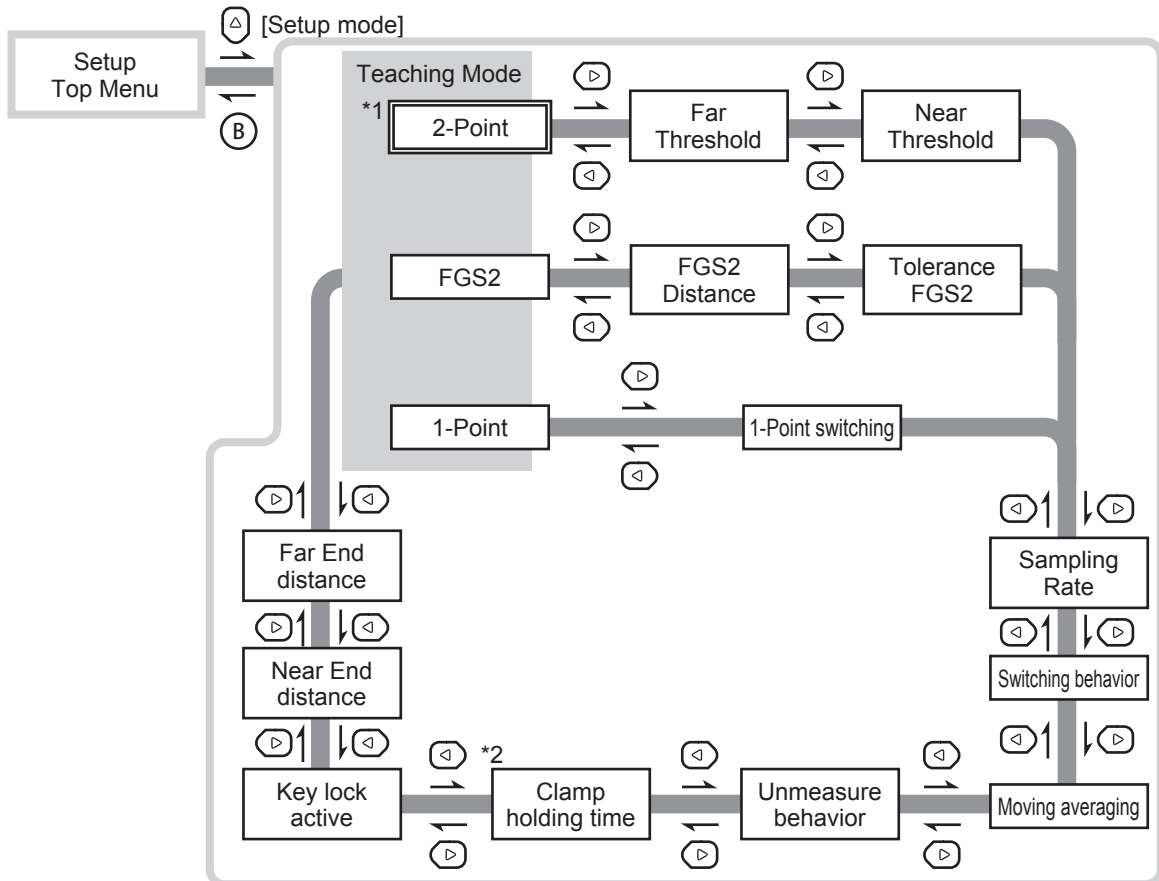

*1: This is the default value of [Teaching Mode].

If you execute [Reset Settings], the [Teaching Mode] screen is displayed with [2-Point] specified when you select [Setup Mode] on the Top Menu.

While the power is on, the screen on which you pressed (B) to return to the Top Menu will be the initial screen displayed the next time you select [Setup Mode] from the Top Menu.

Thereafter, the last menu that you used is displayed.

*2: This is only displayed when you set [Unmeasure behavior] to [Hold].

●●● MEMO ●●●

The menus that you transition to with ◀ and ▶ vary depending on the setting that you select for [Teaching Mode].

Expert Mode

Setting items

Screen name	Explanation and settable values/options	
Hysteresis	Set the hysteresis in relation to the sensor's judgment threshold to prevent chattering.	
	CD22-15	0.000 to 0.050 to 7.499
	CD22-35	0.00 to 0.15 to 22.49
	CD22-100	0.00 to 0.50 to 74.99
Barycenter	Normally use [Max light]. Max light /Closest/2nd Point/3rd Point/4th Point/5th Point	
Light threshold	Normally use [Lowest]. Use this setting to perform adjustments when detections are unstable due to the influence of noise. Lowest /Lower/Middle/Upper	
Zeroing value	Check or change the currently set zeroing value.	
	CD22-15	-7.499 to 0.000 to 7.499
	CD22-35	-22.49 to 0.00 to 22.49
	CD22-100	-74.99 to 0.00 to 74.99
Gain	Normally use [Auto adjust]. Fixing the gain improves the detection speed but measurement may not be possible due to the influence of the workpiece's color or materials. Auto adjust /Min Sense/2nd Sense/3rd Sense/4th Sense/5th Sense/Max Sense	
Key Lock	Enable/disable the CD22 key operations. Unlock /Lock	
Reset Settings	Initialize all the CD22 settings. Not Reset /Execute by <input type="checkbox"/>	

* The default values are shown in bold.

Screen transitions

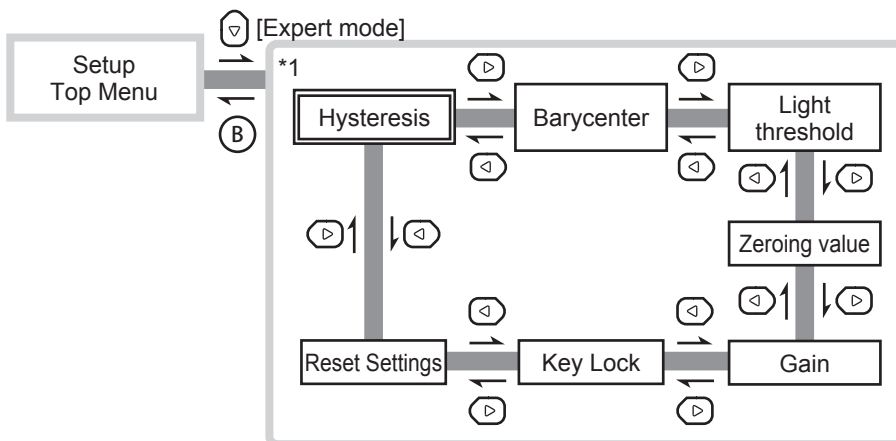

*1: Immediately after the power is turned on, this is the first screen displayed for the [Expert Mode] menu. Thereafter, the last menu that you used is displayed.

■ Teaching

● Setting items

Screen name	Explanation and settable values/options
Zeroing	Save the current measurement value as the zeroing value and set the measurement value display to 0.
Reset Zeroing	Set the Zeroing value to 0 and clear the offset.
Near switching Point	When the teaching mode is set to [2-Point], execute the teaching on the near side from the actual measurement value.
Far switching Point	When the teaching mode is set to [2-Point], execute the teaching on the far side from the actual measurement value.
FGS2 Distance	When the teaching mode is set to [FGS2 Distance], execute the FGS2 reference distance teaching from the actual measurement value.
1-Point	When the teaching mode is set to [1-Point], execute the teaching from the actual measurement value.
Specify Near End	Register the measurement value as the near end distance.
Specify Far End	Register the measurement value as the far end distance.

● Screen transitions

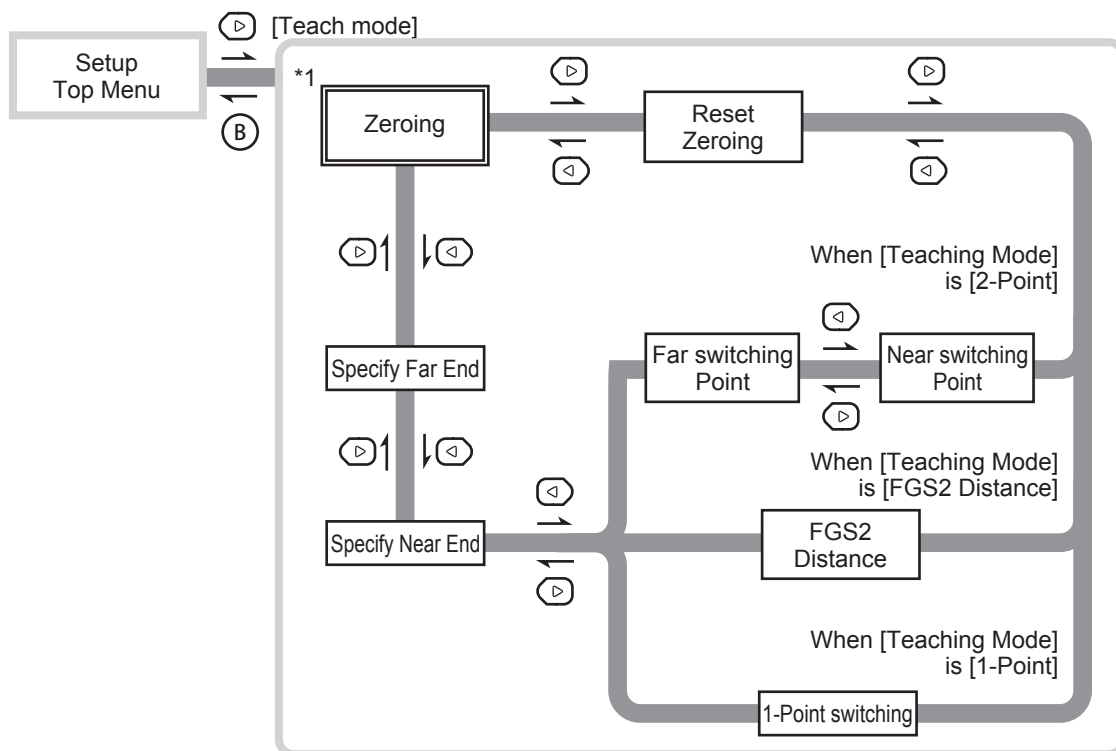

*1: This is the first screen displayed immediately after the power is turned on or after you execute [Reset Settings]. Thereafter, the last menu that you used is displayed.

4-1-2 Teaching

With the CD22, you can perform three types of teaching: "2-point teaching," "FGS2 teaching," and "1-point teaching."

2-point teaching

Perform teaching with two points and register both points as thresholds.

The Go on/off judgment is performed according to whether the measurement value is within the two thresholds during operation.

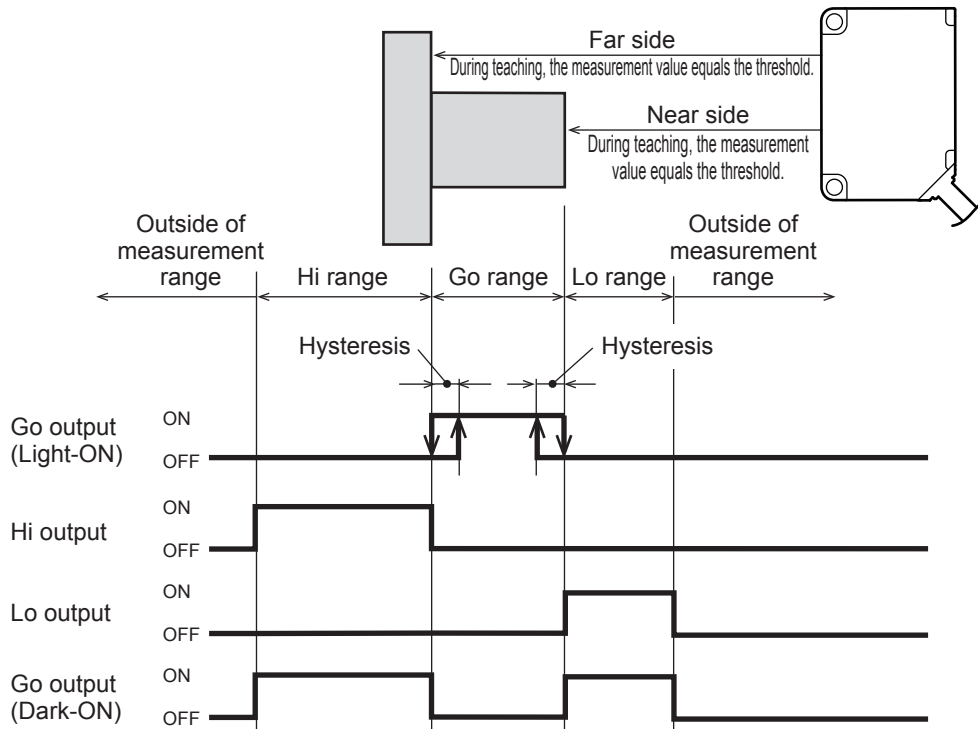

Executing 2-point teaching

This section explains how to perform teaching from the sensor's actual measurement value. You can execute 2-point teaching from the far side or from the near side, but this explanation will perform teaching from the near side followed by teaching from the far side as an example. Prepare a workpiece in advance so that the sensor detects the near side.

MEMO

- You can enter the thresholds manually from the [Setup Mode] menu. You can also set the switching behavior (Light-ON/Dark-ON) from the [Setup Mode] menu.
- From the [Expert Mode] menu, in addition to changing the zeroing value manually, you can also set the hysteresis value.
- From the [Teaching Mode] menu, you can execute and clear offsets as well as specify the near end/far end from the actual measurement value.

- 1 On the basic screen, press Δ or ∇ to select [Channel 1] or [Channel 2], and then press A .

The Setup Top Menu for the selected channel is displayed.

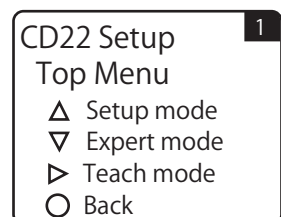

2 Press **[▲]**.
The display switches to the [Setup Mode] menu.

3 Use **[◀]** or **[▶]** to switch to the [Teaching Mode] screen.
The default value for the teaching mode is [2-Point], but a different setting is selected here as an example.

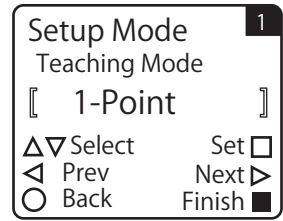

4 Use **[▲]** or **[▼]** to select [2-Point], and then press **[A]**.
The teaching mode is set to [2-Point].

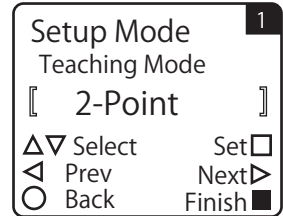

5 Press **[B]** to return to the Setup Top Menu, and then press **[▶]**.
The display switches to the [Teaching Mode] menu.

6 Use **[◀]** or **[▶]** to switch to the [Near switching Point] screen.

Currently registered threshold on the near end

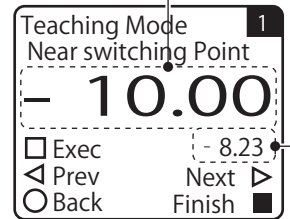

Current measurement value

7 Press **[A]** to execute the teaching on the near side.
When you execute the teaching on the near side, the near side threshold is overwritten with the current measurement value.

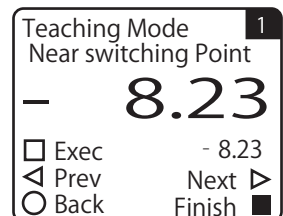

8 Move the workpiece so that the sensor detects the far side.

9 Press **[▶]**.
The display switches to the [Far switching Point] screen.

Currently registered threshold on the far end

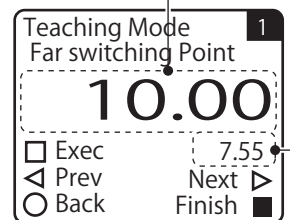

Current measurement value

10 Press (A) to execute the teaching on the far side.

When you execute the teaching on the far side, the far side threshold is overwritten with the current measurement value.

This completes the 2-point teaching procedure.

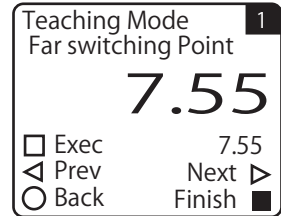

■ FGS2 teaching

Perform 1-point teaching to set the reference distance.

During operation, ON/OFF of the Go judgment is performed according to whether the measurement value is within the range of "reference distance ± operation distance" by using the operation distance set in advance.

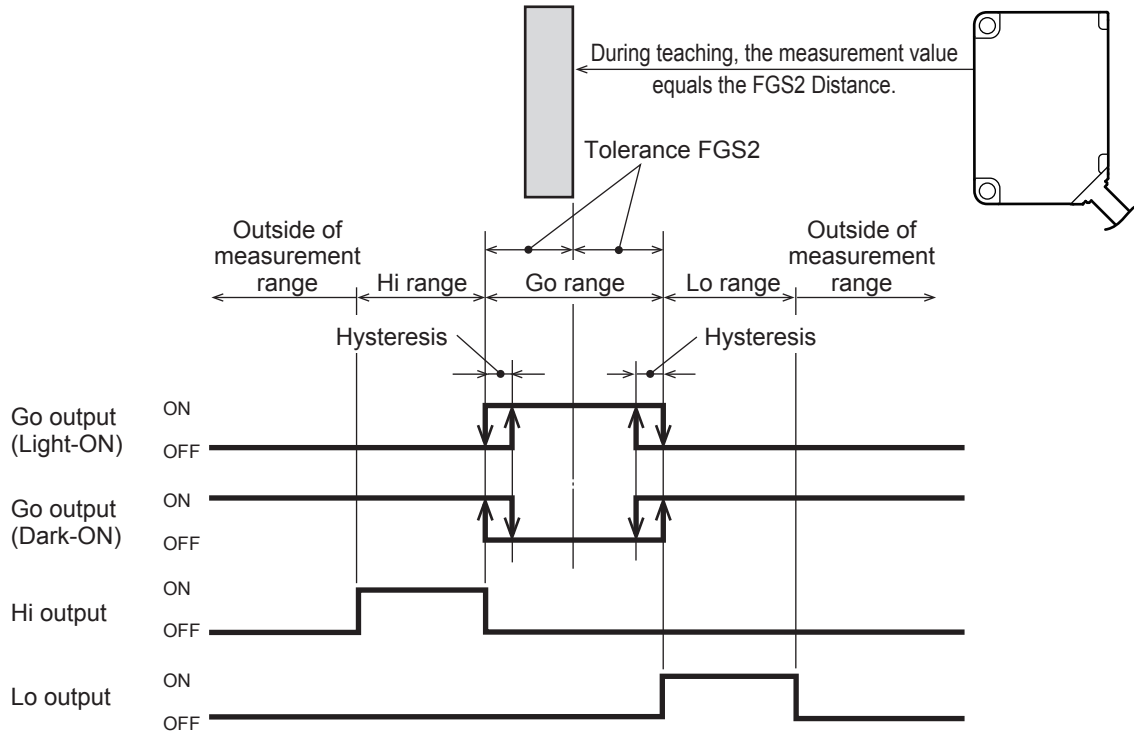

When detecting workpieces on a belt conveyor from above, the Go output will turn on when using the Dark-ON setting if the workpiece on the conveyor belt is outside of the detection range. For example, it is difficult to accurately detect the distance when the workpiece has a specular surface, but by using FGS2, it is possible to judge whether the workpiece is present on the basis of the Go output being on or off regardless of whether it is possible to actually detect the workpiece. In this manner, use FGS2 with Dark-ON operation when a reference background is present and the workpieces are closer to the sensor than the background (the reference distance) is.

MEMO

When the teaching mode is set to FGS2, Hi and Lo are judged. You can use Hi output/Lo output in the same manner as Go output.

● Executing FGS2 teaching

This section explains how to perform teaching from the sensor's actual measurement value. In advance, position the sensor and the reference background in the same manner as during actual operation.

●●● MEMO ●●●

- You can enter the FGS2 reference distance manually from the [Setup Mode] menu. You can also set the FGS2 operation distance and the switching behavior (Light-ON/Dark-ON) from the [Setup Mode] menu.
- From the [Expert Mode] menu, in addition to changing the zeroing value manually, you can also set the hysteresis value.
- From the [Teaching Mode] menu, you can execute and clear offsets as well as specify the near end/far end from the actual measurement value.

- 1** On the basic screen, press or to select [Channel 1] or [Channel 2], and then press .

The Setup Top Menu for the selected channel is displayed.

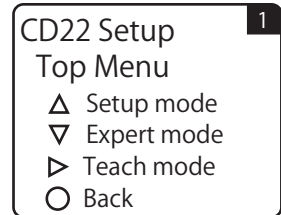

- 2** Press .

The display switches to the [Setup Mode] menu.

- 3** Use or to switch to the [Teaching Mode] screen.

The default value for the teaching mode is [2-Point].

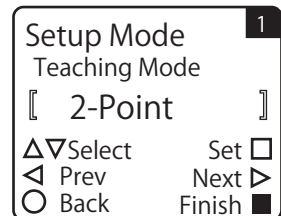

- 4** Use or to select [FGS2], and then press .

The teaching mode is set to [FGS2].

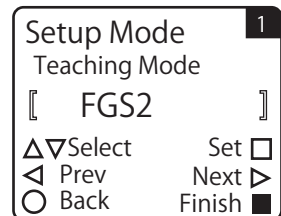

- 5** Press to return to the Setup Top Menu, and then press .

The display switches to the [Teaching Mode] menu.

- 6** Use or to switch to the [FGS2 Distance] screen.

Currently registered FGS2 reference value

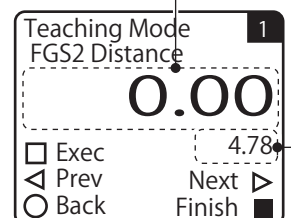

Current measurement value

7 Press **(A)** to execute the teaching.

When you execute the teaching, the FGS2 reference value is overwritten with the current measurement value.

This completes the FGS2 teaching procedure.

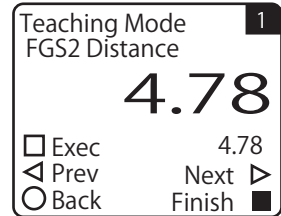

1-point teaching

Use the measurement value during teaching as the threshold.

The Go on/off judgment is performed according to whether the measurement value reaches the threshold during operation.

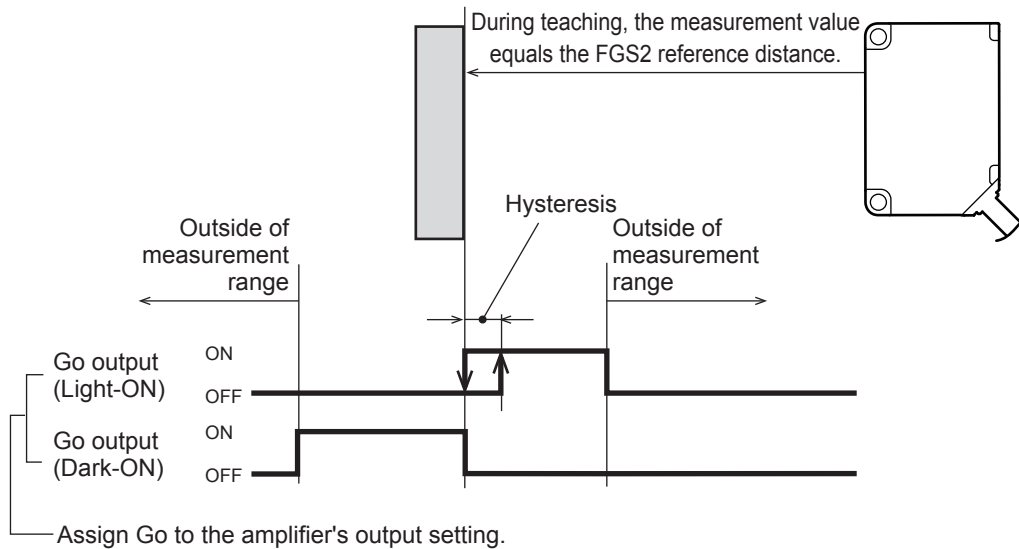

● Executing 1-point teaching

This section explains how to perform teaching from the sensor's actual measurement value. In advance, prepare a workpiece to use in teaching.

MEMO

- You can enter the threshold manually from the [Setup Mode] menu. You can also set the switching behavior (Light-ON/Dark-ON) from the [Setup Mode] menu.
- From the [Expert Mode] menu, in addition to changing the zeroing value manually, you can also set the hysteresis value.
- From the [Teaching Mode] menu, you can execute and clear offsets as well as specify the near end/far end from the actual measurement value.

1 On the basic screen, press **(▲)** or **(▼)** to select [Channel 1] or [Channel 2], and then press **(A)**.

The Setup Top Menu for the selected channel is displayed.

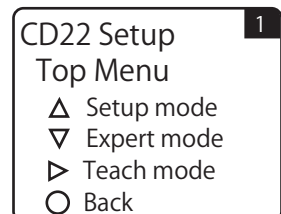

2 Press **(▲)**.

The display switches to the [Setup Mode] menu.

3 Use **[Left]** or **[Right]** to switch to the **[Teaching Mode]** screen.

The default value for the teaching mode is [2-Point].

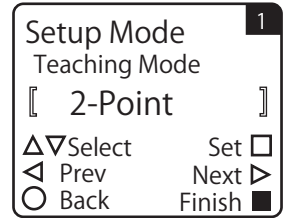

4 Use **[Up]** or **[Down]** to select **[1-Point]**, and then press **[A]**.

The teaching mode is set to [1-Point].

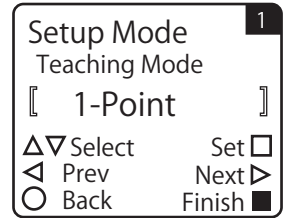

5 Press **[B]** to return to the **Setup Top Menu**, and then press **[Right]**.

The display switches to the [Teaching Mode] menu.

6 Use **[Left]** or **[Right]** to switch to the **[1-Point switching]** screen.

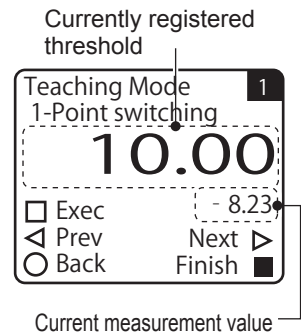

7 Press **[A]** to execute the teaching.

When you execute the teaching, the threshold is overwritten with the current measurement value. This completes the 1-point teaching procedure.

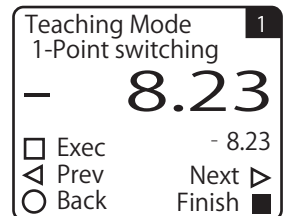

4-1-3 Alarm Settings for Measurement Error (When Measurement Is Not Possible)

■ Measurement error

With the CD22, you can select from two operations when measurement is not possible: [Clamp] or [Hold]. This section explains the procedure for setting the CD22's alarm operation from the CDA.

- 1 On the basic screen, press or to select [Channel 1] or [Channel 2], and then press .

The Setup Top Menu for the selected channel is displayed.

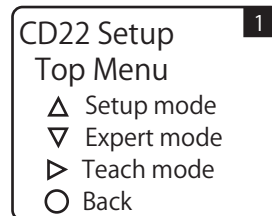

- 2 Press .

The display switches to the [Setup Mode] menu.

- 3 Use or to switch to the [Unmeasure behavior] screen.

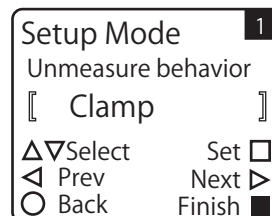

- 4 Use or to select the value for [Unmeasure behavior], and then press .

Unmeasure behavior	
Clamp	When measurement is not possible, the specified output is generated. In this situation, the output value is 9999.
Hold	When measurement is not possible, the previous measurement value is maintained.

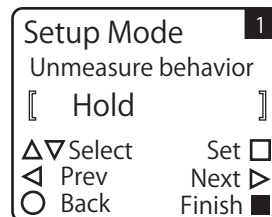

* The default value is shown in bold.

■ Clamp holding time

If you select [Hold] for [Unmeasure behavior], you can set the time for which to maintain the measurement value when measurement is not possible.

For example, when detecting a workpiece such as a printed circuit board that has multiple holes, such as that shown in the following figure, measurement is not possible at the hole positions.

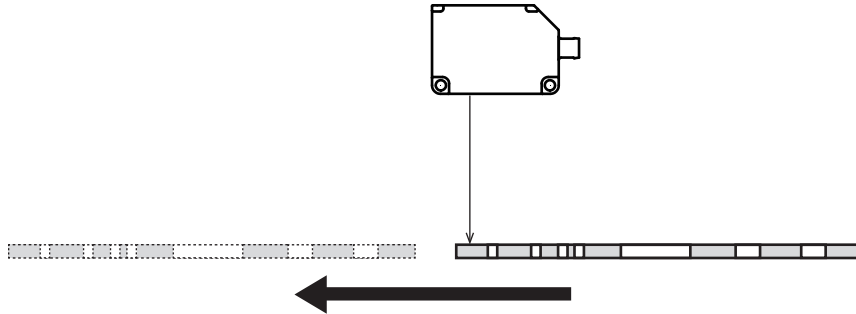

Setting [Unmeasure behavior] to [Clamp] does not suit this workpiece because it will frequently be impossible to perform measurement.

Just setting [Unmeasure behavior] to [Hold] maintains the detection status after the workpiece is first detected. This means that the presence and absence of both holes and the workpiece are ignored, which is not well-suited to the detection of the workpiece.

● Operation when Clamp is specified

Measurement is not possible outside of the workpiece and at the hole positions.

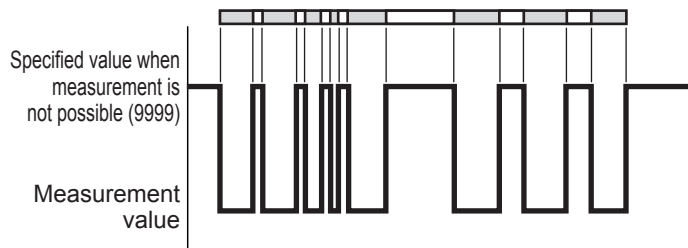

● Operation when only Hold is specified

After the workpiece is first detected, the detected status (measurement value) is maintained even when measurement is not possible.

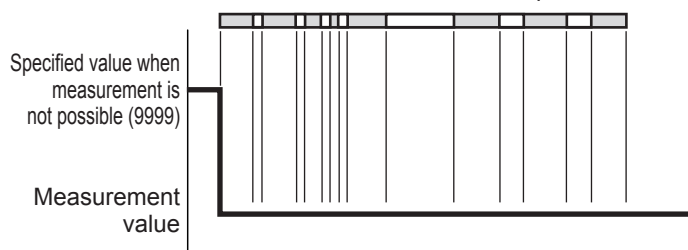

In order to accurately detect the presence and absence of a printed circuit board, it is necessary to not handle holes as impossible measurements and to set the measurement target as the case where the workpiece is present. Therefore, configure the settings to release the hold function's maintained detection status after a set length of time elapses. If you set [Clamp holding time] and [Sampling Rate], the detection status will be maintained only for the length of time specified by [Sampling Rate] × [Clamp holding time].

• **Operation when Hold is specified and Clamp holding time and Sampling Rate are set**

After the workpiece is detected, the detected status (measurement value) is maintained even when measurement is not possible due to holes in the workpiece. The held status is released if measurement is not possible for a length of time longer than that found by calculating ([Clamp holding time] × [Sampling Rate]).

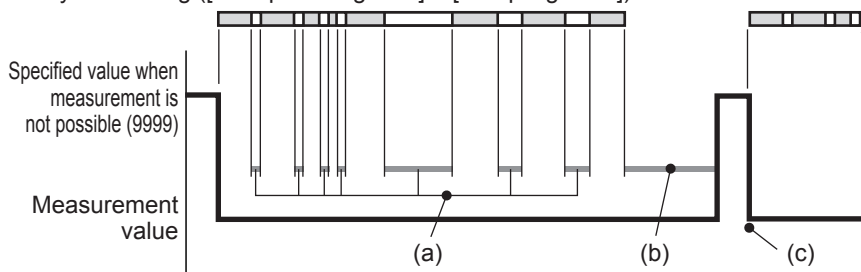

(a) The time that the detection laser passes the holes in the workpiece is less than or equal to ([Clamp holding time] × [Sampling Rate]) [maximum], so the measurement value is maintained.

(b) The time that the detection laser passes from one workpiece to the next one is greater than ([Clamp holding time] × [Sampling Rate]) [maximum], so the measurement value is released (measurement is not possible).

(c) The next workpiece is detected and the measurement value is acquired.

This section explains the procedure for setting the CD22's sampling rate and clamp holding time from the CDA.

- 1** Set [Unmeasure behavior] to [Hold].
See "Measurement error" (page 4-13).

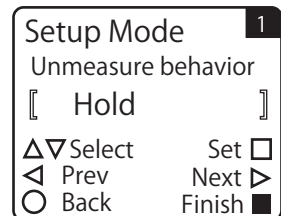

- 2** Press .
The display switches to the [Clamp holding time] screen.

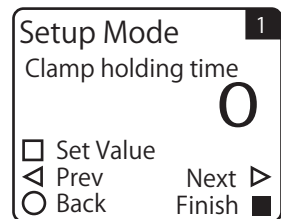

- 3** Set the clamp holding time.

Clamp holding time	Set the number of samples over which to allow measurement to continue even when measurement is not possible. 0 to 9999
---------------------------	--

* The default value is shown in bold.

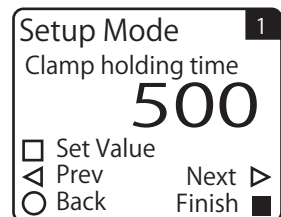

4 Use \leftarrow or \rightarrow to switch to the [Sampling Rate] screen.

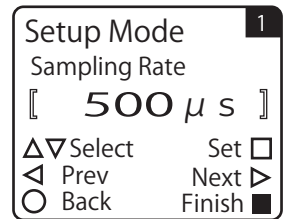

5 Use \uparrow or \downarrow to select the sampling rate, and then press (A).

Sampling Rate	Select the rate at which to perform measurement from the values shown below. 500 μs , 1000, 2000, 4000, Auto
----------------------	--

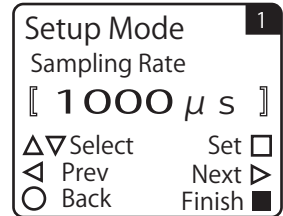

* The default value is shown in bold.

4-1-4 Correcting the Influence of Sensor Light Axis Tilt

With the factory settings, the CD22 is calibrated to match a distance fluctuation of 90° from the laser light axis. Therefore, if the CD22 is tilted in its installation position, errors will occur in the output value. For example, the measurement range for the CD22-100 is -50 mm to +50 mm. If the sensor is installed with a tilt of 5°, an error occurs in the output as calculated according to the following figure.

• Example: CD22-100

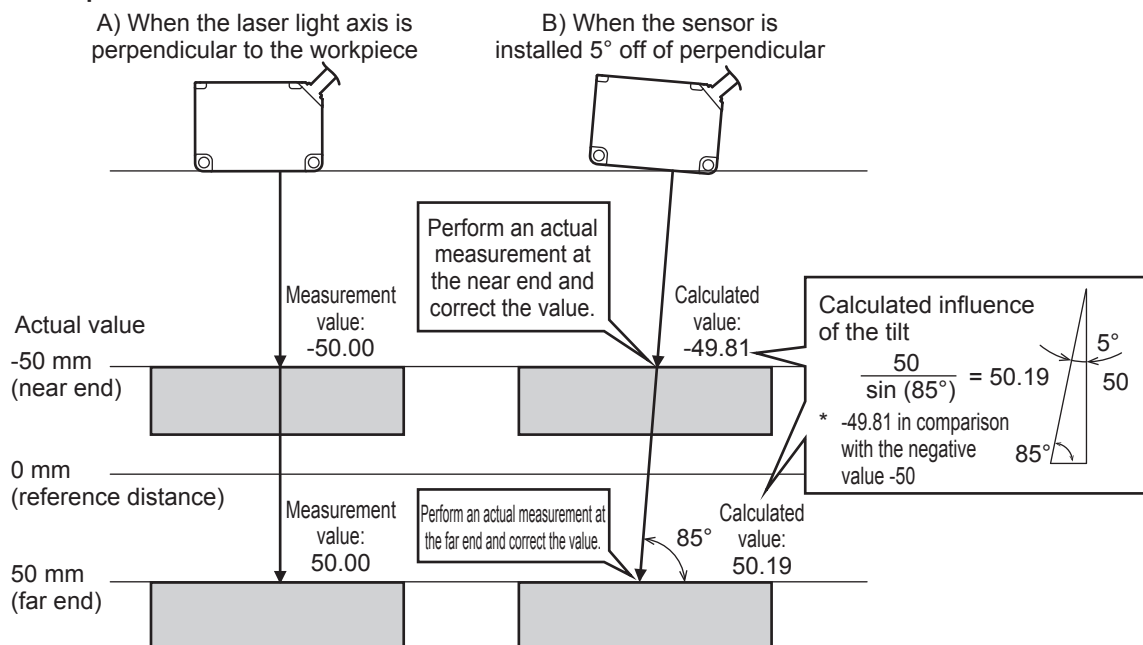

In this situation, it is possible to correct the actual measurement value with the sensor tilted (B in the above figure) to the measurement value with the perpendicular light axis (A in the above figure).



■ Performing corrections with the actual near-end and far-end measurements

This section explains how to correct the influence of the tilt of the CD22-100 installation position with the actual near-end and far-end measurements.

Prepare a workpiece in advance so that the measurement can be performed on the near end.



MEMO

When specifying the near end, perform the measurement at the shortest distance in the detection range wherever possible. In the same manner, when specifying the far end, perform the measurement at the longest distance in the detection range wherever possible.

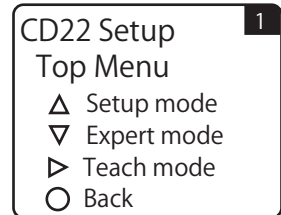
- 1 On the basic screen, press  or  to select [Channel 1] or [Channel 2], and then press . The Setup Top Menu for the selected channel is displayed.



- 2 Press . The display switches to the [Teaching Mode] menu.

- 3 Use  or  to switch to the [Specify Near End] screen. For the CD22-100, -50.00 is registered as the default value for the near end measurement value (Near End distance).

Registered actual measurement value on the near end

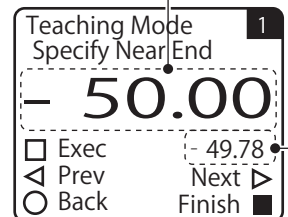

Current measurement value

- 4 Press  to execute the teaching of the near end specification. When you execute the teaching of the near end specification, Near End distance is overwritten with the current measurement value.

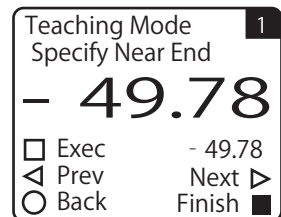

- 5 After you finish the near end teaching, prepare the workpiece so that the far end measurement can be performed.

- 6 Press . The display switches to the [Specify Far End] screen. For the CD22-100, 50.00 is registered as the default value for the far end measurement value (Far End distance).

Registered actual measurement value on the far end

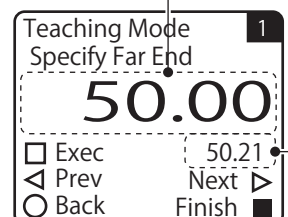

Current measurement value

- 7** Press **(A)** to execute the teaching of the far end specification. When you execute the teaching of the far end specification, Far End distance is overwritten with the current measurement value. This completes the procedure for correcting the tilt influence by performing teaching from actual measurement values.

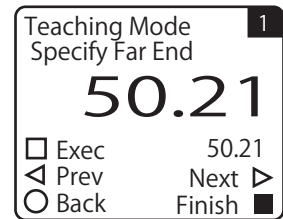

■ Performing corrections by entering numeric values

Calculate the influence of the tilt according to the example on 4-16. When the sensor's laser light axis is tilted by 5° (at an angle of 85° from the workpiece), the calculation becomes that shown in the figure on the right for the CD22-100.

Near End distance = -49.81
Far End distance = 50.19

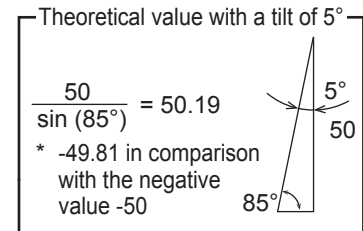

This section explains how to correct the influence of the tilt of the CD22-100 installation position by entering the numeric values calculated above.

Caution

Unless you have a special reason to do otherwise, correct the influence of light axis tilt by performing actual measurements of the near and far ends. For details on correcting the sensor light axis tilt with actual measurements, see "Performing corrections with the actual near-end and far-end measurements" (page 4-17).

- 1** On the basic screen, press **(▲)** or **(▼)** to select [Channel 1] or [Channel 2], and then press **(A)**. The Setup Top Menu for the selected channel is displayed.

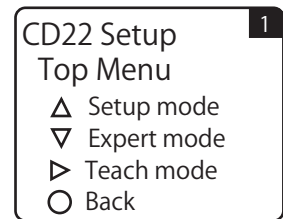

- 2** Press **(▲)**. The display switches to the [Setup Mode] menu.

- 3** Use **(◀)** or **(▶)** to switch to the [Near End distance] screen. For the CD22-100, -50.00 is registered as the default value for Near End distance.

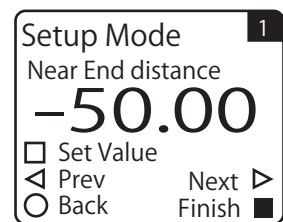

- 4** Change the near end distance to match the calculated value. The range of settings that are possible for the near end distance varies according to the sensor model (the center of measurement range).

Model	Near end distance correction range
CD22-15	-7.499 to 0.000 to 7.499
CD22-35	-22.49 to 0.00 to 22.49
CD22-100	-74.99 to 0.00 to 74.99

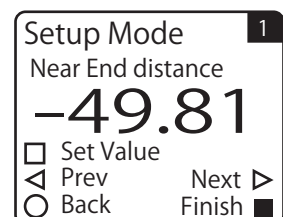

- 5** Press .
- The display switches to the [Far End distance] screen.
For the CD22-100, 50.00 is registered as the default value for Far End distance.

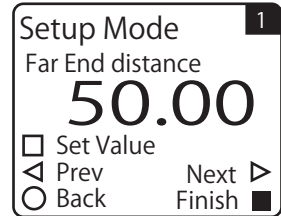

- 6** Change the far end distance to match the calculated value.
This completes the procedure for correcting the tilt influence by entering calculated values.

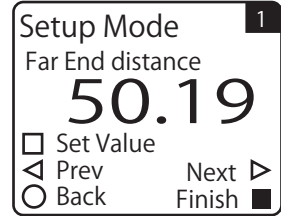

4-1-5 Initialization Settings

Follow the procedure shown below to initialize the CD22 settings with CDA operations. You can initialize each connected channel separately.

When you perform the initialization, all the CD22 settings—such as the changed correction of the influence of the sensor's light axis tilt, teaching method, and teaching result—are returned to their default values.

MEMO

There is no message or other confirmation when you execute the initialization. Exercise caution when initializing the settings.

- 1** On the basic screen, press or to select [Channel 1] or [Channel 2], and then press (A).
The Setup Top Menu for the selected channel is displayed.

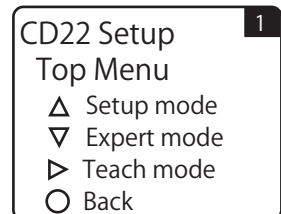

- 2** Press .
- The display switches to the [Expert Mode] menu.

- 3** Use or to switch to the [Reset Settings] screen.

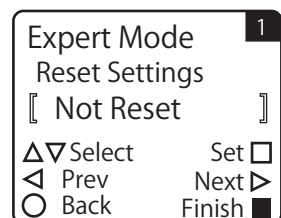

- 4** Use or to select [Execute by].
To initialize the settings, press (A) while [Execute by] is displayed.
Press (B) to cancel the initialization and return to the Setup Top Menu.

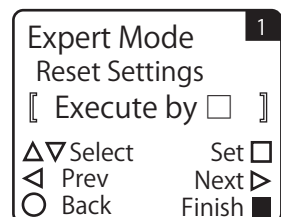

 **MEMO** 

When you initialize the sensor settings, the PWR indicator will light in red for an instant due to the initialization of the CD22 communication speed setting. Different from the initialization of the amplifier settings, the screen's display does not change.

4-2 TD1 Settings

4-2-1 Setting Items and Screen Transitions

Configure the TD1 settings by selecting the channel for which the settings will be changed from the "basic screen."

There are two types of setting items.

● Amplifier unit channel selection menu

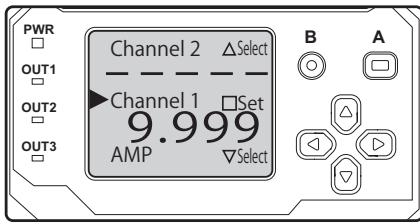

  button: Select/  button: Set

[To the TD1 series menu]
Select the channel for which the settings will be changed.

[To the amplifier unit menu]
Select "AMP."

- For details on how to change the amplifier unit settings, see the CDA series manual.

● TD1 series Top Menu

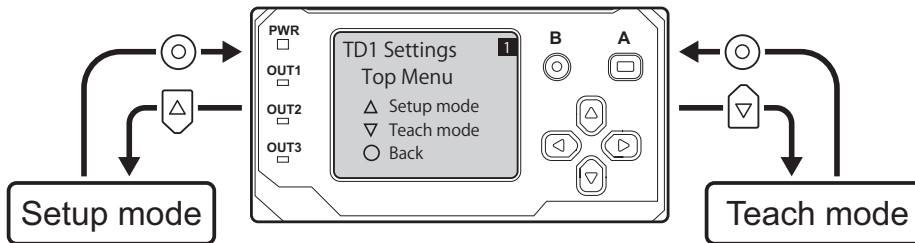

● Setup mode menu

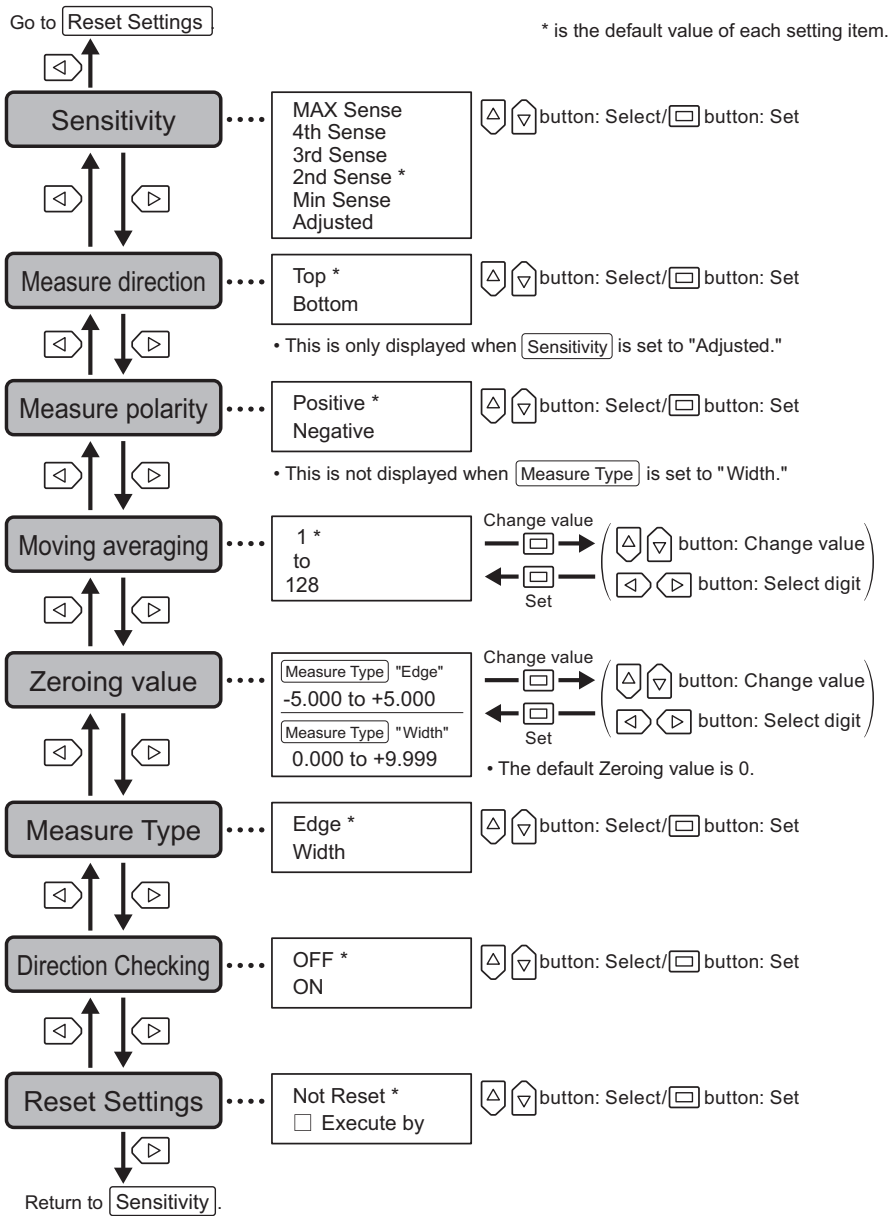

● Teaching menu

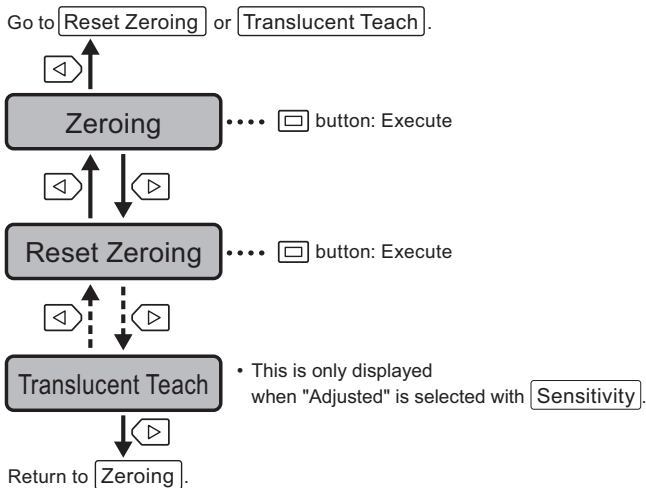

4-3 Measurement Type Setting

4-3-1 Edge Measurement and Width/Gap Measurement

The TD1 Series is capable of two types of measurement: “Edge” (single edge measurement) and “Width” (width or gap measurement).

● To measure the edge of the target

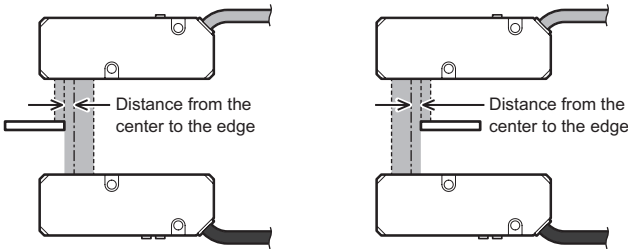

The displacement from the center of the light axis for a single edge is measured. The target insertion direction can be set to either Top or Bottom. Measurement cannot be performed if two or more edges exist within the measurement range.

● To measure the target width or the gap between targets

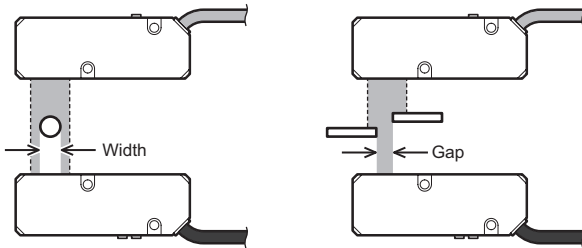

The distance between two edges will be measured. You can measure either the target width or the gap between two targets. Measurement cannot be performed if only one edge exists or three or more edges exist within the measurement range.

4-3-2 Switching Between Edge Measurement and Width/Gap Measurement

Edge measurement is set by default.

■ Setting the Measurement Type

For the settings menus, see "4-2 TD1 Settings" (page 4-21).

1 Select the channel for which the settings will be changed.

Press the up or down button to select a channel, and then press the A button.

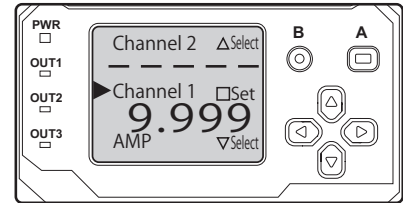

2 Select "Setup mode."

Press the up button.

3 Use the left or right button to select "Measure Type."

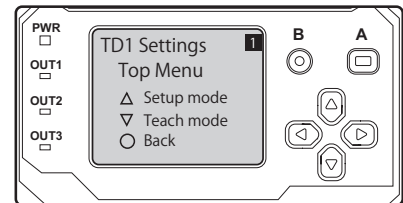

4 Change the measurement type.

■ When measuring the edge of an end surface

Select "Edge" for edge measurement.

■ When measuring the gap or width

Select "Width" for width or gap measurement.

Press the up or down button to change the measurement type, and then press the A button.

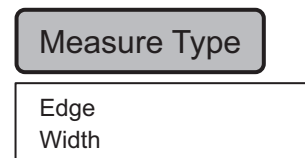

4-4 Measurement Polarity Setting

Select whether to set the top side to -5.000 mm and the bottom side to +5.000 mm or vice-versa when measuring edge positions.

The "Measure polarity" setting is only enabled during "Edge" measurement.

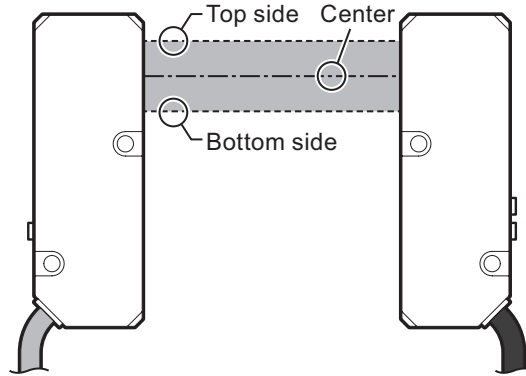

4-4-1 Measurement Polarity Options

The "Measure polarity" setting can be set to either "Positive" or "Negative." "Positive" is set by default.

Values when "Positive" is selected: Top side: -5.000 mm, Bottom side: +5.000 mm, Center: 0 mm

Values when "Negative" is selected: Top side: +5.000 mm, Bottom side: -5.000 mm, Center: 0 mm

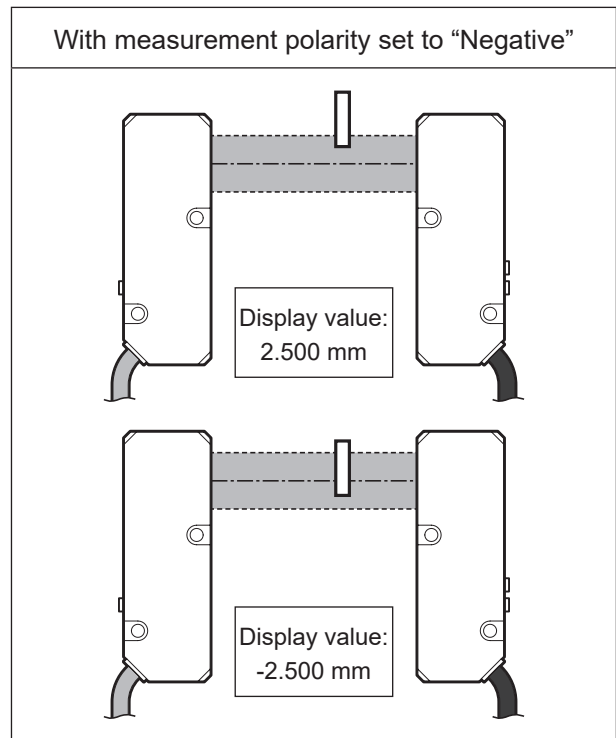
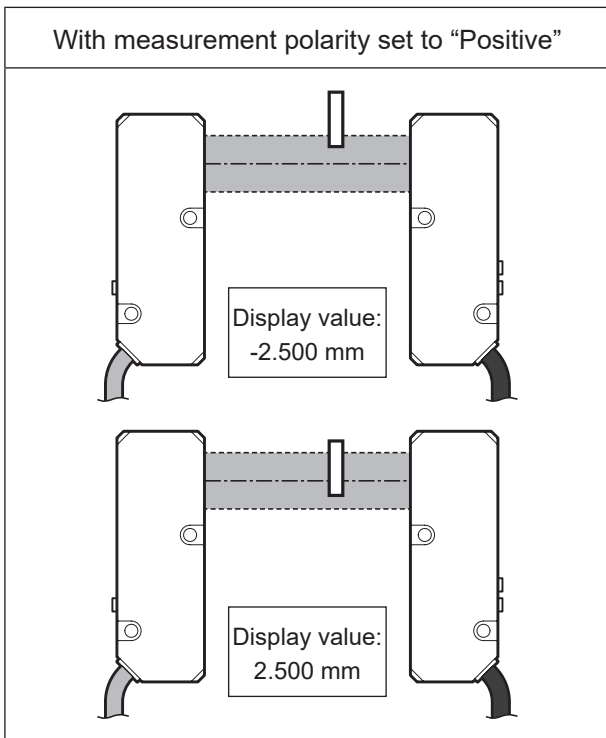

4-4-2 Measurement Polarity Setting

This section explains how to set “Measure polarity” to “Positive” or “Negative.”

■ Setting Measurement Polarity

For the settings menus, see "4-2 TD1 Settings" (page 4-21).

1 Select the channel for which the settings will be changed.

Press the up or down button to select a channel, and then press the A button.

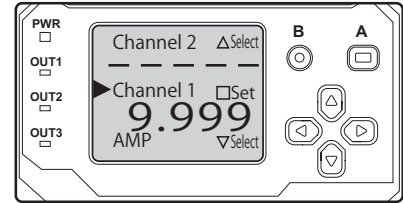

2 Select “Setup mode.”

Press the up button.

3 Use the left or right button to select “Measure polarity.”

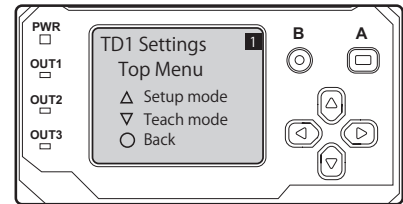

4 Change the measurement polarity.

- **Setting “Measure polarity” to “Positive”**
Select “Positive” for the measurement polarity.

- **Setting “Measure polarity” to “Negative”**
Select “Negative” for the measurement polarity.

Press the up or down button to change the measurement polarity, and then press the A button.

* “Positive” is set by default.

Measure polarity

Positive
Negative

4-5 Measuring Transparent Objects

4-5-1 Sensitivity Adjustment For Transparent Objects

This function is useful when the measurement target has a high transmittance and the measurement is not stable with preset “sensitivity” values. Set the sensitivity setting to “Adjusted,” and then perform translucent teaching. “Adjusted” can only be selected for edge measurement. This option cannot be selected for gap/width measurement.

■ Setting for Transparent Objects

For the settings menus, see "4-2 TD1 Settings" (page 4-21).

- 1 Select the channel for which the settings will be changed.**
Press the up or down button to select a channel, and then press the A button.
- 2 Select “Setup mode.”**
Press the up button.
- 3 Select “Sensitivity.”**
Use the left or right button to select “Sensitivity.”
- 4 Select “Adjusted.”**
Press the up or down button to select “Adjusted,” and then press the A button.
- 5 Go back to the TD1 series Top Menu.**
Press the B button.
- 6 Select “Teach mode.”**
Press the down button.
- 7 Use the left or right button to select “Translucent Teach.”**
- 8 Execute Teaching.**
With no measurement target being used and with “Translucent Teach” selected, press the A button.

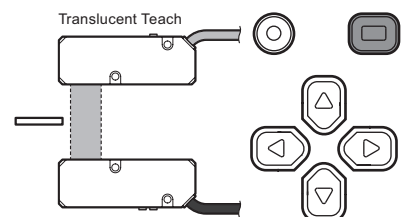
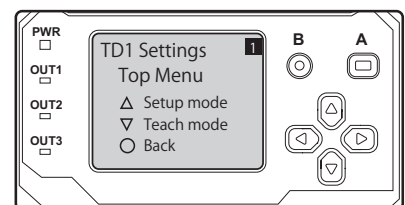
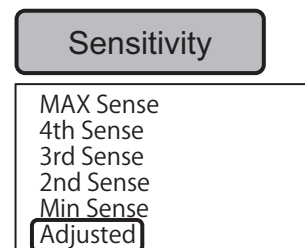
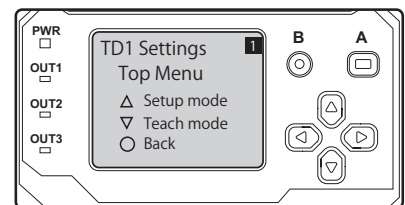
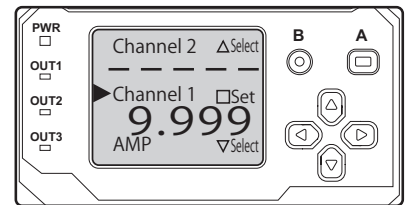

Caution

Following translucent teaching (after pressing the A button), the optimum sensitivity will be applied.

However, detection may not be possible in the case of highly transparent objects.

* Even though no completion message will be displayed, the settings will be applied when the A button is pressed.

4-5-2 Measurement Direction Setting

When setting sensitivity to “Adjusted,” setting the insertion direction of the workpiece is required.

- **Inserting a measurement target from the top**

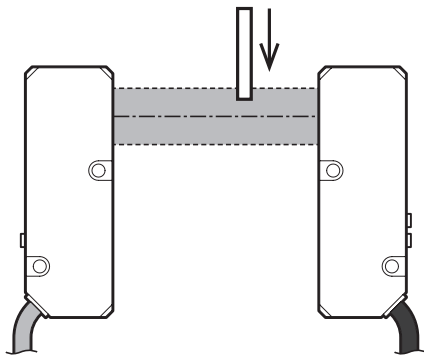

- **Inserting a measurement target from the bottom**

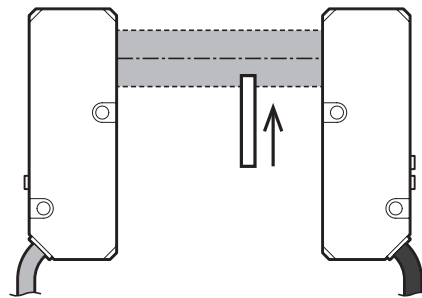

The default setting is for measurement to be performed for targets inserted from the top.

■ Setting Measurement Direction

For the settings menus, see "4-2 TD1 Settings" (page 4-21).

1 Select the channel for which the settings will be changed.

Press the up or down button to select a channel, and then press the A button.

2 Select "Setup mode."

Press the up button.

3 Use the left or right button to select "Measure Direction."

4 Select "Measure Direction."

- When inserting a measurement target from the top
Select "Top" for the measurement direction.

- When inserting a measurement target from the bottom
Select "Bottom" for the measurement direction.

Press the up or down button to change the measurement direction, and then press the A button.

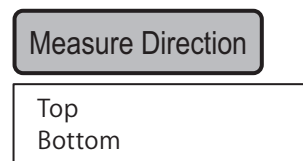
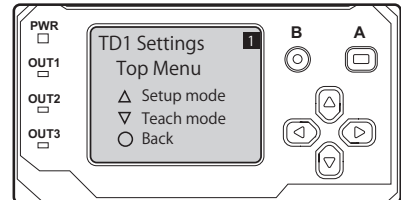
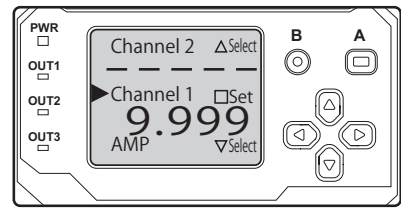

4-6 Zero Teaching

4-6-1 Zeroing

The measurement center position can be set (offset) to any position. This zeroing function is useful for checking the displacement amount from the reference position.

● Edge measurement

Measurement value when "Measure polarity" is set to "Positive":

Top side: -5.000 mm

Bottom side: +5.000 mm

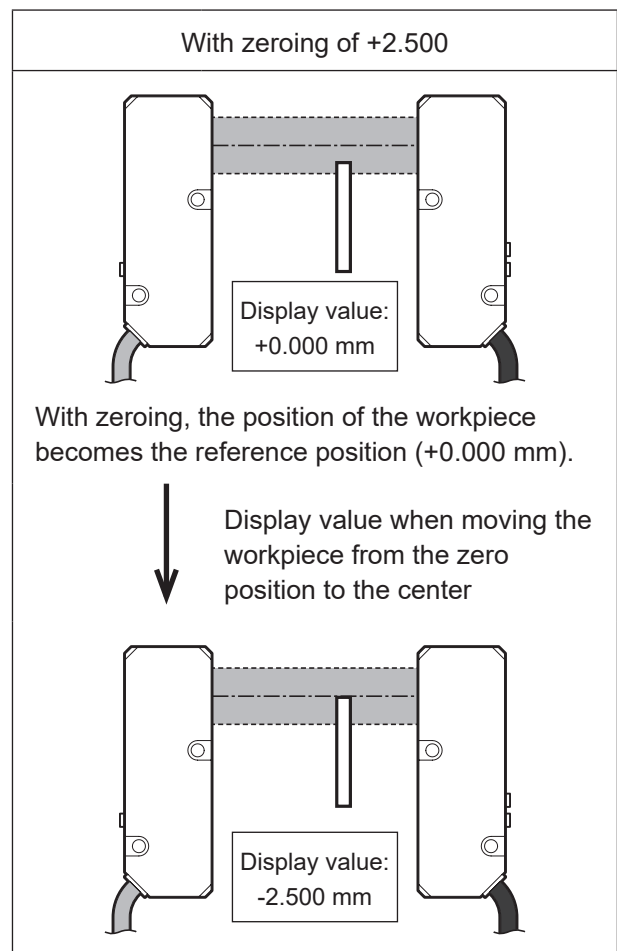
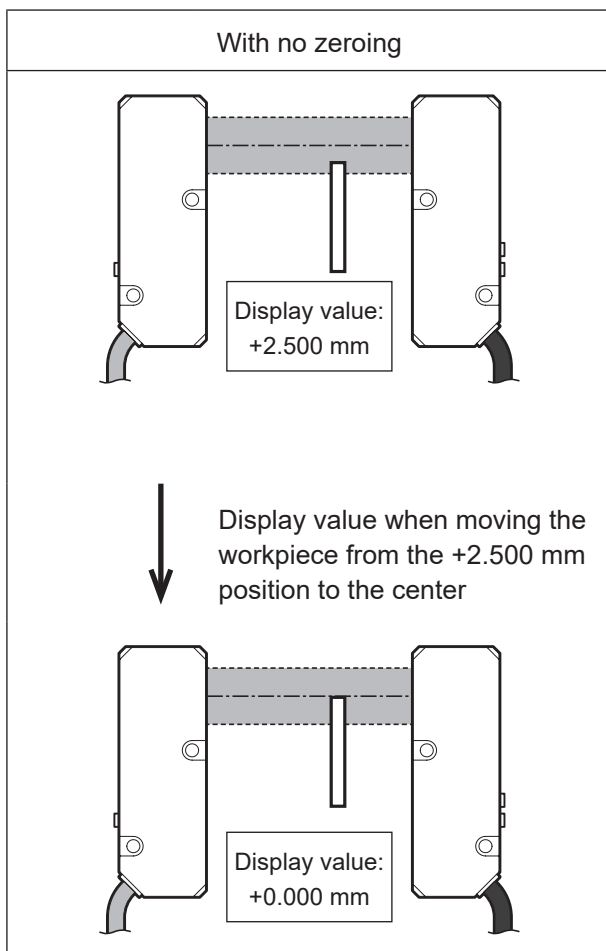

● Width/gap measurement

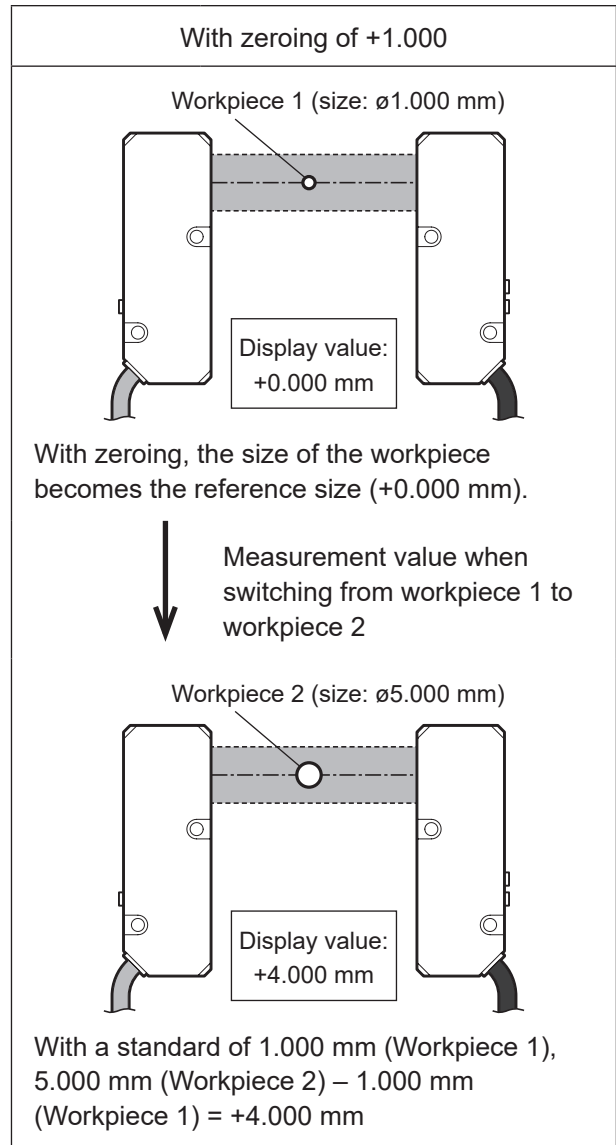
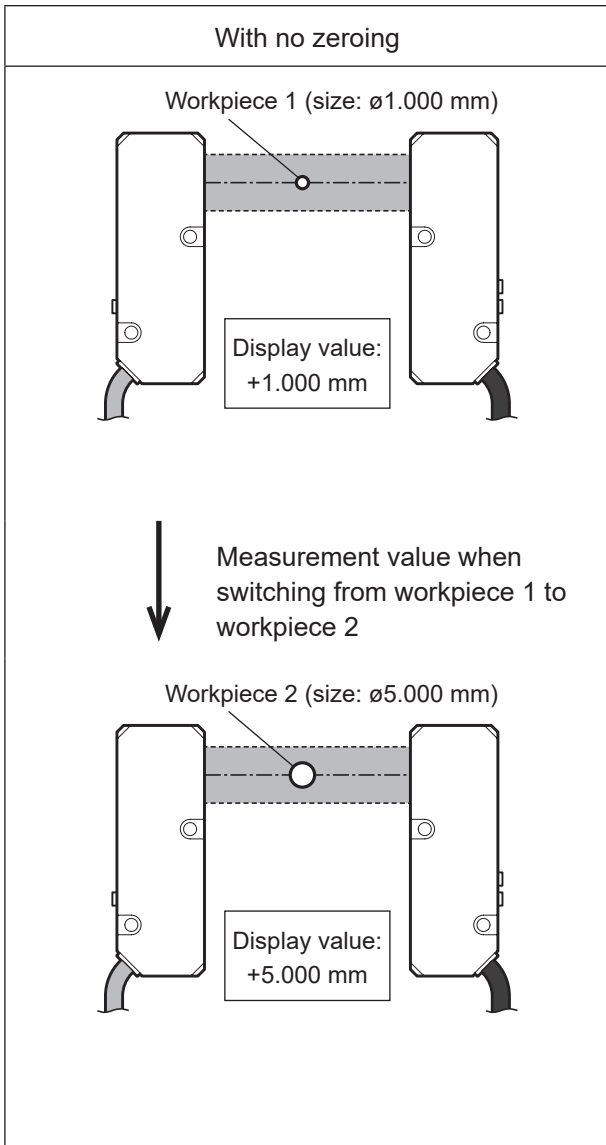

4-6-2 Zeroing

This section explains how performing zeroing.

Zeroing: Sets the measurement center position to any position.

Useful for checking the displacement amount from the reference position.

■ Performing Zeroing

For the settings menus, see "4-2 TD1 Settings" (page 4-21).

1 Select the channel for which the settings will be changed.

Press the up or down button to select a channel, and then press the A button.

2 Select "Teach mode."

Press the down button.

3 Select "Zeroing."

Use the left or right button to select "Zeroing."

4 Execute Zeroing.

Place the measurement target in the desired reference position, and press the A button with "Zeroing" displayed.

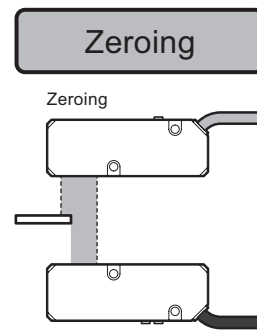
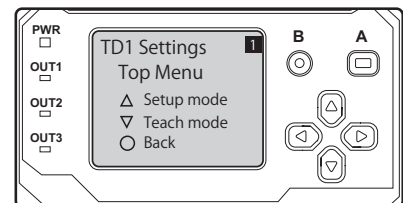
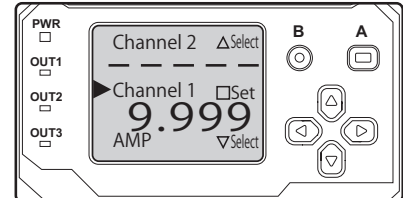

4-6-3 Checking/Resetting Zeroing Value

■ Checking or Changing a Zeroing Value

For the settings menus, see "4-2 TD1 Settings" (page 4-21).

- 1 Select the channel for which the settings will be changed.**
Press the up or down button to select a channel, and then press the A button.
- 2 Select "Setup mode."**
Press the up button.
- 3 Use the left or right button to select "Zeroing value."**
- 4 Select "Zeroing value."**
The currently set zeroing value will be displayed. Press the A button to change the zeroing value.
Up/down button: Change value
Left/right button: Select digit
A button: Set
* For information on changing the values, refer to the memo on page 3-35.
 - The default Zeroing value is 0.

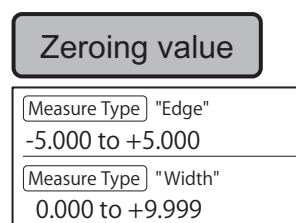
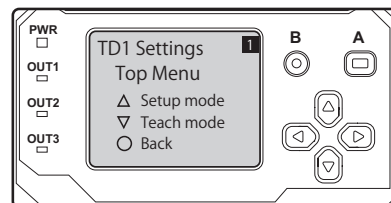
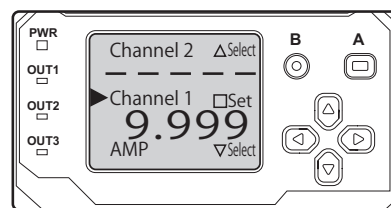

■ Resetting the Zeroing Value

For the settings menus, see "4-2 TD1 Settings" (page 4-21).

- 1 Select the channel for which the settings will be changed.**
Press the up or down button to select a channel, and then press the A button.
- 2 Select "Teach mode."**
Press the down button.
- 3 Use the left or right button to select "Reset Zeroing."**
- 4 Execute Resetting.**
Press the A button with "Reset Zeroing" displayed.

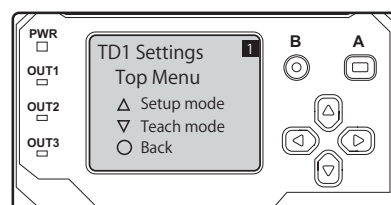
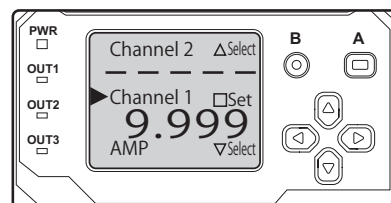

4-7 CDX Settings

4-7-1 Setting Items and Screen Transitions

● Amplifier unit channel selection menu

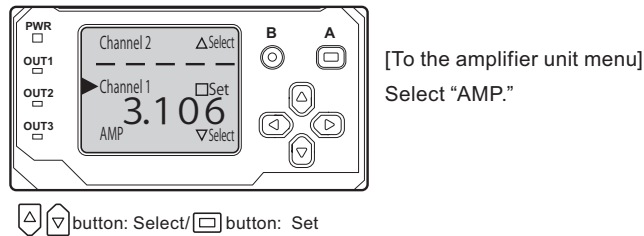

● Amplifier unit Top Menu

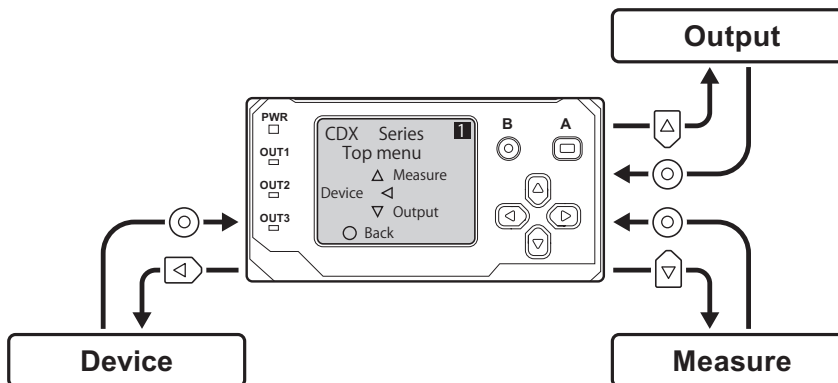

Device

Configure the mounting mode selection, initialization, external input operation, and laser ON/OFF settings.
→For details of setting items and screen transitions, see "Device" (page 4-36)

Output

Configure the judgment output and alarm settings.
→For details of setting items and screen transitions, see "Output" (page 4-36)

Measure

Configure the sampling period, measurement target selection, received light waveform, filter, moving average, and hold settings.
→For details of setting items and screen transitions, see "Measure" (page 4-35)

4-7-2 List of Setting Items

Caution

CDX Series products do not support field network communication.

The settings and parameters are listed here.

For details on each item, see the “CDX series user’s manual.”

Caution

- When using with a CDA Series device, some CDX Series settings cannot be checked/changed.
- Configurable/usable outputs are limited to Ch 1 in CDX Series products.
- The “Storage One-Shot” action cannot be used with a CDA connected.

● Measure

Setting items

Item name	Selection / Input item
Sampling period	[12.5 μ s] [25 μ s] [50 μs] [100 μ s] [200 μ s] [500 μ s] [1000 μ s] [Auto]
Sampling — Crop (12.5 μ s)	[Near] [Center] [Far]
Sampling — Upper Limit	[25 μ s] [50 μ s] [100 μ s] [200 μ s] [500 μ s] [1000 μs]
Sampling — Lower Limit	[25 μs] [50 μ s] [100 μ s] [200 μ s] [500 μ s] [1000 μ s]
Process — Object	[Standard] [Thin Glass] [Standard2]
Process — Measure	[Displacement] [Thickness] [Velocity]
Process — Peak Numbering	[from Near] [from Far]
Process — Peak No.	[Peak 1] [Peak 2] [Peak 3] [Peak 4] [Peak 5] [Peak 6] [Peak 7] [Peak 8]
Process — Thickness — Peak No.	[Peak 1] [Peak 2] [Peak 3] [Peak 4] [Peak 5] [Peak 6] [Peak 7] [Peak 8]
Process — Median	[Off] [7] [15] [31]
Process — Moving Average	[1] [2] [4] [8] [16] [32] [64] [128] [256] [512] [1024] [2048] [4096] [8192] [16384] [32768] [65536]
Process — Edge Measureing	[0000] (0 to 9999)
Process — Hold	[Off] [Peak] [Bottom] [Sample Hold] [Auto Peak] [Auto Bottom] [Peak-to-peak] [Normal]

* The default value is shown in bold.

● Device

Setting items

Item name	Selection / Input item
Device — Mounting	[Diffuse] [Specular]
Device — Direction	[Near+] [Far+]
Device — Factory Reset	[Cancel] [Execute]
Device — External Input	[None] [Laser Off] [Offset] [Hold] [Storage]
Device — Laser	[Enable] [Disabled]

* The default value is shown in bold.

● Output

Setting items

Item name	Selection / Input item
Output — Upper Limit	[+0.100] (15 mm type) (–9.998 to +9.999) [mm] [+0.500] (30 mm type) (–9.998 to +9.999) [mm] [+2.00] (85 mm type) (–99.98 to +99.99) [mm] [+4.00] (150 mm type) (–99.98 to +99.99) [mm]
Output — Lower Limit	[–0.100] (15 mm type) (–9.998 to +9.999) [mm] [–0.500] (30 mm type) (–9.998 to +9.999) [mm] [–2.00] (85 mm type) (–99.98 to +99.99) [mm] [–4.00] (150 mm type) (–99.98 to +99.99) [mm]
Output — Span value	[+1.000] (–2.000 to –0.100, +0.100 to +2.000)
Output — Offset value	[00.00] (15 mm type) (–9.998 to +9.999) [mm] [00.00] (30 mm type) (–9.998 to +9.999) [mm] [00.00] (85 mm type) (–99.98 to +99.99) [mm] [00.00] (150 mm type) (–99.98 to +99.99) [mm]
Output — Hysteresis	[+0.000] (0.000 to +9.999) [mm]
Output — ON Delay	[0] (0 to 4.000) [s]
Output — OFF Delay	[0] (0 to 4.000) [s]
Output — One shot	[Off] [On]
Alarm — Direction	[Clamp] [Hold] [Delayed Clamp]
Alarm — Alarm Delay	[0] (0 to 4095)
Alarm — Alarm Recovery	[0] (0 to 4095)

* The default value is shown in bold.

Caution

When using the external input terminal, set [External Input Selection] under [Amplifier Settings] → [I/O Settings] to [Laser Off].

4-7-3 Analog Output Settings

- Method of analog outputting on the CDA-DM2 using the CDX-L15A/-LW15A resolution 0.01 μm (for analog voltage outputs)

- Set analog Scaling Max to 295

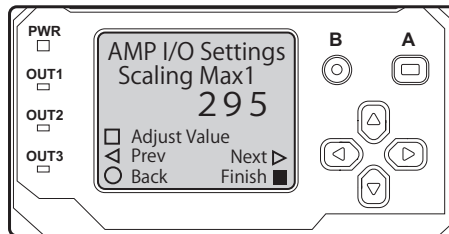

- Set analog Scaling Min to -295

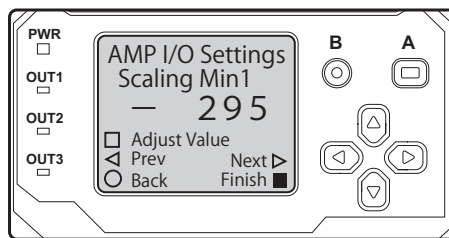

*For the analog output setting method, see "Analog Scaling Settings" (page 3-39).

*For other models, configure the settings based on the table in see "CDX analog output resolution" (page 4-38).

■ CDX analog output resolution

● CDA-DM2: For analog voltage output

Model	Measurement Scale		Analog Output Scale	
	Measurement range	Resolution	Measurement range	Resolution
CDX-L15A/-LW15A	+/-1.0 mm	0.25 μm	+/-1.0 mm	0.25 μm
CDX-30A/-W30A	+/-5.0 mm	0.25 μm	+/-5.0 mm	0.25 μm
CDX-85A/-W85A	+/-20.0 mm	0.68 μm	+/-7.375 mm	0.25 μm
CDX-150A/-W150A	+/-40.0 mm	1.36 μm	+/-7.375 mm	0.25 μm

● CDA-DM2: For analog current output

Model	Measurement Scale		Analog Output Scale	
	Measurement range	Resolution	Measurement range	Resolution
CDX-L15A/-LW15A	+/-1.0 mm	0.25 μm	+/-1.0 mm	0.25 μm
CDX-30A/-W30A	+/-5.0 mm	0.25 μm	+/-5.0 mm	0.25 μm
CDX-85A/-W85A	+/-20.0 mm	0.93 μm	+/-5.375 mm	0.25 μm
CDX-150A/-W150A	+/-40.0 mm	1.86 μm	+/-5.375 mm	0.25 μm

● For the CDA-M/DM

Model	Resolution
CDX-L15A/-LW15A	+/-1.0 mm
CDX-30A/-W30A	
CDX-85A/-W85A	+/-10.0 mm
CDX-150A/-W150A	

*The above values are the figures from dividing the measurement range with analog resolution (voltage 59000step, current 43000step).

A device that can capture analog values with 169 μV step and 0.37 μA step is required.

4-7-4 Initialization Settings

Follow the procedure shown below to initialize the CDX Series settings with CDA Series operations. When performing initialization, all the CDX Series settings are returned to their default values.

MEMO

- There is no message or other confirmation when you execute the initialization. Exercise caution when initializing the settings.
- All of the settings—including those not accessible/configurable with the CDA Series—are initialized.

- 1** On the basic screen, press [Δ] or [∇] to select [Channel 1] or [Channel 2], and then press [A].

The sensor settings top menu for the selected channel is displayed.

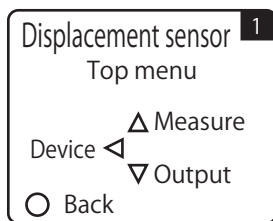

- 2** Press [\leftarrow].

The display switches to the [Device Settings] menu.

- 3** Use [\leftarrow] or [\rightarrow] to switch to the [Factory Reset] screen.

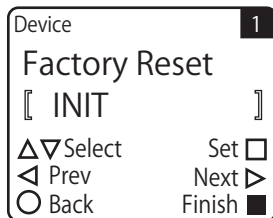

- 4** Use [Δ] or [∇] to select [\square INIT].

To initialize the settings, press [A] while [\square INIT] is displayed.

Press (B) to cancel the initialization and return to the sensor settings top menu.

4-8 Specifications

4-8-1 Specifications

The CDA specifications are shown below. For the specifications of compatible sensors, see their respective instruction manuals.

Type		Analog output × 1 + external input × 2		Analog output × 2
		Master unit	Slave unit	Master unit
Model		CDA-M	CDA-S	CDA-DM2
Compatible displacement sensors	Supported models	CDX series CD22 series (RS-485 types) TD1 series		
	Number of connectable units	Max. 2 units		
	Connection type	Amplifier side: M8, 4-pin connector		
Rating	Power supply voltage	12 to 24 VDC ±10%, including 10% ripple (p-p)		
	Current consumption	100 mA or less (at 12 V)	100 mA or less (at 12 V)	120 mA or less (at 12 V)
Display	Dot matrix display	OLED 128 × 96 pixels		
	Indicators	Power indicator: red/green, output indicator: orange		
Analog output	No. of outputs	1	1	2
	Type	4 to 20 mA/F.S. Load impedance: 300 Ω or less	4 to 20 mA/F.S. Load impedance: 300 Ω or less	4 to 20 mA, Load impedance: 300 Ω or less 0 to 10 V, output impedance: 100 Ω (selectable by setting)
Control output	No. of outputs	3	3	2
	Type	NPN/PNP open collector (selectable by setting) Max. 100 mA / 30 VDC, Residual voltage: 1.8 V or less		
External input		2 inputs	2 inputs	1 input
Environmental resistance	Ambient temperature/humidity	-20 to +50°C/35 to 85%RH (no freezing or condensation)		
	Storage temperature/humidity	-20 to +60°C/35 to 85%RH (no freezing or condensation)		
	Vibration resistance	10 to 55 Hz; double amplitude 1.5 mm; 2 hours in each of the X, Y, and Z directions		
	Shock resistance	Approx. 50 G (500 m/s ²), 3 times in each of the X, Y, and Z directions		
	Protection circuit	Reverse connection protection, overcurrent protection		
	Degree of protection	IP50		
Applicable regulations	EMC	EMC directive (2014/108/EU)		
	Environment	RoHS directive (2011/65/EU), China RoHS (Directive No. 32)		
NRTL Certification		UL Recognition		
Material		Polycarbonate		
Weight		170 g		

4-8-2 Dimensions

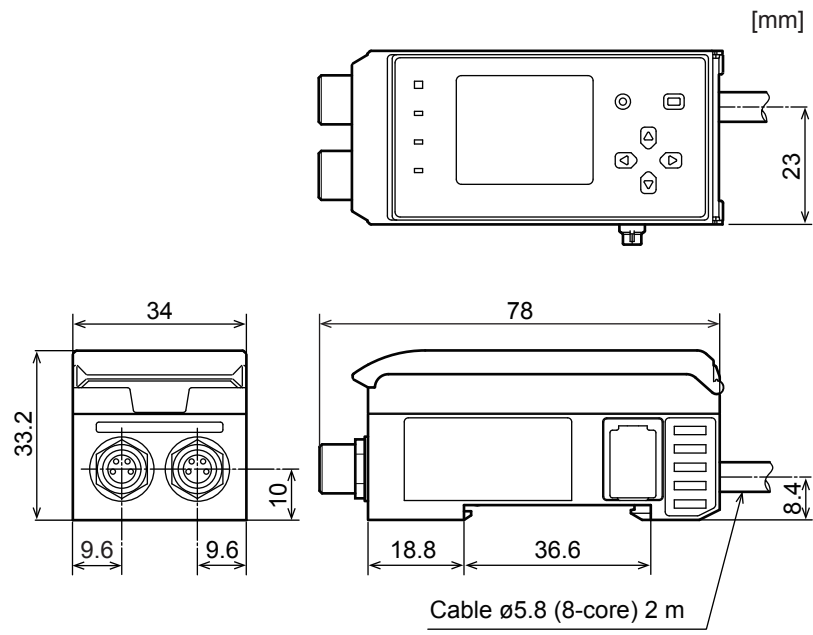

4-8-3 I/O Circuit Diagrams

● CDA-M/S

With the NPN output setting

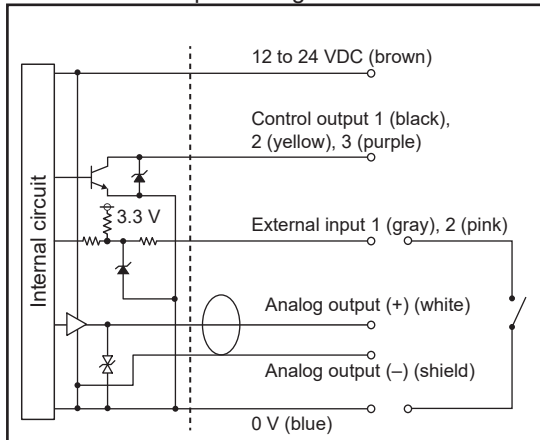

With the PNP output setting

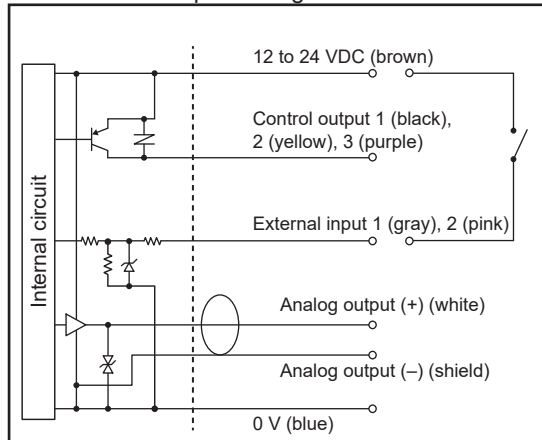

● CDA-DM2

With the NPN output setting

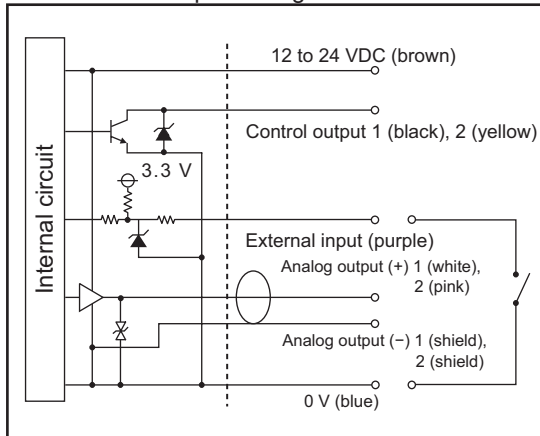

With the PNP output setting

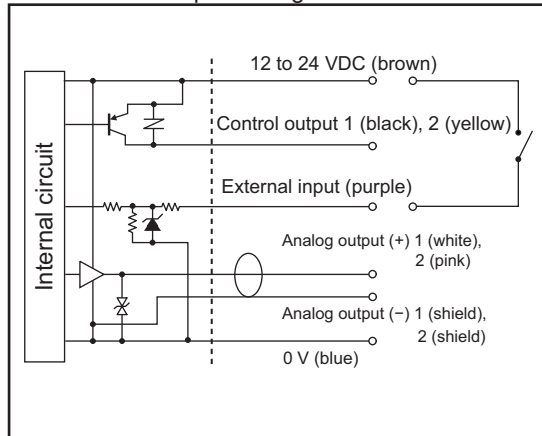

* For analog output (+) and analog output (-), use a shield cable and wire in pairs connecting to the analog input device.



5

Appendix

The appendix contains information, such as troubleshooting, that is useful to know during operation.

5-1 Troubleshooting

This section explains how to check for problems.

5-1-1 Status Indicator Specifications

The LED indicators on the CDA display the operations status as shown below.

■ PWR (power indicator)

LED status	CDA status	Countermeasures	Reference
Lit (green)	<ul style="list-style-type: none">• Power on• Normal operation		
Flashing	In power-saving mode	Press any key to make the display panel light.	
Lit (red)	Error	Check for an error in the connection to the power supply or to the sensor.	1-5 1-8
Off	Power off	Check the connection to the power supply.	1-8

■ OUT1/OUT2/OUT3 (control output indicators)

LED status	CDA status	Countermeasures	Reference
Lit (orange)	Assigned output on		
Off	Assigned output off		

If an unexpected operation occurs, check [I/O Settings] under [AMP Settings].

Displacement sensor amplifier unit

CDA-DM2

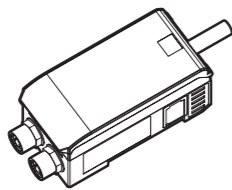
OPTEX FA CO.,LTD.

- Thank you for purchasing the CDA-DM2 displacement sensor amplifier unit.
- Before using this product, please read this manual carefully to ensure proper use.
- Read this manual thoroughly, and then keep this manual at hand so that it can be used whenever necessary.
- The warranty period of this product is one year after delivery. However, any fault attributable to natural disasters or any other similar disasters or modification or repair will be excluded from the scope of the warranty.

Safety Precautions

Safety precautions for ensuring safe operation of this product are displayed as follows with the following symbols.

Precautions listed here describe important information about safety. Make sure to follow them accordingly.

Safety Symbols

	WARNING	Indicates that any improper operation or handling may result in moderate or minor injury, and in rare cases, serious injury or death. Also indicates a risk of serious property damage.
	CAUTION	Indicates that any improper operation or handling may result in minor injury or property damage.

WARNING	
	Do not disassemble, repair, modify, deform under pressure, or attempt to incinerate this product. Doing so may cause injury or fire.
	This product is not explosion-proof and should not be used around flammable or explosive gases or liquids. Doing so may cause ignition resulting in an explosion or fire.
	Do not use air dusters or any spray that uses flammable gas around the product or on the inside of the product. Doing so may cause ignition resulting in an explosion or fire.
	Do not install this product in any of the following locations. Doing so may cause a fire, damage, or a malfunction. <ol style="list-style-type: none"> 1. Locations where dust, salt, iron powders, or vapor (steam) is present. 2. Locations subjected to corrosive gases or flammable gases. 3. Locations where oil or chemical splashes may occur. 4. Locations where heavy vibrations or impacts may occur. 5. Locations where the ambient temperature exceeds the rated range. 6. Locations subject to rapid temperature changes (or where condensation occurs). 7. Locations with strong electric or magnetic fields. 8. Outdoor locations or locations subject to direct light.
	Do not use this product in a non-industrial setting. Doing so may cause induction or radiation interference.
	This product is not intended for use with nuclear power, railways, aviation, vehicles, medical equipment, food-handling equipment, or any application where particular safety measures are required. Absolutely do not use this product for any of these fields.
	This product cannot be used in applications that directly or indirectly detect human bodies for the purpose of ensuring safety. Do not use this product as a detection device for protecting the human body.
	What to do in the event of a malfunction such as smoke being emitted from the product if you detect any malfunction including emission of smoke, abnormal smells or sounds, or the body becoming very hot, immediately stop operating the product and turn off the sensor power. Failure to do so may cause a fire. Repairing the product is dangerous and should in no way be performed by the customer. Contact an OPTEX FA sales representative for repairs.

CAUTION	
	Make sure to turn the power off before wiring the cable or connecting/disconnecting the connector. Connecting or disconnecting while energized may damage the product or cause electric shock.
	Avoid using the transient state while the power is on (100 ms). Output could become unstable, causing unexpected operation.
	Do not wire with high voltage cables or power lines. Doing so may cause malfunction or damage by induction.
	Do not bend the cable when below the freezing point. This may cause the cable to break.
	Do not drop the product or subject the product to strong impacts. Doing so may damage the product.
	Follow the instructions in this manual or the specified instruction manual when wiring the product or the dedicated controller for the correct wiring method. Incorrect wiring can damage the product or the controller, or cause a malfunction.
	When disconnecting the connector, be careful not to touch the terminals inside the connector, and do not allow foreign objects to enter the connector.
	Install this product as far away as possible from high-voltage equipment, power equipment, equipment that generates large switching surges, inverter motors, welders, or any equipment that can be a source of noise.
	When connecting or disconnecting the cable, make sure to hold it by the connector portion, and do not apply excessive force to the cable.

Handling Precautions

- After carefully considering the intended use, required specifications, and usage conditions, install and use the product within the specified ranges.
- All specifications may be changed without notice.
- When using this product, it is the responsibility of the customer to ensure necessary safety designs in hardware, software, and systems in order to prevent any threat to life, physical health, and property due to product malfunction or failure.
- Do not use this product for the development of weapons of mass destruction, for military use, or for any other military application. Moreover, if this product is to be exported, comply with all applicable export laws and regulations, including the "Foreign Exchange and Foreign Trade Act" and the "Export Administration Regulations," and carry out the necessary procedures pursuant to the provisions therein.
- For more details on conformity to the Restriction of Hazardous Substances Directive for this product, please contact an OPTEX FA sales representative. Before using this product, fully examine the applicable environmental laws and regulations, and operate the product in conformity to such laws and regulations. OPTEX FA does not assume any responsibility for damages or losses occurring as a result of noncompliance with applicable laws and regulations.
- Detection characteristics and digital display values may vary depending on the state of the target object and variations among individual products.

1. Included Accessories

Confirm that the following accessories are included in the box.

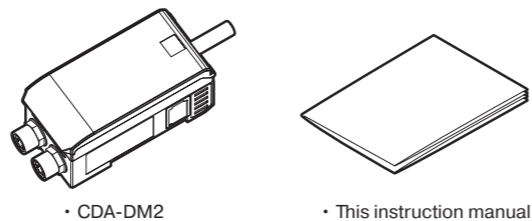

2. Dimensions

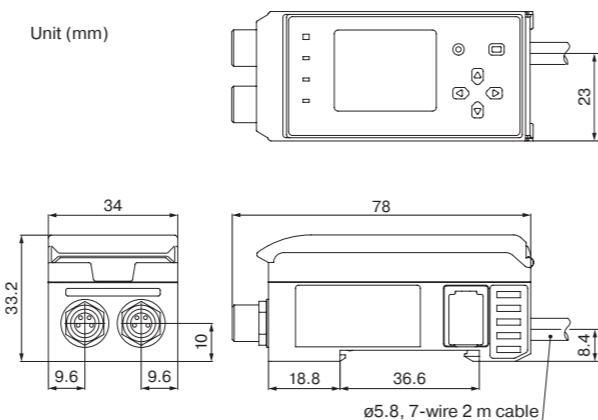

[M8 connector]

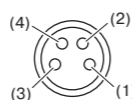

Pin No.	Function
(1)	12 to 24 VDC ±10%
(2)	RS-485 (B)
(3)	0 V
(4)	RS-485 (A)

3. I/O Circuit Diagram

The input/output circuits of this unit are as follows. Use the settings to switch between NPN and PNP outputs.

With the NPN output setting

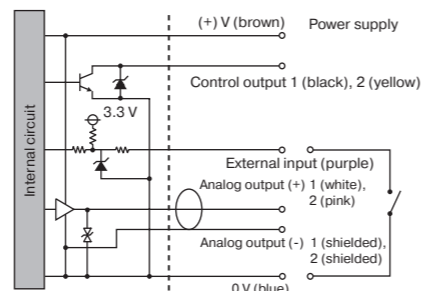

With the PNP output setting

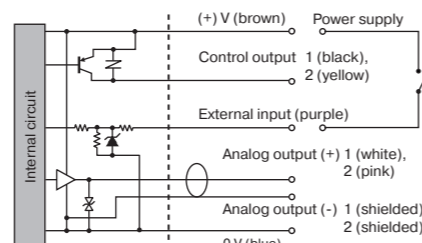

* Use shielded cables for analog output (+) and analog output (-), and wire as a pair up to the analog input device.

4. Part Names

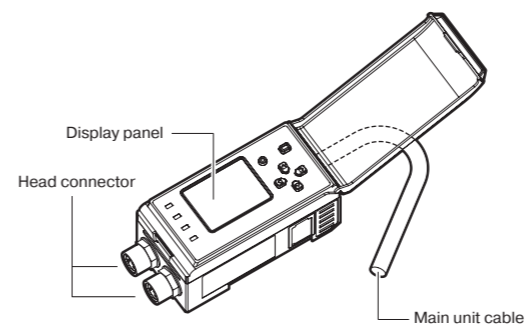

Operating panel

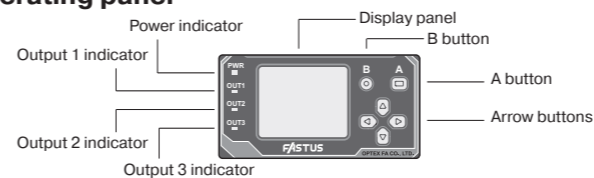

Indicators

Name	Color	Indication
Power supply	Green/Red	Green: Power on Red: Head communication error Flashing: In power-saving mode
Output 1 indicator	Orange	Lit: Output 1 ON Not lit: Output 1 OFF
Output 2 indicator	Orange	Lit: Output 2 ON Not lit: Output 2 OFF
Output 3 indicator	Orange	Lit: Output 3 ON Not lit: Output 3 OFF

5. Basic Operations

Button types and operations

Button shape	Name	On-screen display	Function
	A button		Quick press (less than 2 sec.): "Set" Long press (2 sec. or more): "Finish"
	B button		"Cancel"
	Up/down buttons		Select item; Increase/decrease value
	Left/right buttons		Select menu

Screen image

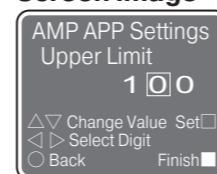

* The language selection screen is displayed when the power is turned on for the first time. Use to select the desired language, and press (A button) to confirm the selection.

* The language can be changed at any time from the "Expert Mode" menu.

6. Functions

Power-save display

If no button operation is detected for 10 minutes, the settings and measurement displays will turn off.

During this period, the PWR LED (power indicator) will flash every second. Pressing any button will return the display to normal. Return operation is also possible when the keys are locked.

External input

Functions such as offset execution can be assigned to external inputs. Assigned functions will work simultaneously on the Ch 1 and Ch 2 heads.

High-accuracy analog output

The CDA-DM2 is equipped with two 16-bit resolution analog output circuits. The voltage and current for each analog output can be independently switched as desired, and output values can be specified as measurement values or calculation results for each channel as desired.

For details, see the CDA series user's manual.

Key lock/unlock

Press and hold (B button) for at least 2 seconds on the measurement screen or calculation results display screen to lock the keys.

While the keys are locked, "Key Locked" is displayed at the bottom of the measurement screen.

Press and hold (B button) again for at least 2 seconds to unlock the keys.

7. Connectable Devices

Compatible sensor heads

- TD1 series through-beam edge sensor
- CD22 series compact laser displacement sensor (RS-485 communication type)
- CDX series ultra high-accuracy laser displacement sensor

* For connection details, see the instruction manual for the specific sensor head.

Communication units

- UC1 series communication unit
- CDA-S displacement sensor amplifier unit (slave unit)

* For connection details, see the instruction manual for the specific unit.

8. Specifications

Model	CDA-DM2 (Master unit)	
Mounting method	DIN rail mounting	
Sensor head	Max. number of connections	2 units
	Connector	M8, 4-pin
	Protocol	RS485-compliant (max. length of extension cable: 10 m)
	Display	128 × 96 dot matrix display; Japanese/English (selectable)
I/O	External input	1 input (enabled for Ch 1 and Ch 2)
	Control output	2 outputs, PNP/NPN selectable; Open collector; 24 VDC / 100 mA or less; Residual voltage: 1.8 V or less
Ratings	Supply voltage	12 to 24 VDC ±10%
	Current consumption	120 mA or less (at 12 V) *1
Environmental resistance	Protection circuit	Reverse connection protection, overcurrent protection
	Degree of protection	IEC standard, IP50
	Ambient temperature/humidity	-20 to +50°C / 35 to 85% RH (no freezing or condensation)
	Storage temperature/humidity	-20 to +60°C / 35 to 85% RH (no freezing or condensation)
	Vibration resistance	10 to 55 Hz; double amplitude 1.5 mm; 2 hours in each of the X, Y, and Z directions
Shock resistance	500 m/s ² (approx. 50 G); 3 times in each of the X, Y, and Z directions	
Material	PC	
Weight	170 g	

*1: Does not include current supplied to any connected sensor head or slave unit.

- Support for the China RoHS directive
- For details on the support for the China RoHS directive, see the following website.
https://www.optex-fa.jp/rohs_cn/

OPTEX FA CO.,LTD.

[Headquarters]

91 Chudoji-Awata-cho Shimogyo-ku Kyoto 600-8815 JAPAN

TEL +81-75-325-1314 FAX +81-75-325-2936

<https://www.optex-fa.com>

Amplifier for displacement sensor

FASTUS

CDA Series

CDA- □

Instruction manual

- Thank you for purchasing. We hope you are satisfied with its performance.
- Please read this manual carefully and keep it for future reference.

! Indicates a possible hazard that may result in death, serious injury, WARNINGS or serious property damage if the product is used without observing the stated instructions.

! **Warning Mandatory Requirements**

- This product is not an explosion proof construction. Do not use the product under flammable, explosive gas or liquid environment.
- Use of controls or adjustments or performance of procedures other than those specified herein may result in hazardous radiation exposure.
- Never use these products as sensing devices for personnel protection. Doing so could lead to serious injury or death. These sensors do not include the self-checking redundant circuitry necessary to allow their use in personnel safety applications. A sensor failure or malfunction can cause either an energized or de-energized sensor output condition. Please consult our distributors about safety products which meet OSHA, ANSI and IEC standards for personnel protection.

! **Warning Safety Precautions**

- It is dangerous to wire or attach/remove the connector while the power is on. Make sure to turn off the power before operation.
- Installing in the following places may result in malfunction:
 - A dusty or steamy place
 - A place generating corrosive gas
 - A place directly receiving scattering water or oil.
 - A place suffered from heavy vibration or impact.
- The product is not designed for outdoor use.
- Do not use the sensor in a transient state at power on (Approx. 15min. Warm up period)
- Do not wire with the high voltage cable or the power lines. Failure to do this will cause malfunction by induction or damage.
- Do not use the product in water.
- Operate within the rated range.
- Don't bend the cable when the temperature of the cable or atmosphere is below freezing.
- Wipe off dirt on the emitting/receiving parts to maintain correct detection. Also, avoid direct impact on the product.

Included items

Please confirm following items are included in the package.

- CDA- □
- This instruction manual

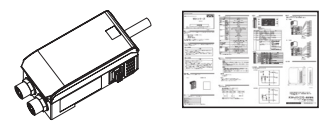

Specifications

Model	Master		Slave
	CDA-M	CDA-DM	CDA-S
Mounting	35mm DIN rail		
Sensor head	Max. number	2 units	
	Connector	M8, 4 pin connector	
Display	X, Y Pixels	X=128, Y=96 pixels	
	Indicator	Power indicator: Red / Green, Output indicator: Orange	
Analog Output	Current type:	4~20mA, Max. load resistance: 300Ω	
	Voltage type:	0~10V	
I/O	Ext. Input	2 inputs	2 inputs
	Control Output	3 NPN/PNP Open collector outputs, 30VDC 100mA Max. (Residual voltage 1.8V Max.)	
Communication I/F	RS-485 (Max. length 10m)		
Power supply	DC12~24V ± 10% (※)		
Current consumption	100mA Max./12VDC		
Protection circuit	Reverse connection protection		
Protection category	IP50		
Operating Temp/ Humid.	-20 ~ 50°C / 35 ~ 85% RH without freezing or condensation		
Storage Temp/ Humid.	-20 ~ 60°C / 35 ~ 85% RH without freezing or condensation		
Vibration resistance	10 ~ 55Hz, Double amplitude 1.5mm, X,Y,Z for 2 hours		
Shock resistance	500mm/s ² (approx. 50G), X,Y,Z 3 times each		
Material	PC		
Weight	170g		

(※) Power supply of slave (CDA-S) is provided by master

Connection diagram

You can switch between NPN and PNP for input and output interface by settings.

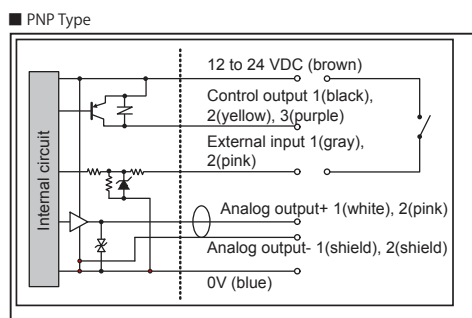
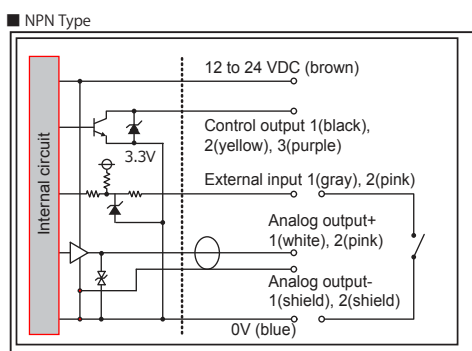

※ External inputs 1, 2 are only for CDA-M, CDA-S
※ Analog output 2 is only for CDA-DM

Names of parts

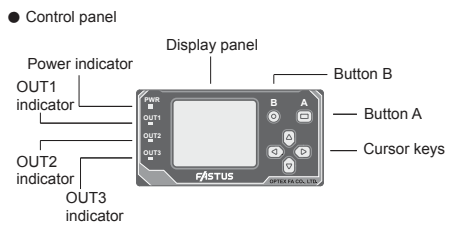
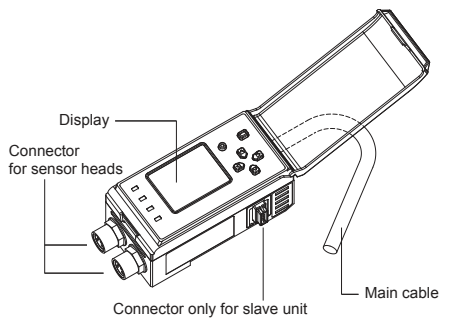

Indicator	Color	Description
Power indicator	Green or Red	Green ON: Running in normal mode Green blinking: Display is eco-mode Red ON: It has some Errors
Out 1 indicator	Orange	Orange ON: Output 1 is ON
Out 2 indicator	Orange	Orange ON: Output 2 is ON
Out 3 indicator	Orange	Orange ON: Output 3 is ON

Dimensions

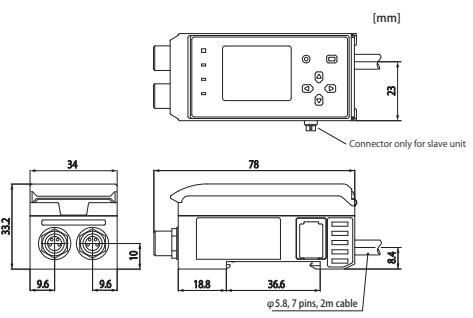

Functions of buttons

●Buttons

Shape	Name	On the display	Function
□	Button A	□	Mainly "Set" by clicking
		■	Mainly "Finish" by pressing hold
○	Button B	○	Mainly "Cancel"
△▽	Cursor Keys	△▽	Up/Down of parameter, Selecting parameter
		◀▶	Selecting menu

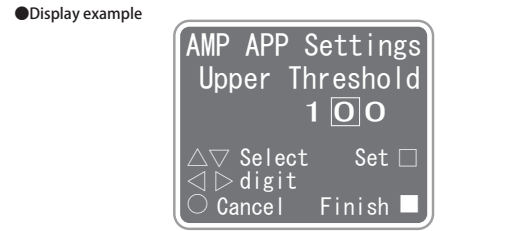

* It will show Language selecting menu for the 1st time of power up. Select by the cursor keys △▽, then set by button □ (button A).

Other functions

- Language selecting menu**
To go to the Language selecting menu, power up while pressing hold the button ○ (button B).
- Key lock / Releasing lock**
While the mode is Measurement mode or Measurement result display mode, by pressing the button ○ (button B) for more than 2 seconds, then buttons and keys will be locked. It will show "Key lock" at the bottom of the display.
From "Key lock" status, press hold the button ○ (button B) for more than 2 seconds, then it will release the buttons and keys.
- Specifications and equipment are subject to change without any prior notice.**
- For more information, questions and comments regarding products, please contact us below.**

→ http://www.optex-fa.com/rohs_cn/

Manufactured and sold by :

OPTEX FA CO.,LTD.

91 Chudoji-Awata-cho Shimogyo-ku Kyoto 600-8815 JAPAN
TEL : +81-(0)75-325-1314
FAX: +81-(0)75-325-2936
Website : <http://www.optex-fa.com>