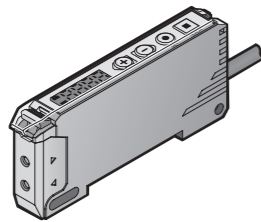

Digital Fiber Amplifier

D1RF-T Series

D1RF-T
D1RF-TC

OPTEX FA CO., LTD.

- Thank you for purchasing this Digital Fiber Amplifier D1RF.
- Before using this product, please read this manual carefully to ensure proper use.
- Read this manual thoroughly, and then keep this manual at hand so that it can be used whenever necessary.
- The warranty period of this product is one year after delivery. However, any fault attributable to natural disasters or any other similar disasters or modification or repair will be excluded from the scope of the warranty.

Safety Precautions

Safety precautions for ensuring safe operation of this product are displayed as follows with the following symbols.

Precautions listed here describe important information about safety. Make sure to follow them accordingly.

Safety Symbols

	WARNING Indicates that any improper operation or handling may result in moderate or minor injury, and in rare cases, serious injury or death. Also indicates a risk of serious property damage.
	CAUTION Indicates that any improper operation or handling may result in minor injury or property damage.

WARNING	
	Do not disassemble, repair, modify, deform under pressure, or attempt to incinerate this product. Doing so may cause injury or fire.
	This product is not explosion-proof and should not be used around flammable or explosive gases or liquids. Doing so may cause ignition resulting in an explosion or fire.
	Do not use air dusters or any spray that uses flammable gas around the product or on the inside of the product. Doing so may cause ignition resulting in an explosion or fire.
	Do not install this product in any of the following locations. Doing so may cause a fire, damage, or a malfunction. 1. Locations where dust, salt, iron powders, or vapor (steam) is present. 2. Locations subjected to corrosive gases or flammable gases. 3. Locations where oil or chemical splashes may occur. 4. Locations where heavy vibrations or impacts may occur. 5. Locations where the ambient temperature exceeds the rated range. 6. Locations subject to rapid temperature changes (or where condensation occurs). 7. Locations with strong electric or magnetic fields. 8. Outdoor locations or locations subject to direct light.
	This is a class A product. In a domestic environment this product may cause radio interference, in which case the user may be required to take adequate measures.
	This product is not intended for use with nuclear power, railways, aviation, vehicles, medical equipment, food-handling equipment, or any application where particular safety measures are required. Absolutely do not use this product for any of these fields.
	This product cannot be used in applications that directly or indirectly detect human bodies for the purpose of ensuring safety. Do not use this product as a detection device for protecting the human body.
	What to do in the event of a malfunction such as smoke being emitted from the product If you detect any malfunction including emission of smoke, abnormal smells or sounds, or the body becoming very hot, immediately stop operating the product and turn off the sensor power. Failure to do so may cause a fire. Repairing the product is dangerous and should in no way be performed by the customer. Contact an Optex FA sales representative for repairs.

CAUTION	
	Make sure to turn the power off before wiring the cable or connecting/disconnecting the connector. Connecting or disconnecting while energized may damage the product or cause electric shock.
	Avoid using the transient state while the power is on (100 ms). Output could become unstable, causing unexpected operation.
	Do not wire with high voltage cables or power lines. Doing so may cause malfunction or damage by induction.
	Do not bend the cable when below the freezing point. This may cause the cable to break.
	Do not drop the product or subject the product to strong impacts. Doing so may damage the product.
	Follow the instructions in this manual or the specified instruction manual when wiring the product or the dedicated controller for the correct wiring method. Incorrect wiring can damage the product or the controller, or cause a malfunction.
	When disconnecting the connector, be careful not to touch the terminals inside the connector, and do not allow foreign objects to enter the connector.
	Install this product as far away as possible from high-voltage equipment, power equipment, equipment that generates large switching surges, inverter motors, welders, or any equipment that can be a source of noise.
	When connecting or disconnecting the cable, make sure to hold it by the connector portion, and do not apply excessive force to the cable.

NOTICE

- After carefully considering the intended use, required specifications, and usage conditions, install and use the product within the specified ranges.
- All specifications may be changed without notice.
- When using this product, it is the responsibility of the customer to ensure necessary safety designs in hardware, software, and systems in order to prevent any threat to life, physical health, and property due to product malfunction or failure.
- Do not use this product for the development of weapons of mass destruction, for military use, or for any other military application. Moreover, if this product is to be exported, comply with all applicable export laws and regulations, including the "Foreign Exchange and Foreign Trade Act" and the "Export Administration Regulations," and carry out the necessary procedures pursuant to the provisions therein.
- For more details on conformity to the Restriction of Hazardous Substances Directive for this product, please contact an Optex FA sales representative. Before using this product, fully examine the applicable environmental laws and regulations, and operate the product in conformity to such laws and regulations. Optex FA does not assume any responsibility for damages or losses occurring as a result of noncompliance with applicable laws and regulations.
- Detection characteristics and digital display values may vary depending on the state of the target object and variations among individual products.

1. Included Accessories

This instruction manual

2. Dimensions

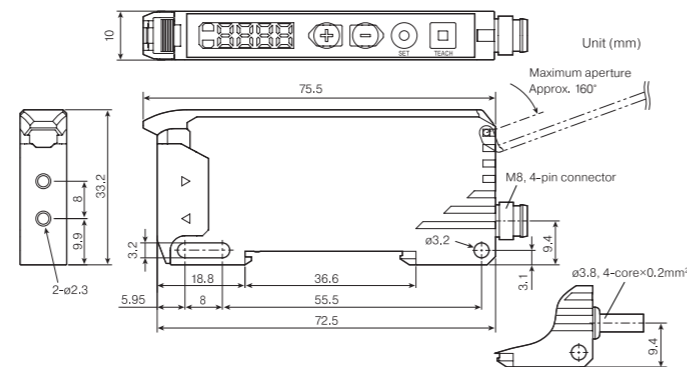

3. I/O Circuit Diagram

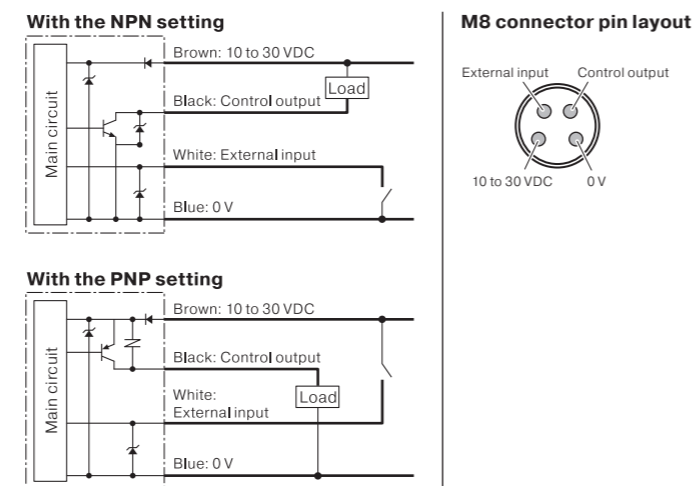

4. Mounting

When mounting screws, use M3 screws with a tightening torque of 0.5 N·m or less.

Mounting the amplifier (DIN-rail mounting)

Hook the fiber unit connector side tab to the DIN-rail (1), and press down until the hook locks (2).

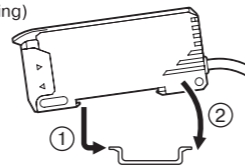

Removing the amplifier (DIN-rail mounting)

While pressing the amplifier body in the direction of (1), lift the fiber unit connector side to remove (2).

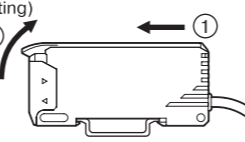

Mounting the fiber unit

Tilt the fiber lock lever (1), and insert the fiber through the insertion opening until it stops (2). Return the fiber lock lever to the stop position (3).

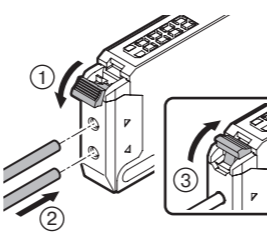

CAUTION

When using a coaxial reflective type fiber, install single-core fiber or fiber containing white wire on the emitting side, and multi-core fiber on the receiving side.



How to use the small diameter adapter

1. With the adapter cap turned all the way to the left, insert the fiber the necessary length and turn the adapter cap to the right to lock it.
2. Cut the unnecessary parts of the fiber with fiber cutters.

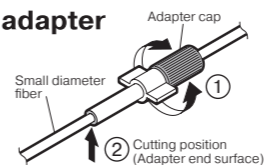

5. Part Names

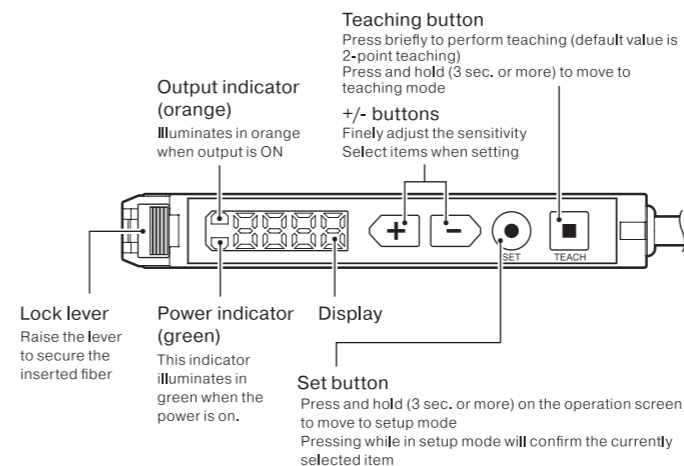

6. Teaching (Sensitivity Setting)

To perform teaching, first press the button for 3 sec. or more, then select teaching with the button, and confirm with the button. When teaching is performed, "good" will be displayed before returning to the operation mode.

Detect the presence/absence of workpieces (when teaching is possible in the present/absent state)

Configure teaching when workpieces are present and when they are absent. The threshold value is set and stored between the first and second points.

2-point teaching

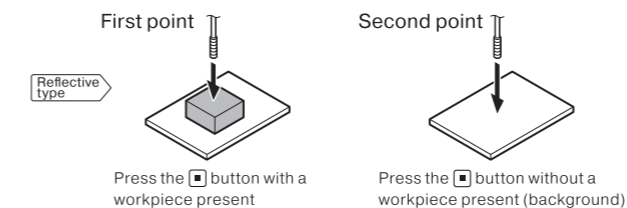

Resistant to dust and dirt

Ideal for long distance detection and detection in severe environments. The threshold value is set to the minimum value that can be stably detected.

1-point teaching

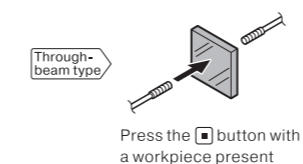

Switching within a fixed range

Ideal for detecting only within a fixed range of received light. The threshold value is set within the range of approx. ±10% the received light amount.

Zone teaching

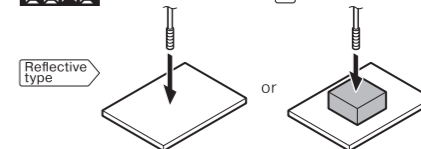

Press the button with no workpiece and just the background or with a workpiece present. * If performing with the background, same settings are applied with the background as the workpiece.

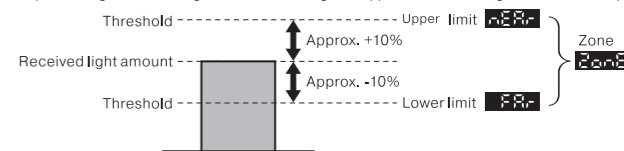

Teaching so the line does not stop

This can be applied when teaching so the line does not stop. The threshold value is set to be between the maximum value and minimum value from start to stop.

Auto-teaching

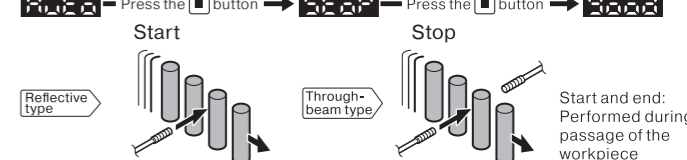

7. Threshold Adjusting Mode

Normally

Press the and buttons to adjust the threshold, and press the button to confirm. Returns to operation mode after confirming.

Threshold setting range: 4 to 9999 (using digital display) * Returns to operation mode if there is no operation for 5 seconds

Selecting zone teaching

[Upper limit setting] Press the and buttons to select (upper limit), and press the button to confirm. Continue by adjusting the threshold with the and buttons, and press the button to confirm. Returns to operation mode after confirming.

[Lower limit setting] Press the and buttons to select (lower limit), and press the button to confirm. Continue by adjusting the threshold with the and buttons, and press the button to confirm. Returns to operation mode after confirming.

Threshold setting range: 4 to 9999 (using digital display) * Returns to operation mode if there is no operation for 5 seconds

8. Switch to Setup/Teaching Mode

Move to the setup mode

Press the button for 3 sec. or more to move to setup mode.

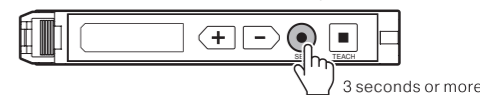

Move to the teaching mode

Press the button for 3 sec. or more to move to teaching mode.

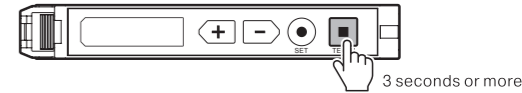

Return to RUN mode

Return to RUN mode without going to "End" by pressing the button in setup mode or the button in teaching mode for 3 sec. or more. [When in setup mode]

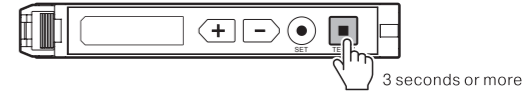

[When in teaching mode]

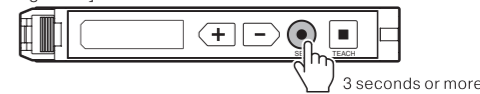

9. Menu List

Setup mode

Press the **SET** button for 3 sec. or more

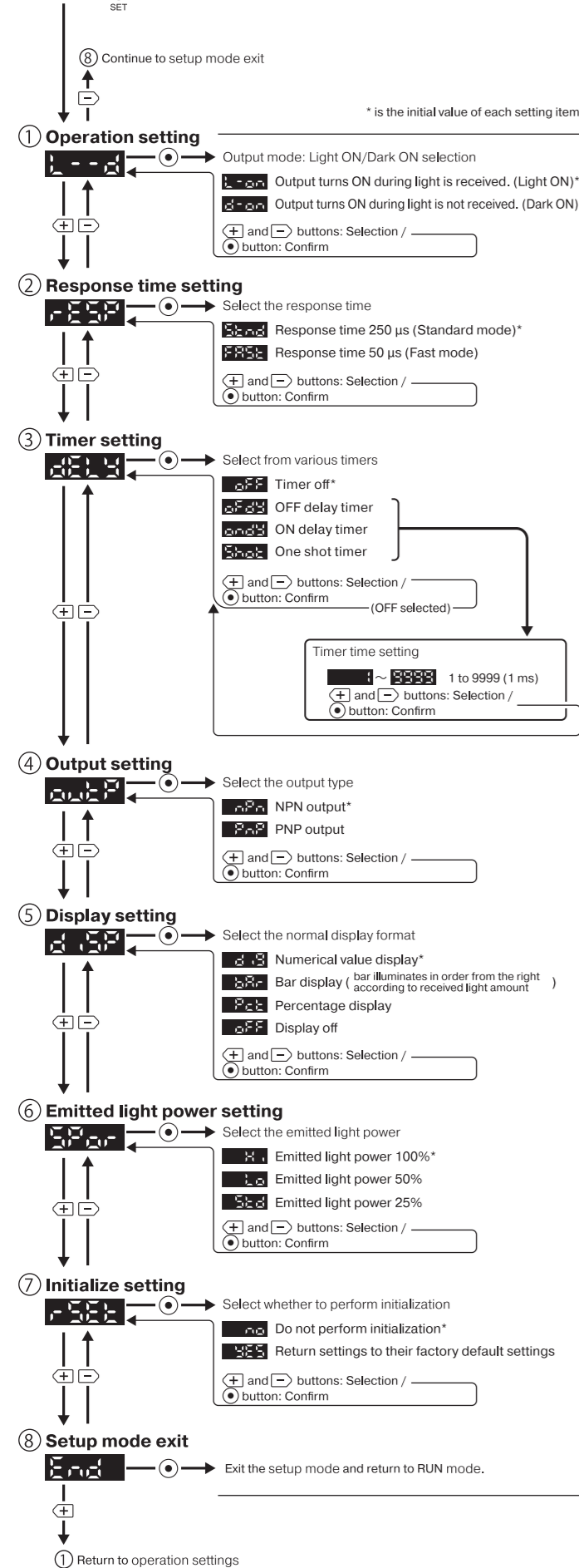

Teaching mode

Press the **TEACH** button for 3 sec. or more

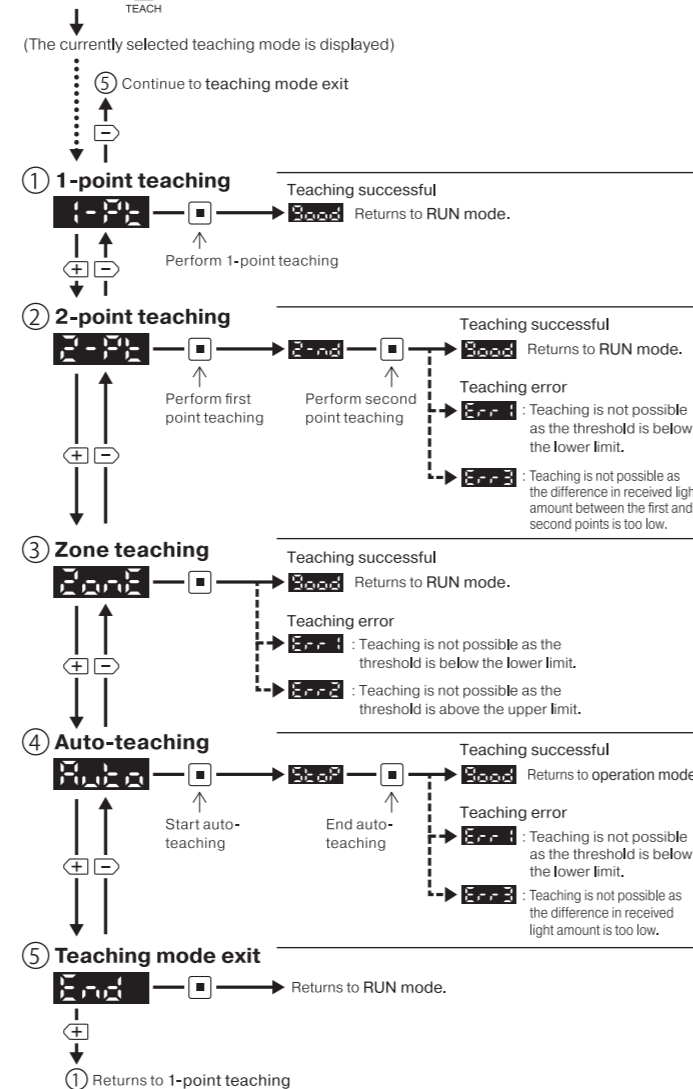

10. Convenient Functions

Initialize settings

All settings are returned to their factory default settings.

1. Press the **SET** button for 3 sec. or more to enter setup mode.
2. Press the **←** button twice to display **0.00**, and confirm with the **SET** button.
3. Display **0.00** with the **←** button, and perform initialization with the **SET** button.
4. Press the **TEACH** button for 3 sec. or more to return to normal mode.

* "Output setting" is not changed even if initialization is performed.

Prevent misoperation (key lock)

Disable key operation to prevent misoperation, etc. While in normal mode, press the **←** buttons simultaneously for 3 sec. or more. Key lock is canceled by performing the same operation.

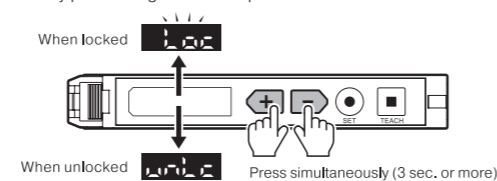

Display received light amount percentage

Sets the display as a percentage.

1. Press the **SET** button for 3 sec. or more to enter setup mode.
2. Press the **←** button four times to display **0.00**, and confirm with the **SET** button.
3. Display **0.00** with the **←** button, and set the percentage display with the **SET** button.
4. Press the **TEACH** button for 3 sec. or more to return to normal mode.

On the spot teaching (fast teaching)

Briefly press the **TEACH** button for 3 sec. or less

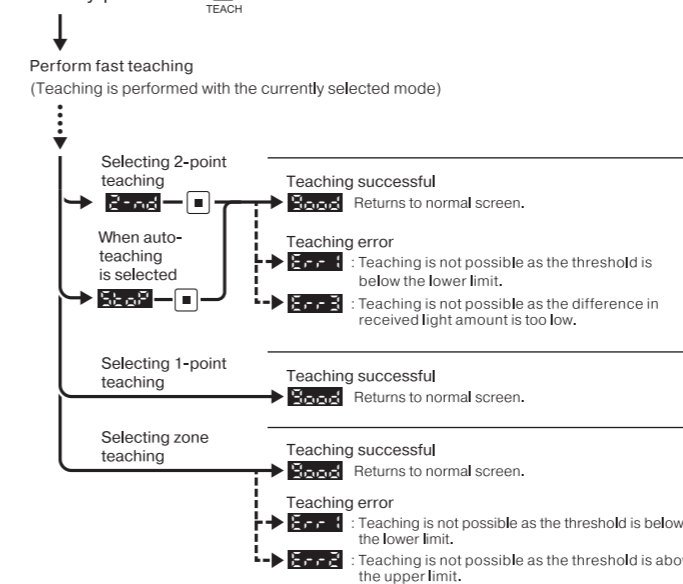

11. Details on External Teaching

When using external input for teaching, the teaching method can be selected according to input time. The conditions under which external input is turned ON differs depending on the output settings.

- With the NPN setting: ON at 0 V (blue) and short circuit
- With the PNP setting: ON at 10 V to 30 V (brown) and short circuit

* External teaching is cancelled if 8 sec. or more have passed with external input ON.

1-point teaching

- The received light amount is sampled when external input is turned ON.
- If external input turns OFF within 10 ms to 100 ms after it is turned ON, 1-point teaching is performed.

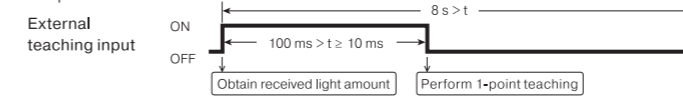

Zone teaching

- The received light amount is sampled when external input is turned ON.
- If external input turns OFF within 100 ms to 200 ms after it is turned ON, zone teaching is performed.

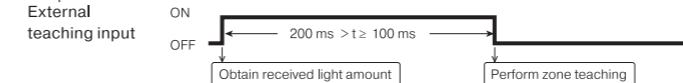

Auto-teaching

If the external input (or mf (multi function) input) is turned ON and then turned OFF within 200 ms to 500 ms, auto-teaching will be selected.

- After selecting auto-teaching, auto-teaching will start when the external input (or mf (multi function) input) is turned on.
- Auto-teaching will end when the external input (or mf (multi function) input) is turned OFF.

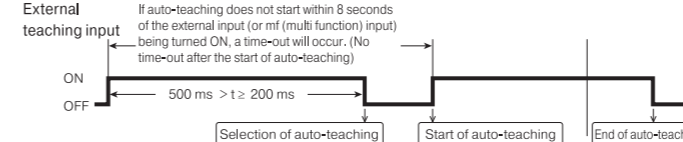

2-point teaching

If external input turns OFF more than 200 ms after it is turned ON, 2-point teaching is performed.

- The first teaching point is performed when the external input is turned ON.
- The second teaching point is performed when the external input is turned OFF.

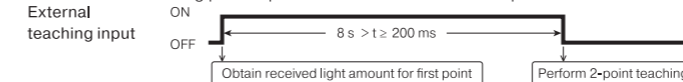

Minimum pulse period

Since there is an input filter time, set the minimum ON/OFF time to 10 ms or more.

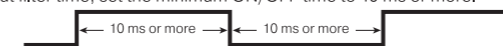

12. Specifications

Item	D1RF-T / D1RF-TC
Light source	Red LED
Supply voltage	10 to 30 VDC (including 10% ripple)
Current consumption (power)	40 mA max.
Response time	Standard: 250 μs Fast: 50 μs
Control output	NPN/PNP switched by setting, Open collector, 30 V / 100 mA, Residual voltage 1.8 V max.
External input	External teaching
Initialization time	100 ms
Sensitivity adjustment	Teaching, fine tuning with +/- buttons
Output mode	Light ON / Dark ON selectable
Indicators	Output indicator: Orange, Power indicator: Green
Digital display	7-segment, 4-digit display Received light amount / Threshold / Set value
Protection circuit	Reverse connection protection, Overcurrent protection, 30 V max.
Cross talk prevention	Max. 2 units
Degree of protection	IP66
Operating temperature/humidity	-25 to +55°C / 35 to 85% (no freezing or condensation)*2
Storage temperature/humidity	-40 to +70°C / 35 to 95% (no freezing or condensation)
Ambient illuminance	Sunlight: 10,000 lx or less, Incandescent light: 3,000 lx or less
Vibration resistance	10 to 55 Hz; Double amplitude 1.5 mm; 2 hours in each of the X, Y, and Z directions
Shock resistance	50 G (500 m/s ²), 3 times in each of the X, Y, and Z directions
Mounting	Machine screw: M3 × 2, Rail: 35 mm DIN-rail
Connection type	Cable type: 4-wire 2 m cable, Connector type: M8, 4-pin
Connection	1/Brown: 10 to 30 VDC, 2/White: External input, 3/Blue: 0 V, 4/Black: Control output
Material	Housing, cover: Polycarbonate (PC)
Outer dimensions	10 × 33.2 × 75.5 (mm)
Included accessory(ies)	Instruction manual
Options	Mounting bracket
Applicable regulation(s)	EMC EMC Directive (2014/30/EU) Environment RoHS Directive (2011/65/EU), China RoHS (MIIT Order No.32)
Applicable standard(s)	EN 60947-5-2

*1: Target 500 mm × 500 mm reflection rate 90%, when using fiber NF-DK06

*2: Up to 16 closely mounted units

Model naming rules

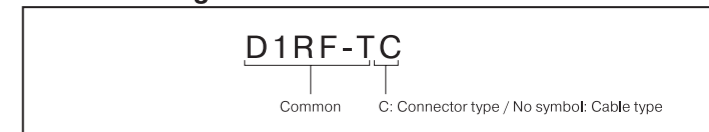

- Support for the China RoHS directive

10 For details on the support for the China RoHS (the Administrative Measure on the Control of Pollution Caused by Electronic Information Products), see the following website.
http://www.optex-fa.com/rohs_cn/

OPTEX FA CO., LTD.

[Headquarters]

91 Chudoji-Awata-cho Shimogyo-ku Kyoto 600-8815 JAPAN

TEL +81-75-325-1314 FAX +81-75-325-2936

<http://www.optex-fa.com>

Fiber Amplifier

V2RF Series

V2RF-P V2RF-CP
V2RF-N V2RF-CN

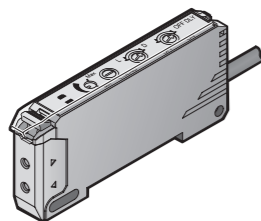

OPTEX FA CO.,LTD.

- Thank you for purchasing this Fiber Amplifier V2RF.
- Before using this product, please read this manual carefully to ensure proper use.
- Read this manual thoroughly, and then keep this manual at hand so that it can be used whenever necessary.
- The warranty period of this product is one year after delivery. However, any fault attributable to natural disasters or any other similar disasters or modification or repair will be excluded from the scope of the warranty.

Safety Precautions

Safety precautions for ensuring safe operation of this product are displayed as follows with the following symbols.

Precautions listed here describe important information about safety. Make sure to follow them accordingly.

Safety Symbols

	WARNING Indicates that any improper operation or handling may result in moderate or minor injury, and in rare cases, serious injury or death. Also indicates a risk of serious property damage.
	CAUTION Indicates that any improper operation or handling may result in minor injury or property damage.
	WARNING
	Do not disassemble, repair, modify, deform under pressure, or attempt to incinerate this product. Doing so may cause injury or fire.
	This product is not explosion-proof and should not be used around flammable or explosive gases or liquids. Doing so may cause ignition resulting in an explosion or fire.
	Do not use air dusters or any spray that uses flammable gas around the product or on the inside of the product. Doing so may cause ignition resulting in an explosion or fire.
	Do not install this product in any of the following locations. Doing so may cause a fire, damage, or a malfunction. 1. Locations where dust, salt, iron powders, or vapor (steam) is present. 2. Locations subjected to corrosive gases or flammable gases. 3. Locations where oil or chemical splashes may occur. 4. Locations where heavy vibrations or impacts may occur. 5. Locations where the ambient temperature exceeds the rated range. 6. Locations subject to rapid temperature changes (or where condensation occurs). 7. Locations with strong electric or magnetic fields. 8. Outdoor locations or locations subject to direct light.
	This is a class A product. In a domestic environment this product may cause radio interference, in which case the user may be required to take adequate measures.
	This product is not intended for use with nuclear power, railways, aviation, vehicles, medical equipment, food-handling equipment, or any application where particular safety measures are required. Absolutely do not use this product for any of these fields.
	This product cannot be used in applications that directly or indirectly detect human bodies for the purpose of ensuring safety. Do not use this product as a detection device for protecting the human body.
	What to do in the event of a malfunction such as smoke being emitted from the product If you detect any malfunction including emission of smoke, abnormal smells or sounds, or the body becoming very hot, immediately stop operating the product and turn off the sensor power. Failure to do so may cause a fire. Repairing the product is dangerous and should in no way be performed by the customer. Contact an Optex FA sales representative for repairs.

	CAUTION
	• Make sure to turn the power off before wiring the cable or connecting/disconnecting the connector. Connecting or disconnecting while energized may damage the product or cause electric shock.
	• Avoid using the transient state while the power is on (100 ms). Output could become unstable, causing unexpected operation.
	• Do not wire with high voltage cables or power lines. Doing so may cause malfunction or damage by induction.
	• Do not bend the cable when below the freezing point. This may cause the cable to break.
	• Do not drop the product or subject the product to strong impacts. Doing so may damage the product.
	• Follow the instructions in this manual or the specified instruction manual when wiring the product or the dedicated controller for the correct wiring method. Incorrect wiring can damage the product or the controller, or cause a malfunction.
	• When disconnecting the connector, be careful not to touch the terminals inside the connector, and do not allow foreign objects to enter the connector.
	• Install this product as far away as possible from high-voltage equipment, power equipment, equipment that generates large switching surges, inverter motors, welders, or any equipment that can be a source of noise.
	• When connecting or disconnecting the cable, make sure to hold it by the connector portion, and do not apply excessive force to the cable.

NOTICE

- After carefully considering the intended use, required specifications, and usage conditions, install and use the product within the specified ranges.
- All specifications may be changed without notice.
- When using this product, it is the responsibility of the customer to ensure necessary safety designs in hardware, software, and systems in order to prevent any threat to life, physical health, and property due to product malfunction or failure.
- Do not use this product for the development of weapons of mass destruction, for military use, or for any other military application. Moreover, if this product is to be exported, comply with all applicable export laws and regulations, including the "Foreign Exchange and Foreign Trade Act" and the "Export Administration Regulations," and carry out the necessary procedures pursuant to the provisions therein.
- For more details on conformity to the Restriction of Hazardous Substances Directive for this product, please contact an Optex FA sales representative. Before using this product, fully examine the applicable environmental laws and regulations, and operate the product in conformity to such laws and regulations. Optex FA does not assume any responsibility for damages or losses occurring as a result of noncompliance with applicable laws and regulations.
- Detection characteristics may vary depending on the state of the target object and variations among individual products.

1. Included Accessories

This instruction manual

2. Dimensions

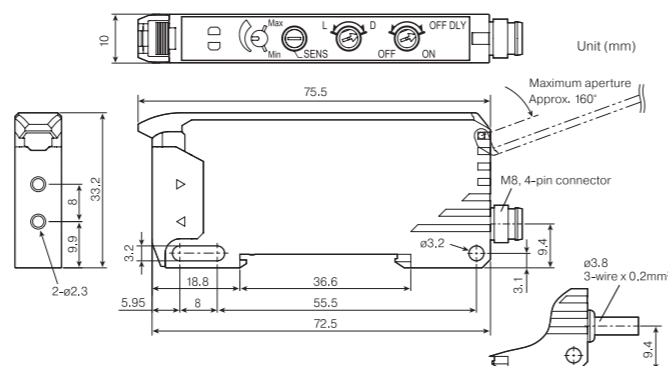

3. I/O Circuit Diagram

With the NPN setting

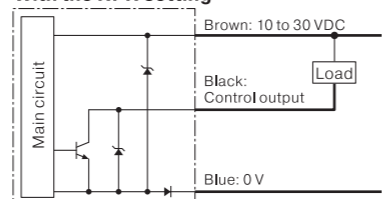

M8 connector pin configuration

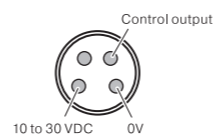

With the PNP setting

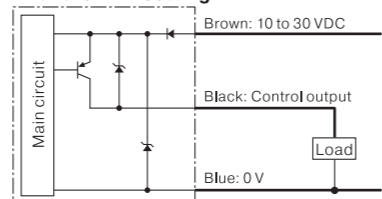

4. Mounting

When mounting screws, use M3 screws with a tightening torque of 0.5 N-m or less.

Mounting the amplifier (DIN-rail mounting)

Hook the fiber unit connector side tab to the DIN-rail ①, and press down until the hook locks ②.

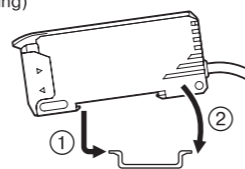

Removing the amplifier (DIN-rail mounting)

While pressing the amplifier body in the direction of ①, lift the fiber unit connector side to remove ②.

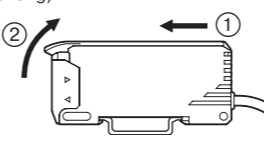

Mounting the fiber unit

Tilt the fiber lock lever ①, and insert the fiber through the insertion opening until it stops ②.

Return the fiber lock lever to the stop position ③.

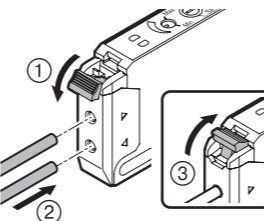

CAUTION

When using a coaxial reflective type fiber, install single-core fiber or fiber containing white wire on the emitting side, and multi-core fiber on the receiving side.



How to use the small diameter adapter

1. With the adapter cap turned all the way to the left, insert the fiber the necessary length and turn the adapter cap to the right to lock it.
2. Cut the unnecessary parts of the fiber with fiber cutters.

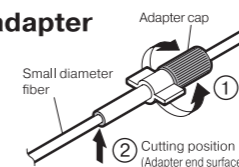

5. Part Names

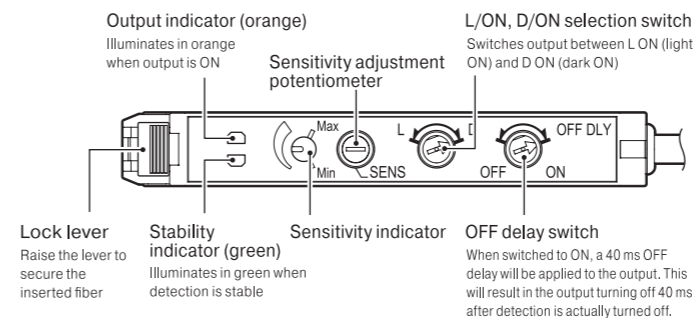

6. Sensitivity Adjustment

In the case of through-beam type fibers, usage at the maximum position of the sensitivity adjustment potentiometer is normally possible. If using reflective type fibers or when detecting semi-transparent objects, etc., using the through-beam type, adjust sensitivity using the following procedure.

1. Turn the sensitivity adjustment potentiometer to the left using a flathead screwdriver, etc., so that the sensitivity indicator is at the Min position.
2. Set the object for detection in the detection position and turn the sensitivity adjustment potentiometer to the right, gradually raising from the Min position. Position A is where the output indicator will light up.

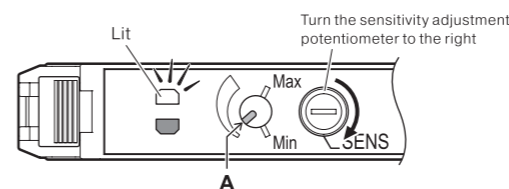

3. Turn the sensitivity adjustment potentiometer to the right so that the sensitivity indicator is at the Max position.
4. Remove the object for detection and turn the sensitivity adjustment potentiometer to the left, gradually lowering from the Max position. Position B is where the output indicator will go out.

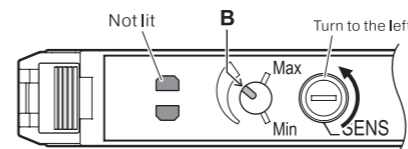

5. Position C between positions A and B is the optimal position for sensitivity.

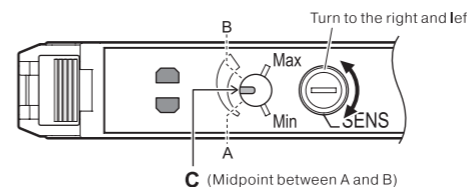

* Positions A and B may be reversed depending on the fiber model and the detection conditions.

7. Specifications

Item	V2RF-N (P)
Light source	Red LED
Supply voltage	10 to 30 VDC (including 10% ripple)
Current consumption (power)	30 mA max.
Response time	250 μs
Control output	NPN (PNP), Open collector, 30 V/100 mA, Residual voltage 1.8 V max.
Warm-up time	100 ms
Sensitivity adjustment	8-turn potentiometer with indicator
Mode switching	Selectable by switch
Timer	Fixed at 40 ms, selectable by switch
Indicators	Output indicator: Orange, Stability indicator: Green
Protection circuit	Reverse connection protection, Overcurrent protection, 30 V max.
Cross talk prevention	Max. 2 units
Degree of protection	IP66
Ambient temperature/humidity	-25 to +55°C / 35 to 85% (no freezing or condensation)*
Storage temperature/humidity	-40 to +70°C / 35 to 95% (no freezing or condensation)
Ambient illuminance	Sunlight: 10,000 lx or less, Incandescent light: 3,000 lx or less
Vibration resistance	10 to 55 Hz; Double amplitude 1.5 mm; 2 hours in each of the X, Y, and Z directions
Shock resistance	50 G (500 m/s ²), 3 times in each of the X, Y, and Z directions
Mounting	Machine screw: M3 × 2, Rail: 35 mm DIN-rail
Connection type	Cable type: 3-wire 2 m cable, Connector type: M8, 4-pin
Connection	1/Brown: 10 to 30 VDC, 3/Blue: 0 V, 4/Black: Control output
Material	Housing, cover: Polycarbonate (PC)
Outer dimensions	10 × 33.2 × 75.5 (mm)
Included accessories	Instruction manual
Options	Mounting bracket
Applicable regulations	EMC EMC directive (2014/30/EU) Environment RoHS directive (2011/65/EU), China RoHS (Directive No. 32)
Applicable standards	EN 60947-5-2

*: Conditions vary depending on the number of closely mounted units.
1 to 2 units: -25 to +55°C, supply voltage 30 V, output current 100 mA
3 to 10 units: -25 to +50°C, supply voltage 24 V, output current 100 mA
11 to 16 units: -25 to +50°C, supply voltage 24 V, output current 20 mA

Model naming rules

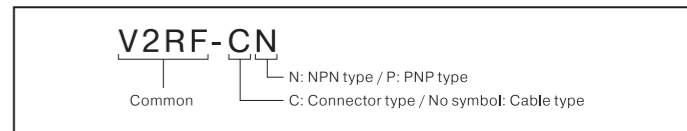

- Support for the China RoHS directive

For details on the support for the China RoHS directive (the Administrative Measure on the Control of Pollution Caused by Electronic Information Products), see the following website.
http://www.optex-fa.com/rohs_cn/

OPTEX FA CO.,LTD.

[Headquarters]
91 Chudoji-Awata-cho Shimogyo-ku Kyoto 600-8815 JAPAN
TEL +81-75-325-1314 FAX +81-75-325-2936

<http://www.optex-fa.com>